

Air Quality Division

Air Monitoring
&
Quality Assurance
Program

555 Cordova St
Anchorage, AK 99501

Phone: (907) 269-7577

Fax: (907) 269-7508

www.state.ak.us/dec/



Standard Operating Procedure
for
Met One Instruments, Inc.
Beta Attenuation Monitor
Model 1020
May 2020
Revision 1

This page intentionally left blank.

Acknowledgement

The Alaska Department of Environmental Conservation (ADEC), Division of Air Quality adapted the Standard Operating Procedures written by State of California, Air Resources Board (CARB)¹ and David Vaughn of Sonoma Technology, Inc². to fit the State of Alaska's needs. ADEC also acknowledges the equipment manufacturer, Met One Instruments, Inc., for providing images and extracts from their Operation Manual for use herein.

¹“Standard Operating Procedures for Met-One Instruments Beta Attenuation Mass Monitor (BAM-1020),” California Air Resources Board, Air Quality Surveillance Branch, Monitoring and Laboratory Division, June 2003.

²Vaughn, David. “Standard Operating Procedure for the Continuous Measurement of Particulate Matter, Met One BAM-1020 PM_{2.5} Federal Equivalent Method EQPM-0308-170, STI-905505.05-3645-SOP, Sonoma Technology, Inc., August 2009.

Table of Contents

Introduction.....	6
Organization.....	6
Principle of Operation	6
Safety Precautions.....	6
Interferences and Limitations.....	7
Moisture.....	7
Reference Membrane	7
Using the Keypad and Display.....	7
Sampling	9
Routine Maintenance and Operational Checks	9
Audits.....	11
Transfer Standards.....	12
Changing the Filter Tape.....	12
Cleaning the nozzle, vane, pinch rollers, and membrane.....	13
Leak test	13
Flow Check (Ambient Temperature, Barometric Pressure, and Volumetric Flow Verification) .	14
Calibrate Ambient Temperature (AT), Barometric Pressure (BP), and Volumetric Flow	15
Data Acquisition	17
Troubleshooting.....	17
BAM-1020 Acceptance, Siting, Installation, Configuration, and Calibration.....	17
Acceptance.....	17
Siting	18
Installation.....	20
Configuring Sample, Calibrate, Interface, Sensors, and Heater.....	24
Coarse pair setup.....	26
Additional Checks.....	26
Data Validation	26
Appendix A: Forms.....	27
Appendix B: Standards Traceability.....	30
Appendix C: Data Validation Template	32
MET ONE BETA ATTENUATION MONITOR (BAM) 1020 PM₁₀ & PM_{2.5}.....	33
Appendix D: Pump Information (Gast rotary type).....	38
Gast Series 23 Pump Operation & Maintenance Manual.....	39

Gast Pump Rebuild	47
--------------------------------	-----------

Tables & Figures

Figure 1. BAM Front Display Diagram	8
Figure 2. Touch Screen BAM Front Display Diagram.....	9
Table 1. Routine Maintenance Schedule	10
Table 2. Operational Checks.....	11
Table 3. Audit Information	11
Figure 3. Tape Loading Diagram.....	12
Table 4. Digital Communication Settings.....	17
Table 5. Acceptance Testing Procedures	18
Table 6. Siting Criteria.....	19
Table 7. Tool and Supply List for Installation.....	20
Figure 4. Electrical Connections.....	23
Table 8. Sample Parameters.....	24
Table 9. Other Settings	25
Table 10. ADEC BAM Channel Assignments & Configuration Settings	25
Table 11. Heater Settings.....	26
Table 12. Standards Traceability	31

Introduction

The purpose of this Standard Operating Procedure (SOP) is to document the Met One Instruments, Inc. (Met One) Beta Attenuation Monitor model 1020 (BAM-1020) procedures used by the State of Alaska Department of Environmental Conservation (ADEC). The goals of this SOP are to formalize BAM-1020 installation, configuration, and operation procedures to ensure comparability among all BAM-1020 data, and to describe modifications to the Met One BAM-1020 Operation Manual necessary to successfully integrate the BAM-1020 into the ADEC air monitoring network. The Met One BAM-1020 Operation Manual Revision W is the major source of information about the operation, maintenance, and understanding of this instrument and this SOP frequently references it. For touch screen BAMs, Met One has a separate operation manual titled BAM 1020-9803 REV L Operation Manual. The EPA-designated federal equivalent method (FEM) for the Met One PM₁₀ BAM is EQPM-0798-122, EPA-designated equivalent method for the Met One PM_{2.5} BAM is EQPM-0308-170. Some BAMs in the ADEC network are equipped with sharp cut cyclones (SCC) rather than very sharp cut cyclones (VSCC) and therefore are not operated according to all EPA FEM criteria. All BAMs in the network equipped with VSCCs are operated in accordance with FEM criteria.

Organization

The BAM-1020 installation procedures are located at the end of the SOP because they will not be referenced often. The maintenance and other sections are located at the front of the SOP because they will be required more frequently. The SOP focuses on standard operating procedures and contains no troubleshooting discussion or procedures; those are in the manufacturer's Operation Manual referenced above. In general, ADEC has adopted the manufacturer's procedures with some differences, and adheres to EPA specifications for individual operating, verification, and calibration tolerances.

Principle of Operation

A ¹⁴C element (<60 μCi) in the BAM-1020 emits a constant stream of beta particles (high-energy electrons) directed at the filter tape. The ambient particulate matter collected on the filter tape attenuate the beta rays and the decrease in signal detected by the BAM-1020 scintillation counter before and after collection is inversely proportional to the mass loading on the filter tape. The BAM-1020 uses the mass data along with flow measurements to calculate particulate concentrations in ambient air. The BAM-1020 calculates and reports these concentrations as hourly averages in units of ug/m³ or mg/m³. Pages 6 and 106 of the operation manual (Rev W) contain more details on operational theory.

Safety Precautions

Only properly trained personnel should perform BAM-1020 testing, installation, operation, maintenance, and calibration procedures. As with all monitoring equipment, personnel should take precautions when working around electricity, power tools, and on elevated platforms.

Personnel should never dismantle, remove, or tamper with the ^{14}C radioactive source. It will never be necessary for any field personnel to adjust, replace, or touch the ^{14}C source. All ^{14}C issues will be handled by the manufacturer either under warranty or at ADEC cost. When working close to the ^{14}C beta source for any length of time, wearing long sleeves and laboratory gloves may help reduce possible exposure to ^{14}C beta rays. The US EPA Code of Federal Regulations (CFR) allows no more than ten (10) BAM-1020 units at any one facility at one time. There are no restrictions or special requirements (such as licenses or permits) to ship, receive, or operate a BAM-1020 within the State of Alaska.

Interferences and Limitations

Moisture

The Met One BAM-1020 is a mass analyzer and any component that is suspended on the filter tape and attenuates beta rays will affect the average mass concentration value for that hour. To date, all BAM-1020 monitors operated by ADEC are equipped with an inlet heater kit which is crucial for most applications throughout the State of Alaska. The inlet heater should be set to Auto and will activate when the BAM-1020 internal relative humidity sensor detects inlet moisture content above 35%. Heat applied to the inlet tube warms the inlet air approximately $3\text{ }^{\circ}\text{C}$ to $5\text{ }^{\circ}\text{C}$ above the ambient air temperature. The slight elevation in temperature prevents inlet air moisture from condensing on the filter tape. The internal inlet %RH sensor is only used as a triggering device and should not be used or confused with external %RH data.

Reference Membrane

The reference membrane values generated during each hourly cycle are instrument drift values. Each BAM-1020 monitor comes from the factory with a data sheet that contains the calibration and membrane values unique to that instrument. The operator should keep this data sheet with the copy of the instrument manual. The “density”³ of the reference membrane for any particular BAM-1020 is listed on the line labeled "ABS" and is typically between 0.800 and 0.850 mg/cm^2 . Every 24 hours (hourly for older BAMs), the BAM-1020 automatically positions this membrane in the beta path and analyzes for instrument drift. The BAM-1020 integrates this membrane analysis and displays the result on the display screen as "LAST m:" during the following hour. The purpose of the membrane is only to monitor instrument drift from factory calibrations. The "LAST m:" value should not be used or confused with instrument span values which the BAM-1020 does not have the capability to analyze or report. If a "LAST m:" value differs more than $\pm 5.1\%$ from expected, then the operator should flag the mass data for that hour with a “D” (Deviant Membrane Density). This would indicate that the Reference Membrane was out of limits by more than $\pm 5.1\%$ (the BAM-1020 itself should detect this and generate a Deviant Membrane Density error).

Using the Keypad and Display

When the BAM-1020 is powered up it will display the main (top level) menu on the LCD display. Figure 1 shows this display for the non-touch screen BAMs. This menu is the starting point for all functions of the BAM-1020 user interface.

³ The dimensional unit which Met One uses for membrane density is mg/cm^2 (mass per unit area squared). While this is not technically a unit for density, Met One’s method does take into account the third dimension of membrane

thickness. It is a fixed value and the cross sectional density and path length are consistent within a narrow range that are compensated for with the careful selection of the mu value in the beta attenuation mass formula. (Dennis Hart, Met One, pers. comm.)

Figure 1. BAM Front Display Diagram

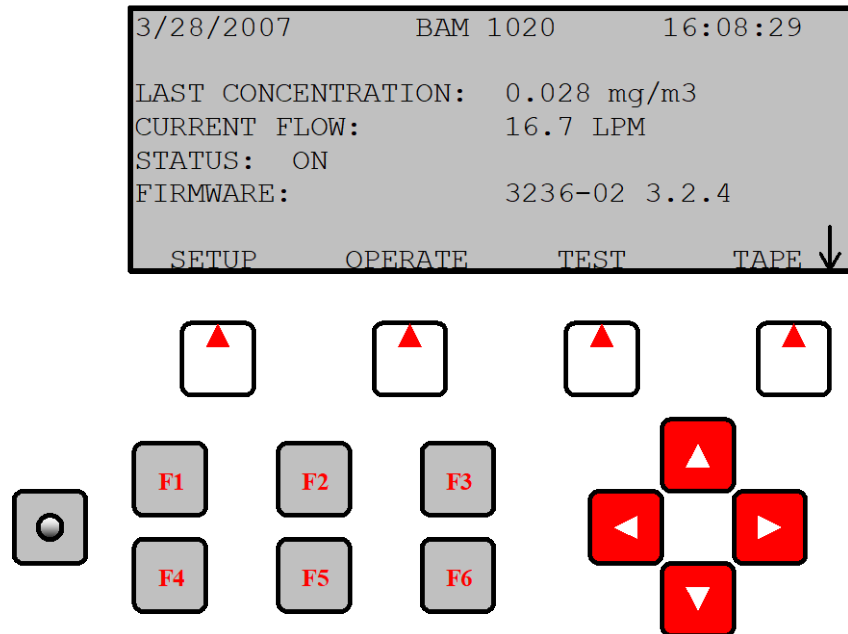

Non-Touch Screen BAM Keypad

Directly beneath the display are four white buttons called “soft keys” (Figure 1). These are dynamic keys the function of which changes in response to a menu option displayed directly above each key on the bottom row of the display. Whatever menu option is displayed above one of these keys is the function which that key will perform in that particular menu. These are used throughout the entire menu system for a wide variety of functions. For example, modifications made within a menu are usually not saved unless a SAVE soft key is pressed. EXIT is also another common soft key function.

The four red arrow keys are used to scroll up, down, left, and right to navigate in the menu system, and to select items or change fields on the screen. The arrow keys are also often used to change parameters or increment/decrement values in the menu system.

The key with a circular symbol on it is for adjusting the light/dark contrast on the LCD display. Press and hold the key until the desired contrast is achieved. It is possible to over-adjust the contrast and make the entire display completely blank or completely dark, so be careful to set it to a visible level or it may appear that the unit is not operating.

The function (F) keys serve as shortcuts to commonly used menu screens. Care should be taken in pressing F keys during operation; doing so can sometimes interrupt the sample cycle. The F keys only function from the main menu screen or for entering passwords. The factory default password is F1, F2, F3, F4. Refer to the Met One Operation Manual for more details on the function keys.

Touchscreen BAMs

ADEC also operates some touchscreen BAM-1020s. The software on these BAMs is slightly different; the main menu is shown below in Figure 2. To navigate to specific menus, OPERATE, SETUP, TEST, and ABOUT can be selected.

Figure 2. Touch Screen BAM Front Display Diagram

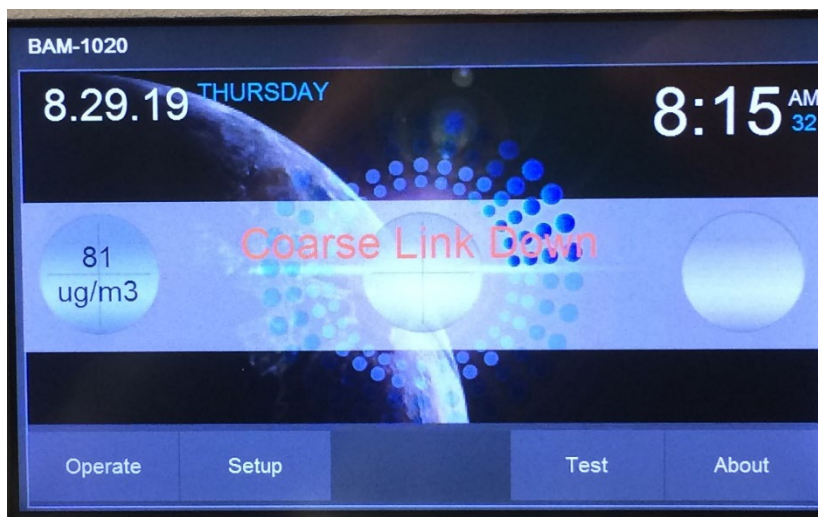

Sampling

1. From the main menu, select OPERATE. The BAM-1020 collects 42 minutes of data each hour. The pump does not run the last ten (10) minutes of each hour and does not start up again until eight (8) minutes after the hour.
2. You can leave the BAM-1020 display at the Main Menu or, on the non-touch screen BAMs, use the soft keys to select NORMAL. NORMAL mode will display most of the important sampling parameters.
3. Leave the sampler in the OPERATE mode so that it does not interfere with the remote communication process.

For the touch screen BAMs, OPERATE can be selected to view the current instrument status and values from the previous hour.

Routine Maintenance and Operational Checks

Perform the following maintenance (Table 1) and operational (Table 2) checks on the BAM-1020 at the intervals specified. The maintenance and operational checks may be performed more frequently but should be performed at least at the prescribed intervals. Document all results and maintenance activities in the BAM-1020 Monthly QC Check Form (Appendix A) or the BAM-1020 Calibration Form (Appendix A) as well as the site logbook.

Table 1. Routine Maintenance Schedule

Routine Maintenance Schedule		
Task	Interval	Reference
Clean shelter interior	1/month	
Clean inlet head & VSCC or SCC	1/month	BX-344 BAM-1020 Inlet Cleaning Kit Manual & BGI VSCC Manual
Replace inlet head O-rings	1/two years	BX-802 PM ₁₀ Inlet Manual
Clean downtube	1/quarter	BX-344 BAM-1020 Inlet Cleaning Kit Manual
Replace VSCC O-rings	1/two years	BGI VSCC Manual
Clean nozzle, vane, and pinch rollers	1/month (or as determined by leak checks)	QA Handbook Vol. II App D; BAM-1020 Manual Rev W, pp. 39-40
Disassemble, clean, & replace O-rings in nozzle assembly	1/two years	BAM-1020 Manual Rev W, pp. 68-69 & Met One Tech Note
Replace tape	as needed (~every 2 months)	BAM-1020 Manual Rev W, pp. 23-24
Rebuild pump	every 12-24 months	SOP, Appendix D
Inspect internal Pisco filter, clean or replace	1/year	QA Handbook Vol. II App D
72-hr zero background filter test	1/year (more frequent recommended e.g., seasonally)	BAM-1020 Manual Rev W, pp. 69-71

Table 2. Operational Checks

Operational Checks			
Check	Interval	Tolerance	Reference
Temperature calibration	At start up, 1/year	$< \pm 2.1^{\circ}\text{C}$	
1-Point Temperature Check	1/month	$< \pm 2.1^{\circ}\text{C}$	
Pressure calibration	At start up, 1/year	$< \pm 10.1 \text{ mmHg}$	
1- Point Pressure Check	1/month	$< \pm 10.1 \text{ mmHg}$	
Flow calibration	At start up, 1/year	$< \pm 2.1\%$ of indicated flow $< \pm 2.1\%$ of design flow (16.7 L/min)	40 CFR Part 50 App L
1-Point Flow Check/Verification	1/month	$< \pm 4.1\%$ of indicated flow $< \pm 5.1\%$ of design flow	
External Leak Check	1/month	$\leq 1.5 \text{ L/min}$	
Clock verification	1/month	+/- 1 minute of NIST-Alaska Standard Time (AST) if not controlled by central data acquisition system	
Data logger verification (compare direct download from instrument to data logger results)	At start up, 1/month	exact agreement (digital)	QA Handbook Vol II Appendix D

Audits

An independent audit is required on the parameters and at the frequencies specified in Table 3.

Table 3. Audit Information

Audits		
Leak Check Audit	1/6 mo - SLAMS/SPM; 1/qtr - PSD	$\leq 1.5 \text{ L/min}$
Temperature Audit	1/6 mo - SLAMS/SPM; 1/qtr - PSD	$< \pm 2.1^{\circ}\text{C}$
Pressure Audit	1/6 mo - SLAMS/SPM; 1/qtr - PSD	$< \pm 10.1 \text{ mmHg}$
Flow Audit		

1/6 mo - SLAMS/SPM;
1/qtr - PSD

< ± 4.1% of audit
standard

< ± 5.1% of design flow
(16.7 L/min)

+/- 1 minute of NIST-
Alaska Standard Time
(AST) if not controlled by
central data acquisition
system

Clock verification

Transfer Standards

All transfer standard equipment must possess up-to-date NIST-traceable certification. Certified temperature and pressure sensors are required for BAM-1020 ambient temperature and pressure calibrations. A certified flow meter or certified fixed orifice device is required for flow calibrations. ADEC currently uses the deltaCal[®] by BGI, Inc. and the Alicat Sci. FP-25BT

volumetric flow calibration devices which meet the certification requirements for Temp, BP, and flow. Calibration devices need to equilibrate to ambient conditions before use. This can take as long as an hour if the device was kept indoors immediately prior to use, shorter if kept in or exposed to outdoor temperatures before deployment. Refer to Appendix B for a list of the required certification intervals for temperature, barometric pressure, and flow standards.

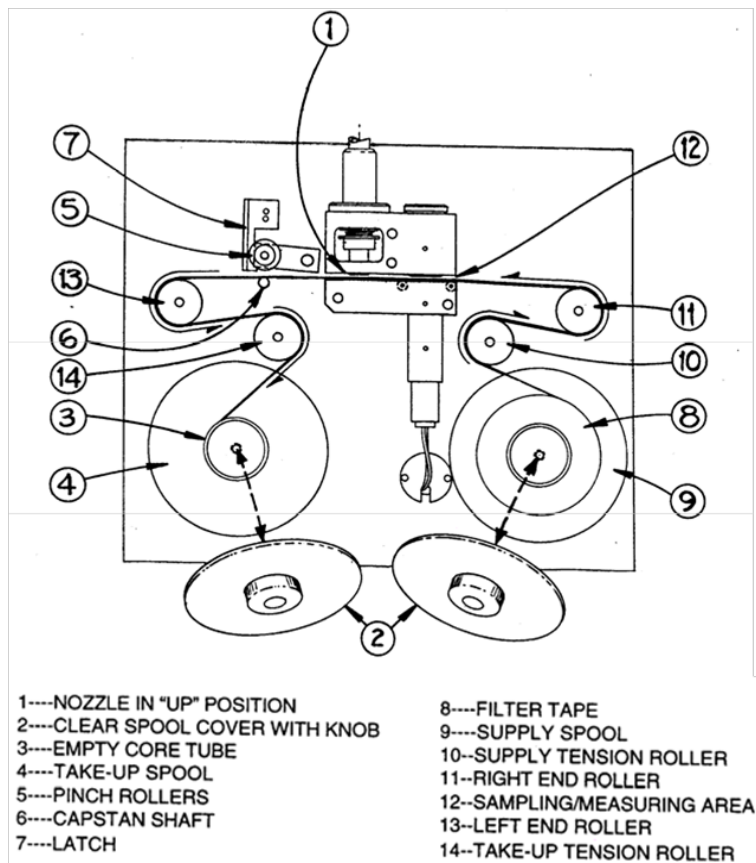

Figure 3. Tape Loading Diagram

Changing the Filter Tape

Refer to Figure 3 for a diagram of the tape path. Begin by lifting the pinch roller (the pin with the black roller located in the upper front of the BAM-1020) and locking the roller into position with the latch (located immediately to the left of the pinch roller). From the main menu, select TEST followed by

PUMP for the non-touch screen BAMs, and LEAK for the touch screen BAMs. Use this screen to move the nozzle up so that it is not putting tension on the tape. Remove both clear spool caps by unscrewing the black knobs. Remove the used filter tape and discard, but save the empty cardboard tape core and place it on the left (take-up) spool. Unroll approximately 2-3 feet of tape and slide the

new roll on to the right (supply) spool of the BAM-1020. Position the supply spool so that as the tape unwinds on the spool, the roll turns counter-clockwise.

The tape will 'S' around the two center rollers by feeding around the left of the supply tension roller located just above and to the left of the supply spool, then around the right side of the right end roller located slightly above and to the right of the tension roller. The tape then slides in the slit located between the source and detector, and between the pinch roller and capstan shaft (the thin metal shaft located just below the pinch roller). 'S' the tape around the left side of the left end roller (roller on the upper left), around the right side of the take-up tension roller (just below and to the right), then secure the end of the filter tape with a small piece of clear tape onto the cardboard tape core that you installed on the bottom left (take-up) spool. Do NOT attach tape to the spool itself. Wrap the filter tape at least once around the cardboard tape core. The left side tape configuration should be a mirror image of the right side.

Lift up on the pinch roller (the latch will automatically unlock) and gently lower the pinch roller until it completely touches the filter tape against the capstan roller. Advance the tape about ten spaces then reverse the tape about five using the procedure outlined on page 21. This helps to position the tape onto the rollers. Always perform a successful self-test after changing the tape; this option is found under TAPE on the main menu for the non-touch screen BAMs, and under TEST and SELF-TEST for the touch screen BAMs. Return the instrument to OPERATE mode prior to leaving the site.

Cleaning the nozzle, vane, pinch rollers, and membrane

See Section 5.6, pp 39-40 of BAM Operation Manual Rev W for detailed instructions. Use a clean cotton swab moistened with isopropyl alcohol to clean the nozzle and vane. Use clean water, NOT alcohol, to clean the pinch rollers and the membrane. Using alcohol on the rubber pinch rollers degrades the rubber and makes them sticky and using alcohol to clean the membrane leaves a film on it.

Leak test

Install a Flow Test Adapter with shut-off petcock in place of the inlet head. Be sure the petcock is fully open before starting the leak test. For the non-touch screen BAMs, use the soft keys to select TEST then PUMP. Choose PUMP ON and allow flow to stabilize. On the touch screen BAMs this screen can be found by selecting TEST and LEAK. Unlike the other BAMs, the touch screen BAMs will not automatically lower the nozzle if the pump is turned on, so ensure that the pump is on and the nozzle is down prior to beginning a leak test. Close the petcock slowly. Let stabilize for about 10-20 seconds and then make a note of the flow rate shown on the BAM-1020 FLOW display. Slowly open the petcock. The leak rate must be ≤ 1.5 L/min and, ideally, less than 1.0 L/min. If it is not, you will need to troubleshoot the cause or source of the leak. Begin by cleaning the nozzle/vane assembly and repeating the leak test procedure. If the leak rate is still > 1.5 L/min, perform advanced leak check procedures as detailed in Section 5.5.2, pp 36-39 of BAM Operation Manual Rev W.

Flow Check (Ambient Temperature, Barometric Pressure, and Volumetric Flow Verification)

Use the following equipment to verify AT, BP, and volumetric flow:

NIST-traceable temperature standard

NIST-traceable pressure standard

NIST-traceable flow standard

Flow check data forms

Ambient Temperature Verification

1. Turn on a NIST-certified temperature/pressure/flow standard and allow it to auto-calibrate under no-flow conditions. Remove the BAM inlet head and place the flow standard on the sampler down-tube.
2. From the main menu, select TEST followed by FLOW (FLOW CHECK for the touch screen BAMs).
3. Allow a few minutes for the reference standard to fully equilibrate to ambient conditions.
4. Compare the BAM-1020 temperature value listed on the row to the right of 'AMBIENT TEMPERATURE' under the column labeled 'BAM' to the ambient temperature (T_a) measured by the NIST-traceable temperature standard.
5. Record the values on the flow check data form. Calculate the difference between the certified transfer standard ambient temperature (T_a) value and the BAM value. A passing check acceptable difference must be $< \pm 2.1^\circ \text{C}$.
6. Remain in this screen for ambient pressure verification or select EXIT.

Barometric Pressure Verification

1. On the non-touch screen BAMs, use the soft keys to choose NEXT. This will move the cursor down to 'BAROMETRIC PRESSURE'. To move the cursor on the touch screen BAMs, simply touch on the text "Barometric Pressure".
2. Compare the BAM-1020 ambient barometric pressure value listed on the row to the right of 'BAROMETRIC PRESSURE' under the column labeled 'BAM' to the barometric pressure measured by the NIST-traceable pressure standard.
3. Record the values on the flow check data form. Calculate the difference between the certified pressure transfer standard value and the BAM value. A passing check acceptable value must be $< \pm 10.1 \text{mm Hg}$.
4. Remain in this screen for flow verification or select EXIT.

Flow Rate Verification:

1. On the non-touch screen BAMs, use the soft keys to choose NEXT. Keep pressing NEXT until the cursor is down on the last flow choice (16.7). **Note: Be sure to use the NEXT soft key and NOT the down arrow key which will permanently change the value where the cursor is flashing.** On the touch screen BAMs, simply tap on the desired flow rate.
2. The pump will automatically turn on. Allow a few minutes for the flow to stabilize, and then compare the BAM-1020 flow value listed under the column labeled ‘BAM’ to the flow rate measured by the NIST-traceable flow standard. Be sure to read and compare **actual flow (Q_a)** rate rather than standard (Q_s) flow rate.
3. Record the values on the flow check data form.
4. Calculate the % difference between the NIST-traceable flow standard value and the BAM value using the equation $[(\text{BAM}Q_a - \text{RefStd}Q_a)/\text{RefStd}Q_a] \times 100$. A passing check acceptable value must be $< \pm 4.1\%$.
5. Calculate the % difference between the NIST-traceable flow standard value and the instrument design value (16.7 L/min) using the equation $[(\text{RefStd}Q_a - 16.7)/16.7] \times 100$. A passing check acceptable value must be $< \pm 5.1\%$.
6. Select EXIT to turn off the pump. On the non-touch screen BAMs, the soft key NEXT can also be used to turn off the pump.

Clock/Timer Verification:

For BAM-1020 samplers that do not have a data acquisition system (DAS) capable of resetting the BAM time, a manual check of the time must be done at a minimum of 1 per month. In most cases, ADEC uses the DRDAS Envista ARM data acquisition software application to control the clocks on the BAM-1020s. For all BAM applications (PM₁₀, PM_{2.5}, & PM_{coarse}), the BAM-1020 time must be compared against a NIST-traceable clock. ADEC currently offsets the time of the BAM-1020s that are controlled by the DRDAS system by approximately + 2 minutes to ensure the time stamp for the hour is recorded by the DRDAS system in the correct time slot.

Calibrate Ambient Temperature (AT), Barometric Pressure (BP), and Volumetric Flow

Use the following equipment to calibrate AT, BP, and volumetric flow:

- NIST-traceable temperature standard
- NIST-traceable pressure standard
- NIST-traceable flow transfer standard
- Calibration data forms

ADEC currently uses the deltaCal[®] calibration device manufactured by BGI, Inc. and the model FP-25BT flow standard from Alicat Sci. that meet the certification requirements for AT, BP, and flow. All transfer standard equipment must possess up-to-date certification. Refer to Appendix B for a list of the required certification intervals for temperature, barometric pressure, and flow standards.

Ambient Temperature, Barometric Pressure, and Volumetric Flow Calibration:

1. Perform an as-found leak check of the monitor (outlined above) prior to calibration.
2. Turn on a NIST-certified temperature/pressure/flow standard and allow it to auto-calibrate under no-flow conditions. Remove the BAM inlet head and place the flow standard on the sampler down-tube.
3. Perform an as-found flow check of the monitor (outlined above) prior to calibration.

To calibrate the non-touch screen BAMs:

4. From the BAM-1020 main menu, use the soft keys to choose TEST. Using the right arrow key, move the cursor over to the word 'FLOW' and use the soft keys to choose SELECT. Before doing the calibration, set the BAM back to the factory default values by using the soft keys to choose DEFAULT. Met One recommends doing this, although it is not mandatory.
5. The cursor will automatically go to the ambient temperature (Ta) parameter. Use the left/right arrow keys to move the cursor to the 'STD' column. With the up/down arrow keys, enter the ambient temperature (in °C) reported by the temperature standard.
6. Use the soft keys to choose ADJUST/SAVE.
7. Use the soft keys to choose NEXT.
8. The cursor will automatically go to the barometric pressure parameter. Use the left/right arrow keys to move the cursor to the 'STD' column. With the up/down arrow keys, enter the barometric pressure reported by the pressure standard.
9. Use the soft keys to choose ADJUST/SAVE.
10. Use the soft keys to choose NEXT.
11. The cursor will automatically go to the first of the three flow parameters (15.5) and the pump will automatically turn on. Use the left/right arrow keys to move the cursor to the 'STD' column. Allow the pump to run until flow rate stabilizes and then use the up/down arrow keys to enter the actual flow reported by the flow standard.
12. Use the soft keys to choose ADJUST/SAVE.
13. Use the soft keys to choose NEXT to advance the cursor to the next flow selection (18.4). Repeat steps 11 and 12.
14. Finally, use the soft keys to choose NEXT. This will advance the cursor to the last flow selection (16.7). Repeat steps 11 and 12.
15. Record all calibration information and data on the ADEC BAM-1020 Calibration Form (Appendix A).

To calibrate the touch screen BAMs:

1. For the touch screen BAMs, select TEST from the main menu, followed by FLOW CHECKS. To test a parameter, touch the blue text for that parameter. At the bottom of the screen, CALIBRATE and DEFAULT will appear. To set the instrument to the factory settings, select DEFAULT. To calibrate the sampler, tap on the value in the 'REFERENCE' column, enter the value from the reference device, and press SAVE. Continue calibrating the remaining parameters. Note that the flow should be

calibrated **after** the ambient temperature and ambient pressure.

Data Acquisition

There are many data acquisition systems (DAS) available that can be used to collect data from the BAM-1020. ADEC now relies on the Envidas for Windows® system to collect data and store it in ADEC's database. ADEC currently uses this system to routinely collect BAM-1020 data from most of its sites but does not typically use this system for short-term monitoring sites. Refer to the Envista/Envidas manuals and SOPs for procedures in using the system.

ADEC primarily uses the direct connect method requiring a computer and Comet software to download data directly from the BAMs for comparison to DAS-collected data, to view BAM configuration data, instrument error codes, and others. Comet Properties and Advanced Port Settings used by ADEC are below in Table 4.

Table 4. Digital Communication Settings

Properties Screen	Advanced Port Settings Screen
Bits per second: 9600	Remove check from "Use FIFO buffers"
Data bits: 8	
Parity: None	
Stop bits: 1	
Flow control: None	

There are many variables that should be considered when choosing these digital communication settings. The most important thing to remember is that both the BAM and the communication software must be set the same. The settings here reflect the BAM factory settings.

To download data directly from the BAM-1020, connect the computer port cable to the upper RS232 connector located at the rear of the BAM-1020. Activate the Comet program and press the computer's Return button three times. An asterisk (*) should appear. If not, depress the small white and red polarity toggle switch located next to the RS232 connector on the back of the BAM-1020. Type the letter 'H' and a menu will appear. To download BAM-1020 data to a laptop or desktop computer, use the 'Capture' function of Comet.

Troubleshooting

Refer to the Met One BAM-1020 Operation Manual for information on error code interpretation as well as a list of symptoms and potential causes.

BAM-1020 Acceptance, Siting, Installation, Configuration, and Calibration

Acceptance

Before beginning acceptance testing of the BAM-1020, become familiar with the theory of operation and hardware of the instrument by thoroughly reading the operating manual. Establish an acceptance test log and an acceptance test report. Record the dates of the individual tests,

problems and contacts with the manufacturer, and any other pertinent information on the acceptance test log.

Check the outside surfaces of the shipping containers for obvious damage before the shipping container is opened. If there is any damage to the shipping container, do not open the container(s), but notify the people who shipped the BAM-1020 and follow their recommended procedures.

Unpack the instrument and check for physical damage. Verify the sampler is complete and includes operational manuals, service manuals, and all options and parts required by the purchase order.

Check for correct power cord phasing; standard wiring configuration has the black wire connected to the brass terminal of the plug, white to the copper terminal, and green to earth ground.

Most of the BAM systems are factory set so there aren't many system tests that can be run for the purposes of acceptance testing. Table 5 contains some general acceptance procedures.

Table 5. Acceptance Testing Procedures

Test	Location	Comments
Power on and warm up	Bench	Verify that BX-596 (or BX-596-1) temperature and pressure readings are realistic; also a good opportunity to check any auxiliary sensor signals
Self-test	Bench	Load tape and run self-test
Leak check	Bench	Must be ≤ 1.5 L/min; preferably < 1.0 L/min
Flow check	Bench	Flow bias $< 4.1\%$, Design condition $< 5.1\%$
Zero test	Field	A field zero test of at least 72 hrs is required by FEM designation. A prior bench zero test may be desirable if the field site is remote.
Collocation with FRM	Field	Comparability testing to a collocated FRM monitor before accepting data as equivalent is required. A minimum of 23 valid and acceptable data pairs must be collected during multiple seasons and the resultant slope of the regression relationship must be $0.90 \leq m \leq 1.10$. See 40 CFR 53.35 (Subpart C).

Siting

The BAM-1020 monitor has specific physical requirements that must be considered prior to installation. The central unit and pump are neither waterproof nor water-resistant and must be protected from moisture. The BAM was designed to operate in a temperature-controlled enclosure between 0 °C and 50 °C with no hourly variation in excess of 2 °C, where there is no condensation within the BAM inlet, and the relative humidity does not exceed 90%. All ADEC BAM-1020 monitors will be installed inside a weather-proof and temperature controlled structure.

Inlet radius clearance: If a BAM-1020 is to be installed at a station with another BAM-1020 or a PM_{2.5} FRM sampler, the inlets of each sampler must be 1-4 meters apart. If installing near a PM₁₀ HiVol sampler, then the distance between the inlets of the BAM-1020 and the HiVol must be no less than two (2) meters. See 40 CFR Part 58 Appendix E for complete probe and monitoring Met One BAM-1020 SOP Rev 1

path siting criteria.

Inlet height: 2 to 7 meters above the ground for micro-scale or middle-scale sites; 2 to 15 meters for all other scales. The height of the inlet should be equal to the height of the FRM filter samplers such as the PM₁₀ inlet head on a PM_{2.5} monitor, or the large round PM₁₀ impactor on a HiVol monitor.

Distance between BAM-1020 and station ceiling: A minimum distance of at least eight (8) inches is required between the top of the BAM-1020 and ceiling. This distance is necessary to safely accommodate the inlet heater kit and insulation.

Heater Kit: The inlet heater kit includes a heater block that slides over the lower end of the inlet tube (inside the station or shelter). The heater will cover approximately four (4) inches in length of the inlet tube. The installed heater should be a minimum of two (2) inches away from any object at either end of the heater, such as the instrument rack or ceiling and no more than two (2) inches away from the inlet assembly on top of the BAM-1020. These measurements suggest that the minimum distance between the BAM-1020 central unit and the ceiling should be no less than eight (8) inches. The inlet heater is used to dry the incoming ambient air to < 35% before it reaches the tape.

Inlet: The straight, vertical inlet tubing (down-tube) of the BAM-1020 limits the placement of the BAM-1020 central unit. The BAM-1020 down-tube is a 1 5/16" OD, 8' long rigid aluminum tube. The lower end of the inlet tube inserts directly into the top of the BAM-1020 housing and the other end points upward through all roofing material and above the roof line. The selected particle size inlet is mounted on the upper end of the inlet tube. If used, the VSCC or SCC fits between the inlet head and the down-tube. The BAM-1020 PM₁₀ head should be installed so that its height is equal to the inlet height of other BAM, FRM filter-based or HiVol samplers. In addition, the sampler inlet must be at least 2 meters above the roof line. Make provision for future removal, maintenance, and re-installation of all equipment.

Specifications: Specifications for siting a BAM-1020 will mirror the Federal EPA PM_{2.5} criteria listed in the Code of Federal Regulations (40 CFR, Part 58 Appendix E). Table 6 below summarizes the siting criteria.

Table 6. Siting Criteria

PM₁₀ and PM_{2.5} Siting Criteria			
Parameter	Tolerance	Reference	
Inlet clearance from obstructions, including other low flow samplers, to sample inlet air flow	≥ 1 meter		
Inlet clearance from sample inlet air flow to HiVol inlet air flow	≥ 2 meters	40 CFR, part 58, Appendix E	
Inlet height above ground	2-7 m micro- and middle-scale sites; 2-15 m all other sites		

Installation

Assemble all components, tools, and supplies (Table 7) and install all cables or signal output wiring following instructions in the operating manual.

Table 7. Tool and Supply List for Installation

	PM ₁₀	PM _{2.5}
Components	BAM-1020 central unit	BAM-1020 central unit
	Vacuum pump (Gast rotary BX-121 or MEDO in-line BX-126)	Vacuum pump (Gast rotary BX-121 or MEDO in-line BX-126)
	Pump tubing and wiring	Pump tubing and wiring
	Inlet down-tube	Inlet down-tube
	PM ₁₀ FRM inlet w/water trap	PM ₁₀ FRM inlet w/water trap
	BX-827 Smart inlet heater kit or 9307 Smart heater upgrade kit	BX-827 Smart inlet heater kit or 9307 Smart heater upgrade kit
	Inlet support brackets or tripod	Inlet support brackets or tripod
Tools and Supplies		PM _{2.5} Very Sharp Cut Cyclone (VSCC) or Sharp Cut Cyclone (SCC)
		BX-596 AT/BP sensor (minimum 1 per coarse pair)
		Hole saw/bits (1 3/8" and 2 1/4")
		Weather proof silicone or roof sealant, and Scotch or masking tape
		2-conductor cable (min. AWG 20 gauge)
		4 lag screws adequate for roof mounting plate
		Tools including drill, screwdrivers, and socket set
		Certified flow standard capable of measuring 16.7 LPM
		Certified temperature and pressure standard

NOTE: Do NOT move the BAM-1020 unless the two hard foam packing rings (referred to as donuts) are placed around the tape transport rollers. Failure to install the donuts prior to moving can cause severe damage to the instrument.

Installing the BAM-1020 Central Unit

The BAM-1020 can be rack mounted or placed on a table, shelf, or other flat surface. ADEC typically places the instrument on an instrument bench. As with all instrument installations, the racks, table, or fixture must be secure and the overall installation must protect both the instrument and personnel.

Because the BAM-1020 connector fitting for the inlet tube is located on top of the central unit, installation of the BAM-1020 does not allow for other instruments to be mounted above it.

However the BAM is installed, vertical space for the inlet tube must be taken into account.

Drilling the Inlet Tube Hole

Applications may vary due to structural and material makeup. Forethought will help alleviate problems and frustration.

After locating a suitable place for the monitor, drill the holes for the inlet tube. Protect instruments from falling debris. The inlet support hardware should include a rooftop mounting plate for stations with a flat roof. The mounting plate has a circular ridge that protrudes beneath the surface and therefore, a 2¼” diameter recess must be made on top of the roof in order to accommodate the ridge.

Inside station ceiling hole: The hole on the inside of the station should be only large enough to accommodate the outside diameter of the BAM inlet tube. A plumb bob can help locate the best position on the ceiling of air monitoring stations. Use a 1 3/8" diameter hole-saw to drill a hole into the ceiling directly above the BAM-1020 inlet spout. STOP drilling when the tip of the guide bit just begins to poke through the top of the roof. The drill bit hole will be used as a guide when drilling down from above and therefore do NOT drill a 1 3/8" hole all the way through the roof.

Outside roof top hole: Relocate to the topside of the roof after drilling the inside ceiling hole from underneath (remember to only drill until the hole saw bit just pokes through the roof top). Using the hole created by the guide drill of the 1 3/8” hole saw bit, drill downward with a 2 ¼” hole-saw until the hole is deep enough to accommodate the roof mounting plate.

Attaching Inlet Support Hardware: Affix the inlet mounting plate to the top of the roof with plenty of weatherproof sealant and four adequate lag bolts. Attach the supplied inlet coupler to the mounting plate. Slide the inlet tube through the coupler, plate, roof, and ceiling. From inside the station, gently insert and seat the bottom end of the inlet tube into the top of the BAM-1020 central unit. Test seal with water. Two (2) additional lag screws, the two (2) supplied inlet brackets and the single (1) supplied hose clamp can be used to help support the inlet tube. The PM inlet(s) can now be attached to the top end of the inlet tube.

Power On and Warm-up: The power switch is located on the back of the unit directly above the power cord. Verify that the unit is plugged into the correct AC voltage and that any electrical accessories are correctly wired before turning the unit on. After power is switched on, the main menu screen should appear after a few seconds. The unit will probably flash an error indicating that there is no filter tape installed.

The BAM-1020 must warm up for **at least one hour** before an operation cycle is started. This allows the electronic components and the beta detector vacuum tube to stabilize after the unit is powered up. The first hourly value should be discarded. This applies any time the unit is powered up after being off for more than a moment. Instrument setups and filter tape installation can be performed during this warm up time.

Connecting the Pump: Connect the pump to the BAM-1020 with the supplied clear vacuum tubing and 2-lead cable. Insert one end of the clear tubing to the only flow inlet connector of the pump and the other end of the tubing to the only tube connector located on the lower rear of the BAM-1020 unit. Push in each end of the tubing all the way, then pull back slightly to ensure a good seal. The tubing should be at least 6 feet long to help reduce any possible flow fluctuations caused by the pump. Attach the leads on one end of the supplied 2-lead cable to the two inside terminals on the pump and the leads on the other end to the terminals on the rear of the unit labeled PUMP CONTROL.

Loading the Filter Tape: Load the tape before accessing other functions. See ‘Changing the Filter Tape’ on page 11 of this SOP, or page 23 of the BAM-1020 Rev W Operator Manual.

Advancing/Reversing the tape: on the non-touch screen BAMs

1. Press the TEST soft key.
2. Using the right arrow key, move the cursor to TAPE and press the SELECT soft key
3. With the up or down arrow keys, adjust the number on the FEED: line until '10 MORE WINDOWS' is displayed
4. Press the FWD soft key
5. Wait until the X: display reads '10 WINDOWS'
6. With the up or down arrow keys, adjust the number on the FEED: line until '5 MORE WINDOWS' is displayed
7. Press the BKWD soft key.
8. Visually check tape for binding, tears, or other obvious problems. Wherever the tape comes in contact with the rollers the **entire width** of the tape should be on the roller with a little bit of the roller's edge showing.
9. Press the EXIT soft key. The BAM-1020 tape is now loaded and adjusted.
10. Press the TAPE soft key then choose SELF TEST. The BAM-1020 will test the tape carriage operation and will turn on the pump to verify flow through the inlet and tape. A successful Self-Test is indicated by ‘SELF TEST PASSED’ in the STATUS line. Return the instrument to Operate mode.

Advancing/Reversing the tape: on the touch screen BAMs

To advance the tape on the touch screen BAMs, select OPERATE from the main menu followed by LOAD TAPE. On this screen, there are forward and backward buttons to move the tape.

Connect the Ambient Temperature (AT) and Barometric Pressure (BP) Sensor

All BAM-1020 monitors deployed by ADEC will be configured for actual/volumetric flow control. This requires a dual Ambient Temperature and Pressure sensor (BX-596). The AT/BP sensor must be calibrated prior to calibrating the flow.

Mount the sensor on the down-tube using the bracket and V-bolt. Run the sensor cable over the side of the platform and through the wall of the shelter. There should be an opening cut in the side wall towards the rear of the BAM-1020 that is large enough to accept the cable.

Figure 4 shows the connections between the sensor and the terminal block on the back panel of the BAM-1020. AT is connected to channel 6 and the other channel assignments reflect ADEC's current standardization scheme (refer to Configuration/Channels section below).

Figure 4. Electrical Connections

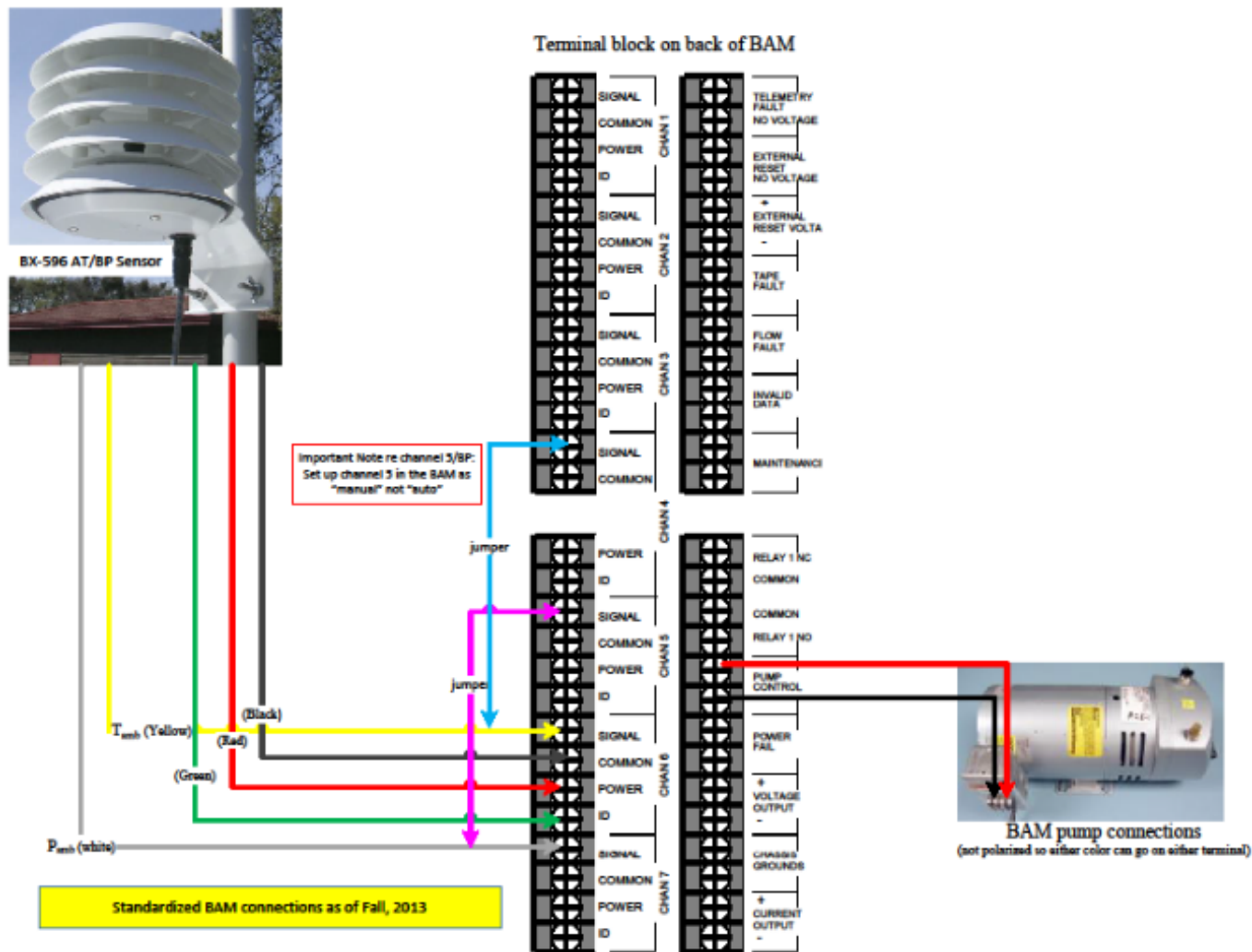

Configuring Sample, Calibrate, Interface, Sensors, and Heater

The BAM-1020 uses a comprehensive system of setup menus which contain all of the settings and parameters needed to perform the measurement and operation of the unit. Most of these settings are set at factory default values which will be correct for most applications. Some settings may be altered by the operator to suit the specific needs of the monitoring program. Some of the settings in the SETUP menus are unit-specific calibration constants which must not be changed, or the accuracy and proper operation of the unit may be affected. Once set, most of the values in the SETUP menus will not need to be changed by the site operator. The SETUP values will not be lost if the unit is unplugged or powered down. This SOP addresses only those parameters which are normally accessed by the operator.

Sample

Select SETUP then SAMPLE from the main menu. Once in the SETUP SAMPLE menu, use the soft keys to choose the desired parameter. Refer to Table 8 below for sample configuration settings for PM₁₀ and PM_{2.5} in a coarse pair. Select SAVE and EXIT when finished.

Table 8. Sample Parameters

Parameter	Setting	
RS232	9600 8N1	<p>*Warning: This setting will affect how long the memory will last before getting full! There are 4369 records available in the BAM memory. The default MET SAMPLE period of 60 minutes (1 record per hour) will result in 182 days worth of memory capacity, but a 1-minute average period would fill up these memory records in only 3 days. When the memory gets full the unit over-writes the oldest data. Leave the MET SAMPLE period set at the default value of 60 minutes unless a faster average is required for a particular met sensor application.</p>
STATION #	to be determined by data steward	
RANGE	1.000 mg	
CONC UNITS	ug/m3	
BAM SAMPLE	42 min	
MET SAMPLE	60 min*	
OFFSET	-0.015 mg	
COUNT TIME	8 min	

Note that data can be incorrectly transposed over previous records under certain conditions. Records can contain PM values that are associated with the wrong date if the battery runs low or out, when BAMs are moved from one site to another without memory cleared, or when interruptions in continuous monitoring occur and monitors sit idle for long periods of time.

Calibration

In the CALIBRATE screen, located under SETUP from the main menu, the factory-determined BAM-1020 calibration parameters can be found. These values are unit-specific. Most of these settings should never be changed without specific instruction from Met One Instruments. If these values are erased they can be found on the calibration certificate that comes with each BAM-

1020 and re-entered into the monitor. Table 9 lists only those parameters which the operator would normally change.

Table 9. Other Settings

Interface

From the main menu, select SETUP then INTERFACE. There are two different configurations for the BAM-1020 analog output: the 'Standard' mode and the 'Early' cycle mode. ADEC uses the Standard mode. Use the soft keys to choose STANDARD, then SAVE and EXIT.

Parameter	Setting
CONC TYPE	ACTUAL
FLOW TYPE	ACTUAL
ABS	only changed when foil replaced
BKGD	determined by zero-air test
HEATER	AUTO

Sensors (Channels)

ADEC has standardized the BAM-1020 channel assignments for its BAM installations but these channel assignments may be changed as needed. Table 10 contains the standard channel assignments and configuration settings.

To set up the channels for the non-touch screen BAMs, use the soft keys to choose SETUP then SENSORS. Use the soft keys to select a channel and to change settings if necessary. Be sure to choose SAVE after configuring each channel. Choose EXIT when done.

For the touch screen BAMs, the channels can be setup by selecting SETTINGS and then MET INPUTS from the main menu.

Table 10. ADEC BAM Channel Assignments & Configuration Settings

Channel #	Sensor ID	Channel ID	Name	Units	Prec	FS Volts	Mult	Offset	Vector/ Scalar	Inv slope
1	255	255	WS (wind speed)	mph	1	1.000	100.0	0.0	S	N
2	255	255	WD (wind direction)	Deg	0	1.000	361	-3	S	N
3	1	254	Tsh (shelter temperature)	°C	2	2.500	95.0	-40.0	S	N
4	255	255	RH (relative humidity)	%	0	0.500	32	-26	S	N
5*	255	255	BP (barometric pressure)	mmHg	0	2.500	300	525	S	N
6	35	254	AT (ambient temperature)	°C	1	2.500	95.0	-40.0	S	N

Settings shown are used for 596 sensor; reference Met One manual for 596-1 sensor settings.

*Channel 5 should be set to Manual, all other channels should be set to Auto ID.

Channel 7 signal is not stored.

Table 11. Heater Settings

Heater

From the main menu, select SETUP then HEATER. Table 11 lists the settings which ADEC uses.

Parameter	Setting
RH CONTROL	YES
RH SETPOINT	35%
Datalog RH	YES (channel 4)
DELTA-T CONTROL	NO
DELTA-T SETPOINT	not used
DATALOG DELTA-T	NO

Coarse pair setup

Refer to the addendum (BX-COARSE-9800 Rev B) to the Operation Manual for procedures to set up a PM₁₀ and PM_{2.5} BAM as a coarse pair.

Additional Checks

Check that the meteorological sensors are operating by using the soft keys to choose INST on the Operate Mode screen. The various sensor outputs should be displayed. Check that the internal data logging of the BAM-1020 is operating properly by connecting a computer to the RS232 port at the rear of the instrument or via ADEC’s automated data acquisition system.

Data Validation

Data validation is the process by which field and QA/QC personnel review and approve the sample data collected to ensure that the data meet all of the required collection criteria for the method. The Data Validation Template in Appendix C lists these criteria.

In addition, ADEC has the following data invalidation and qualification conventions:

1. The first hourly concentration following a power failure may be invalidated and given an AQS null code of AV. Met One recommends this in their operations manual for the BAM-1020.
2. PM_{10L} values less than -10 and PM_{10S} values less than -5 shall be invalidated and given an AQS null code of DA.
3. PM_{2.5} values less than -10 shall be invalidated and given an AQS null code of DA.
4. What about PM_{2.5}>>PM₁₀ (at least 5 units greater)???
5. Data points for which the Relative Humidity is greater than 35% may have an AQS Qualifier code added after consultation with the Quality Assurance Officer.

Appendix A: Forms

ADEC - AIR QUALITY
QC REPORT ~ BAM SAMPLER - PM2.5/PM10

Date:

Time:

SITE:

Last Audit:

Sampler Info	Sampler Type: _____ M/N: _____ Serial #: _____	Recheck of Results after Corrections	Operator: _____ Criteria & Information
Clock Time & Date (NIST+2min.)	Traceable Std: _____ Sampler: _____ Difference: 0:00:00	Corrected Y/N <input type="checkbox"/> Y <input checked="" type="checkbox"/> N	± 1 min of NIST Time
Vacuum Leak Check	Flow Reading: _____ lpm	_____ lpm	≤ 1.5 lpm
Ambient Temperature	Traceable Std: _____ °C Sampler: _____ °C Difference: 0.0 °C	_____ °C _____ °C 0.0 °C	± 2.1 °C
Barometric Pressure	Traceable Std: _____ mm Hg Sampler: _____ mm Hg Difference: 0.0 mm Hg	_____ mm Hg _____ mm Hg 0.0 mm Hg	± 10.1 mmHg
Traceable Sampler Flow Check	Traceable Std: _____ lpm Sampler: 16.7 lpm	_____ lpm _____ lpm	QC Transfer Standard _____ Cert. Date _____ Ref Device #/s: _____ Exp. Date _____
% Difference from Q act	_____ %	_____ %	Accuracy % Δ ≤ ± 4.1%
% Difference from Design	_____ %	_____ %	Design Condition % Δ ≤ ± 5.1%

Maintenance Items

Date: _____

- | | |
|---|--|
| <input type="checkbox"/> 1: Inspect/clean: PM10 Inlet & seals | <input type="checkbox"/> 5: Remove Filter Tape - Clean Compartment |
| <input type="checkbox"/> 2: Inspect/clean: Nozzle & Vane | <input type="checkbox"/> 6: Installed new tape roll |
| <input type="checkbox"/> 3: Inspect/clean: Capstan & Pinch roller | <input type="checkbox"/> 7: Inspect/clean: AC Filter & heat exchanger fins |
| <input type="checkbox"/> 4: Inspect Nozzle & Tape for burrs & holes | <input type="checkbox"/> 8: Tape Self Test Passed |

NOTES:

.....

.....

.....

.....

**ALASKA DEPARTMENT OF ENVIRONMENTAL CONSERVATION
DIVISION OF AIR QUALITY - AIR MONITORING QUALITY ASSURANCE
PM-2.5/PM-10 BAM CALIBRATION**

Network Agency: ADEC

Site Name:

GPS:

Elevation:

Location:

Date:

Time: AST

Operator:

Observer:

SAMPLER INFORMATION

Sampler:	<input type="text"/>	Mfg.: Met One	M/N: BAM 1020	S/N: <input type="text"/>
----------	----------------------	---------------	---------------	---------------------------

Performed by:

REFERENCE DEVICE INFORMATION

Flow Audit Device	Mfg. <input type="text"/>	M/N: <input type="text"/>	S/N: <input type="text"/>
cert. by: <input type="text"/>	cert date: <input type="text"/>	exp. date: <input type="text"/>	T_a units in °C P_a units in mb and mm Hg Flow units in L/min

CALIBRATION RESULTS

	Target BAM	As found		As left	
		REF Device	BAM	REF Device	BAM
Ambient Temperature (°C)					
Barometric Pressure (mm Hg)					
	15.0 L/min				
	18.4 L/min				
	16.7 L/min				
Leak					

NIST Time (AST)		Sampler Time (AST)		NIST time differential	
Date	hour:minute:second	Date	hour:minute:second	Days	hour:minute:second
				0	0:00:00

Comments :

Appendix B: Standards Traceability

Table 5. Standards Traceability

Standards Traceability			
Standard type	Interval	Tolerance	Reference
Temperature Standard	Certification to NIST 1/year	$\pm 0.1^\circ \text{C}$ resolution, $\pm 0.5^\circ \text{C}$ accuracy	EPA QA Handbook Vol. II Sect 12.4
Pressure Standard	Certification to NIST 1/year	$\pm 1 \text{ mm Hg}$ resolution, $\pm 5 \text{ mm Hg}$ accuracy	
Flow Transfer Standard	multipoint certification against NIST-traceable standard volume meter 1/year	$\pm 2 \%$ of standard	40 CFR 50 App L sect 9.2.2
Time Standard	Checked against NIST Alaska Standard Time prior to each use	$< \pm 10$ seconds	

Appendix C: Data Validation Template

MET ONE BETA ATTENUATION MONITOR (BAM) 1020 PM₁₀ & PM_{2.5}

DATA VALIDATION TEMPLATE

The Met One BAM 1020 PM₁₀ & PM_{2.5} data validation template provides a "look-up" table of all the significant quality control criteria important for the proper implementation of the method and is a tool for validating PM₁₀ & PM_{2.5} data. The template is divided into the following three classes/tables: critical criteria, operational evaluations, and systematic issues.

I. CRITICAL CRITERIA TABLE

Criteria deemed critical to maintaining the integrity of a sample or group of samples reside in the **Critical Criteria Table**. Observations that do not meet each and every criterion on the Critical Table should be invalidated unless there are compelling reasons and justifications for not doing so. Basically, the samples for which one or more of these criteria are not met are invalid unless proven otherwise. The cause for not operating in the acceptable range for each violated criteria must be investigated and minimized to reduce the likelihood that additional samples will be invalidated.

II. OPERATIONAL EVALUATIONS TABLE

Criteria important for maintaining and evaluating the quality of the data collection system reside in the **Operational Evaluations Table**. Violation of a criterion or a number of criteria may be cause for invalidation. The decision should consider other quality control information that may or may not indicate the data are acceptable for the parameter being controlled. Therefore, the sample or group of samples for which one or more of these criteria are not met is suspect unless other quality control information demonstrates otherwise. The reason for not meeting the criteria **MUST** be investigated, mitigated and/or justified.

III. SYSTEMATIC ISSUES TABLE

Criteria important for the correct interpretation of the data but do not usually impact the validity of a sample or group of samples reside in the **Systematic Issues Table**. For example, data quality objectives are included in this table. If data quality objectives are not met, this does not invalidate any samples but it may impact the error rate associated with the attainment/non-attainment decision.

PM₁₀ & PM_{2.5} MET ONE BAM 1020 CRITICAL & OPERATIONAL EVALUATIONS

S - single instrument value, G1 group of values from 1 instrument, G group of values from multiple instruments in a network

Parameter	Criteria	Acceptance Range	Frequency	Samples Impacted ^a	40 CFR Reference	EPA QA Guidance/Manual	ADEC
Station Design/Siting Criteria							
PM ₁₀ & PM _{2.5}	Sample inlet clearance from obstructions to sample inlet air flow	Inlet ≥ 1 meter from obstructions, including other low volume samplers (16.7 lpm)	All Samples	G1	Part 58 Appendix E	EPA QA Handbook Vol II sec 6 & 7	
		Inlet ≥ 2 meters from high volume samplers (1.13 m ³ /minute)					
	Sample inlet height above ground	2 meters < inlet height < 15 meters					
	Sample inlet distance from traffic corridors	Depends upon representative scale of siting, see references (i.e., micro, middle, neighborhood, urban, regional)					
Range							
PM ₁₀ & PM _{2.5}	Sample pump time	42 minutes	All	S, G1			BAM 1020-9800 Manual Rev. W
Calibration Verification (Quality Control Checks)							
PM ₁₀ & PM _{2.5}	One-point flow rate verification (Critical Criterion)	< ± 4.1% of transfer std < ± 5.1% of design value	every 30 days separated by 14 days	G1	Part 58 Appendix A	EPA QA Handbook Vol II App D	BAM 1020-9800 Manual Rev. W
	Temperature verification	< ± 2.1° C	every 30 days	G1			
	Pressure verification	< ± 10.1 mmHg	every 30 days	G1			
	Leak Check (Critical Criterion)	≤ 1.5 L/min	every 30 days and upon inlet or cyclone maintenance	G1			
	72-hour background (zero filter) test	Hourly Std Dev < 2.4 ug	Minimum every 12 months, preferred seasonally	G1			
	BAM data download	Download BAM data and error logs	1/month and/or at error indication	G1			ADEC BAM 1020 SOP
Maintenance							
PM ₁₀ & PM _{2.5}	Data Logger	Download data from internal data logger	1/month	G1			
	Nozzle & vane	Clean w/ isopropyl alcohol	1/month or more frequently as determined by leak check	G1			BAM 1020-9800 Manual Rev. W
	Capstan shaft and pinch roller tires	Clean w/ water	1/month	G1			

PM₁₀ & PM_{2.5} MET ONE BAM 1020 CRITICAL & OPERATIONAL EVALUATIONS

S - single instrument value, G1 group of values from 1 instrument, G group of values from multiple instruments in a network

Parameter	Criteria	Acceptance Range	Frequency	Samples Impacted ^a	40 CFR Reference	EPA QA Guidance/Manual	ADEC
	PM inlet down-tube	Clean	every 90 days	G1		QA Handbook Vol II App D	
PM ₁₀	PM10 inlet	Clean or inspect	every 30 days	G1			
PM _{2.5}	PM2.5 inlet	Clean	every 30 days	G1			
PM ₁₀ & PM _{2.5}	Pump muffler	Replace or clean	1/6 months	G1			
	Internal debris filter	Clean and replace	1/12 months	G1			
	Membrane span foil	Clean and replace	1/12 months	G1			
	β Detector count rate test	Perform	1/12 months	G1			
	β Detector dark count test	Perform	1/12 months	G1			
	Test analog output	Perform (if used with DAS)	1/12 months	G1			
	Internal Pisco filter	Check, replace as needed	1/12 months	G1			
	Vacuum pump	Rebuild	12 – 24 months	G1			
Standards Traceability							
PM ₁₀ & PM _{2.5}	Flow Transfer Standard recertification	Multipoint recertification against NIST-traceable volume meter (< ± 2%)	1/12 months	G1, G		QA Handbook Vol II Sec 12	AM&QA QAPP
	Temperature Standard recertification	Multipoint recertification ± 0.1°C measurement resolution, ± 0.5°C accuracy, NIST-traceable certification over expected range of use					
	Pressure Standard recertification	± 1 mmHg resolution, ± 5 mmHg accuracy					
Assessments							
PM ₁₀ & PM _{2.5}	Bias - 1-point flow, temperature, pressure performance audit		SLAMS/SPM 1/6 months PSD Each monitor every quarter	G1, G	Part 58 Appendix A	QA Handbook Vol II App D	AM&QA QAPP
	1- Point flow rate (Bias)	BAM flow < ± 4.1 % of Audit Standard					
	1- Point flow rate (Design)	Audit Std flow < ± 5.1 % of 16.7 L/min (design flow)					
	Temperature audit	< ± 2.1° C from audit standard					
	Pressure audit	< ± 10.1 mmHg from audit standard					

PM₁₀ & PM_{2.5} MET ONE BAM 1020 CRITICAL & OPERATIONAL EVALUATIONS

S - single instrument value, G1 group of values from 1 instrument, G group of values from multiple instruments in a network

Parameter	Criteria	Acceptance Range	Frequency	Samples Impacted ^a	40 CFR Reference	EPA QA Guidance/Manual	ADEC
PM ₁₀ & PM _{2.5}	Precision						
	Collocated continuous monitors	CV ≤ 10.1% for values ≥ 3.0 µg/m ³	quarterly	G1			
		CV ≤ 10.1% for values ≥ 3.0 µg/m ³	annual	G1			

CV= coefficient of variation

PM₁₀ & PM_{2.5} MET ONE BAM 1020 SYSTEMATIC ISSUES

S - single instrument hourly value, G group of hourly values from 1 instrument

Parameter	Criteria	Acceptable Range	Frequency	Samples Impacted ^a	40 CFR Reference	EPA QA Guidance/Manual	DEC
Data Completeness							
PM ₁₀ , PM _{2.5}		≥ 75% NCore, SLAMS, SPM	quarterly	G1			AM&QA QAPP
		≥ 80% PSD	quarterly, for four (4) consecutive qtrs				
Calibration Verification (Quality Control Checks)							
PM ₁₀ , PM _{2.5}	Clock/timer verification	≤ ± 1 minute	monthly	G1			
Maintenance							
PM ₁₀ , PM _{2.5}	Run Self-Test function	Self-Test passes	quarterly and after QC checks, audits, tape change				BAM 1020-9800 Manual Rev. W
Assessments							
PM ₁₀ , PM _{2.5}	Bias/Accuracy	Technical Systems Audit (NCore, SLAMS, SPM)	1/3 years			QA Handbook Vol II	
		Technical Systems Audit (PSD Quality Monitoring Networks)	1/year and within 1 month of project start-up	all			
Data Review, Verification, Validation							
PM ₁₀ , PM _{2.5}	Data review	Review all data	quarterly	all			
		Check all sites report data	quarterly	all			
	Data validation	Check for appropriate validation flags	quarterly	all			

Appendix D: Pump Information (Gast rotary type)

Gast Series 23 Pump Operation & Maintenance Manual

PART NO. 70 - 290 G375PL (REV-G)

23 SERIES OIL-LESS VACUUM PUMPS & COMPRESSORS

OPERATION & MAINTENANCE MANUAL



Model #0523-101 Shown



Model #1023-V103 Shown



Model #1023-101Q Shown

Thank you for purchasing this Gast product. It is manufactured to the highest standards using quality materials. Please follow all recommended maintenance, operational and safety instructions and you will receive years of trouble free service.

IMPORTANT: PLEASE READ THIS MANUAL AND SAVE FOR FUTURE REFERENCE.

General information

- **Clearances:** Top: .002"
Ends: .0015" - .005"
- **Vane Life:** 5,000-15,000 hours depending upon application

- **Model numbers ending in "X"** have automatic thermal protectors which protect the motor by shutting the motor off if it overheats. The motor will automatically restart once the motor has cooled.

Product Use Criteria:

- Pump only clean, dry air.
- Operate at 32°F - 104°F (0°C - 40°C).
- Protect unit from dirt & moisture.
- Do not pump flammable or explosive gases or use in an atmosphere that contains such gases.
- Protect all surrounding items from exhaust air. This exhaust air can become very hot.
- Corrosive gases and particulate material will damage unit. Water vapor, oil-based contaminants or other liquids must be filtered out.
- Consult your Gast Distributor before using at high altitudes.

- Oil-Less rotary-vanes require NO lubrication.
- Sealed bearings are grease packed.
- Use of petroleum or hydrocarbon products will reduce carbon-vane service life.



ISO 9001 & 14001 CERTIFIED

www.gastmfg.com

©Registered Trademark/™Trademark of Gast Manufacturing Inc., Copyright ©2001 Gast Manufacturing Inc. All Rights Reserved.

Met One BAM-1020 SOP Rev 1

May 2020

39

Your safety and the safety of others is extremely important.

We have provided many important safety messages in this manual and on your product. Always read and obey all safety messages.



This is the safety alert symbol. This symbol alerts you to hazards that can kill or hurt you and others. The safety alert symbol and the words "DANGER" and "WARNING" will precede all safety messages. These words mean:

DANGER

You **will** be killed or seriously injured if you don't follow instructions.

WARNING

You **can** be killed or seriously injured if you don't follow instructions.

All safety messages will identify the hazard, tell you how to reduce the chance of injury, and tell you what can happen if the safety instructions are not followed.

INSTALLATION

WARNING



Electrical Shock Hazard

Disconnect electrical power at the circuit breaker or fuse box before installing this product.

Install this product where it will not come into contact with water or other liquids.

Install this product where it will be weather protected.

Electrically ground this product.

Failure to follow these instructions can result in death, fire or electrical shock.

Correct installation is your responsibility. Make sure you have the proper installation conditions and that installation clearances do not block air flow.

Blocking air flow over the product in any way can cause the product to overheat.

Mounting

This product can be installed in any orientation.

Mounting the product to a stable, rigid operating surface and using shock mounts will reduce noise and vibration.

Plumbing

Remove plugs from the IN and OUT ports. Connect with pipe and fittings that are the same size or larger than the product's threaded ports.

Accessories

The product's intake and exhaust filters will provide adequate filtration in most applications. Consult your Gast representative for additional filter recommendations. Install relief valves and gauges at inlet or outlet, or both, to monitor performance. Check valves are required to prevent back streaming through the pump.

Motor Control

It is your responsibility to contact a qualified electrician and assure that the electrical installation is adequate and in conformance with all national and local codes and ordinances.

Determine the correct overload setting required to protect the motor (see motor starter manufacturer's recommendations). Select fuses, motor protective switches or thermal protective switches to provide protection. Fuses act as short circuit protection for the motor, not as protection against overload. Incoming line fuses help to withstand the motor's starting current. Motor starters with thermal magnetic overload or circuit breakers protect motor from overload or reduced voltage conditions.

The wiring diagram attached to the product provides required electrical information. Check that power source is correct to properly operate the dual-voltage motor.

OPERATION

WARNING

Injury Hazard

Product surfaces become very hot during operation, allow product surfaces to cool before handling.

Air stream from product may contain solid or liquid material that can result in eye or skin damage, wear proper eye protection.

Failure to follow these instructions can result in burns, eye injury or other serious injury.

It is your responsibility to operate this product at recommended pressures or vacuum duties and room ambient temperatures.

Model numbers ending in "X" have automatic thermal protectors which protect the motor by shutting the motor off if it overheats. The motor will automatically restart once the motor has cooled.

Start Up

If motor fails to start or slows down significantly under load, shut off and disconnect from power supply. Check that the voltage is correct for motor and that motor is turning in the proper direction. Vane life will be drastically reduced if motor is not operating properly. Vanes can break or be damaged if motor/pump runs in the wrong direction.

MAINTENANCE

! WARNING



Electrical Shock Hazard

Disconnect electrical power supply cord before performing maintenance on this product.

If product is hard wired into system, disconnect electrical power at the circuit breaker or fuse box before performing maintenance on this product.

Failure to follow these instructions can result in death, fire or electrical shock.

! WARNING

Injury Hazard

Product surfaces become very hot during operation, allow product surfaces to cool before handling.

Air stream from product may contain solid or liquid material that can result in eye or skin damage, wear proper eye protection.

Flush this product in a well ventilated area.

Failure to follow these instructions can result in burns, eye injury or other serious injury.

- It is your responsibility to:**
- Regularly inspect and make necessary repairs to product in order to maintain proper operation.
 - Make sure that pressure and vacuum is released from product before starting maintenance.

Check intake and exhaust filters after first 500 hours of operation. Clean filters and determine how frequently filters should be checked during future operation. This one procedure will help to assure the product's performance and service life.

- General Maintenance**
1. Remove end cap and filters. Inspect filters for rips, tears, cuts, brittleness and excessive foreign material.
 2. Clean filters if in good condition with compressed air. Re-inspect for wear conditions. Set filters aside.
 3. Check filter/muffler (#11) for compacted debris. If debris is present, replace filter/muffler.
 4. Check condition of O-ring. It should be soft and flexible. Replace if it is not.
 5. Remove and inspect muffler box. Clean box. Set box aside. (Not all models have a muffler box.)
 6. Check gasket for cracks or tears. Install new gasket if any cracks or tears appear. Replace gasket.
 7. Replace muffler box.
 8. Reinstall filters or install new filters if required. Reinstall end cap.

Flushing

Flushing this product to remove excessive dirt, foreign particles, moisture or oil that occurs in the operating environment will help to maintain proper vane performance. There are 2 options for this operation. If Option 1 does not remedy your problem, go on to Option 2.

Use only Gast AH255B Flushing Solvent or other non-petroleum based flushing solvent. Do Not use kerosene or ANY other combustible solvents to flush product.

- Option 1**
- You will need 2 pipe nipples at least 4 inches long with 1/4" NPT for 0323 and 0523 products, or 3/8" NPT on one end for 0823 and 1023 products. No nipples are needed if the unit does not have a muffler box.
1. Remove filter and muffler cap (#9).
 2. Remove 5 bolts. Use a small hammer to tap on muffler box to remove it. Attach pipe nipples where muffler caps were removed.
 3. Start product and add flushing solvent to the inlet port. If using liquid solvent, pour several tablespoons directly into the inlet port. If using Gast AH255B, spray solvent for 5-10 seconds into inlet port. Place towel over exhaust port to clean up solvent.
 4. Plug inlet port for 20-30 seconds. Listen for changes in the sound of the pump. If pump sounds smooth, go to next step. If pump does not sound like it is running smoothly, installing a Service Kit will be required (See Service).
 5. Release vacuum.
 6. Repeat steps 3-5 three or four times.

If Option 1 is not successful, remove the end plate and examine.

- Option 2**
1. Remove six end plate bolts. (See exploded view.)
 2. Use a small hammer to carefully tap on end plate to remove. Do not use a screwdriver to pry off.
 3. Check that vanes are moving freely in and out of vane slots. Replace vanes if more than 50% of the vane extends past the vane slot.
 4. Remove vanes and clean both sides with fine emery cloth. Clean end-plate with fine emery cloth.
 5. Flush vanes with AH255B solvent and remove all solvent from vanes.
 6. Flush body, rotor and end plate with AH255B solvent, then remove all solvent from each part.
 7. Check body, rotor and end plate for scoring. If each part is clean and shows no signs of scoring, re-install parts. If scoring appears, send unit to factory or replace with new part(s).

Check that all external accessories such as relief valves and gauges are attached to cover and are not damaged before re-operating product.

SHUTDOWN PROCEDURES

It is your responsibility to follow proper shutdown procedures to prevent product damage. NEVER ADD OIL TO THIS OIL-LESS PUMP.

1. Disconnect plumbing.
2. Operate product for at least five minutes without plumbing.
3. Run at maximum vacuum for 10-15 minutes.
4. Repeat step 2.
5. Disconnect power supply.
6. Plug open ports to prevent dirt or other contaminants from entering product.

SERVICE KIT INSTALLATION

WARNING



Electrical Shock Hazard

Disconnect electrical power supply cord before installing Service Kit.

If product is hard wired into system, disconnect electrical power at the circuit breaker or fuse box before installing Service Kit.

Vent all air lines to release pressure or vacuum.

Failure to follow these instructions can result in death, fire or electrical shock.

Gast will NOT guarantee field-rebuilt product performance. For performance guarantee, the product must be returned to a Gast-authorized facility.

Service Kit contents vary. Most contain vanes, gaskets and filter parts.

1. Remove filter/muffler parts from front of muffler box.
2. Remove the 5 muffler box bolts.
3. Use a small hammer to tap on box to remove. Do not use a screwdriver.
4. Remove the 6 end plate bolts.
5. Remove end plate. Check direction of bevel edges of vanes then remove vanes.
6. Clean body and rotor slots.
7. Check end plate, rotor and body for scoring. Severe scoring or worn bearings will require service at a Gast-authorized facility.

DO NOT remove rotor or motor bolts.

8. Insert vanes, checking that the bevel edges are in the correct direction.

9. Replace end plate. Torque bolts to 90-120 in. lb.
10. Check gasket for damage.
11. Reinstall muffler box. Torque bolts to 90-120 in. lb.

Check that all external accessories such as relief valves and gauges are attached and are not damaged before re-operating product.

EXPLODED PRODUCT VIEW, PARTS & ORDERING INFORMATION

REF	DESCRIPTION	QTY	0323-101	0323-101Q	0523-101	0523-101Q	0523-V103
1	BODY	1	AK503	AK503	AK505	AK505	AK505
2*	VANE	4	AH850A	AH850A	AH850A	AH850A	AH805A
3	SHROUD	1	AK502	AK502	AK502	AK502	AK502
4	END PLATE	1	AK516A	AK501	AK516A	AK501	AK516A
5*	GASKET	1		AK521		AK521	
6	MUFFLER BOX	1		AK519		AK519	
7*	O-RING	2		AK473		AK473	
8*	FELT	2		AK524		AK524	
9	END CAP	2		AK510		AK510	
10	END CAP ASSEMBLY	2		AK526		AK526	
11	FILTER / MUFFLER	1		AK940A		AK940A	
12	FOOT SUPPORT	1		AC136		AC136	
13	ELBOW ***	2					AD997
14	MUFFLER ASSEMBLY	1					V425L
15	JAR	2					AA125A
16	COVER	1					AV427
17	FELT FILTER	4					B344A
18	SUPPORT	1					B345A
19	COVER GASKET	2					B82A
20	FILTER ASSEMBLY	1					V400G
21	COVER	1					AV402CPC
22	FILTER ASSEMBLY	1					B343B
23	SCREEN CAP	1					AJ571
24	FELT SUPPORT	1					B347
	SERVICE KIT	1	K478A	K478	K478A	K478	**

* Denotes parts included in the Service Kit. Parts listed are for stock models.
 ** No Service Kit available, order parts separately. *** Not shown.
 For specific OEM models, please consult the factory.
 When corresponding or ordering parts, please give complete model and serial numbers.

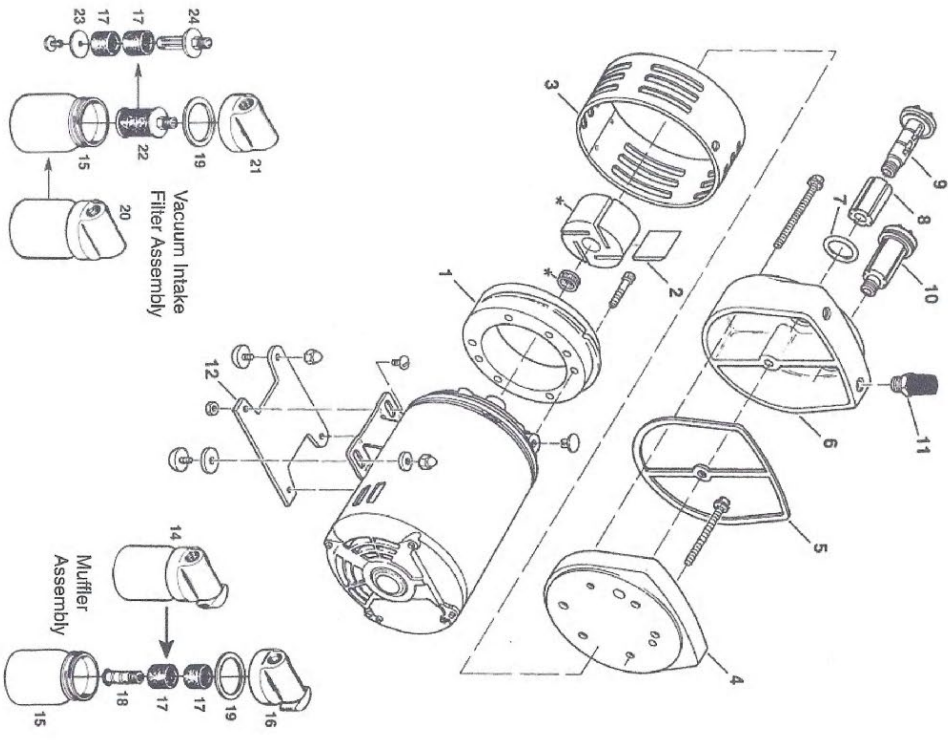

EXPLODED PRODUCT VIEW, PARTS & ORDERING INFORMATION

REF	DESCRIPTION	QTY	0823-101	0823-101Q	1023-101	1023-101Q	1023-V103	1423-101	1423-101Q
1	BODY	1	AK517	AK517	AK518	AK518	AK518	AL283	AL283
2 *	VANE	4	AK513	AK513	AK513	AK513	AK513	AL284	AL284
3	SHROUD	1	AK511	AK511	AK511	AK511	AK511	AL281	AL281
4	END PLATE	1	AK515A	AK514	AK515A	AK514	AK515A	AK515A	AK514
5 *	GASKET	1		AK522		AK522		AK522	
6	MUFFLER BOX	1		AK520		AK520		AK520	
7 *	O-RING	2		AK473		AK473		AK473	
8 *	FELT	2		AK524		AK524		AK524	
9	END CAP	2		AK510		AK510		AK510	
10	END CAP ASSEMBLY	2		AK526		AK526		AK526	
11	FILTER / MUFFLER	1		AK340		AK340		AD432	AC432
12	ELBOW	1						BA206	BA206
12	ELBOW ***	2							
13	MUFFLER ASSEMBLY	1					AF272		
13a	NIPPLE	2					AB599B		
14	JAR	2					AA805	BA714	BA714
15	COVER GASKET	2					AA405		
16	COVER ASSEMBLY	1					AV008BPC		
17	MUFFLER ASSEMBLY	1					AC434-1		
18	COUPLING	2					AC391		
19	CARTRIDGE	2					AC393		
20	END CAP ASSEMBLY	2					AC394		
21	MUFFLER PLATE	1					AC395		
22	STUD	2					AC396		
23	FILTER ASSEMBLY	1					AB599		
24	COVER ASSEMBLY	1					AV005APC		
25	FILTER ASSEMBLY	1					AC433-1		
	SERVICE KIT	1	K479A	K479	K479A	K479	**	K575A	K575A

* Denotes parts included in the Service Kit. Parts listed are for stock models.
 ** No Service Kit available, order parts separately. *** Not shown.
 For specific OEM models, please consult the factory. When corresponding or ordering parts, please give complete model and serial numbers.

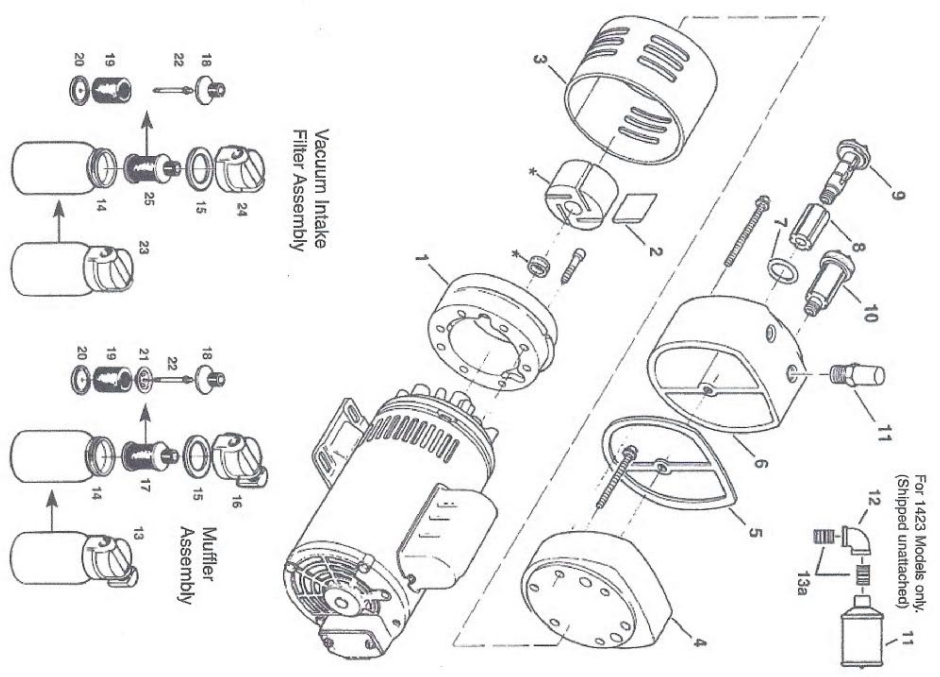

WARRANTY

Gast finished products, when properly installed and operated under normal conditions of use, are warranted by Gast to be free from defects in material and workmanship for a period of twelve (12) months from the date of purchase from Gast or an authorized Gast Representative or Distributor. In order to obtain performance under this warranty, the buyer must promptly (in no event later than thirty (30) days after discovery of the defect) give written notice of the defect to Gast Manufacturing Incorporated, PO Box 97, Benton Harbor Michigan USA 49023-0097 or an authorized Service Center (unless specifically agreed upon in writing signed by both parties or specified in writing as part of a Gast OEM Quotation). Buyer is responsible for freight charges both to and from Gast in all cases.

This warranty does not apply to electric motors, electrical controls, and gasoline engines not supplied by Gast. Gast's warranties also do not extend to any goods or parts which have been subjected to misuse, lack of maintenance, neglect, damage by accident or transit damage.

THIS EXPRESS WARRANTY EXCLUDES ALL OTHER WARRANTIES OR REPRESENTATIONS EXPRESSED OR IMPLIED BY ANY LITERATURE, DATA, OR PERSON. GAST'S MAXIMUM LIABILITY UNDER THIS EXCLUSIVE REMEDY SHALL NEVER EXCEED THE COST OF THE SUBJECT PRODUCT AND GAST RESERVES THE RIGHT, AT ITS SOLE DISCRETION, TO REFUND THE PURCHASE PRICE IN LIEU OF REPAIR OR REPLACEMENT.

GAST WILL NOT BE RESPONSIBLE OR LIABLE FOR INDIRECT OR CONSEQUENTIAL DAMAGES OF ANY KIND, however arising, including but not limited to those for use of any products, loss of time, inconvenience, lost profit, labor charges, or other incidental or consequential damages with respect to persons, business, or property, whether as a result of breach of warranty, negligence or otherwise. Notwithstanding any other provision of this warranty, BUYER'S REMEDY AGAINST GAST FOR GOODS SUPPLIED OR FOR NON-DELIVERED GOODS OR FAILURE TO FURNISH GOODS, WHETHER OR NOT BASED ON NEGLIGENCE, STRICT LIABILITY OR BREACH OF EXPRESS OR IMPLIED WARRANTY IS LIMITED SOLELY, AT GAST'S OPTION, TO REPLACEMENT OF OR CURE OF SUCH NONCONFORMING OR NON-DELIVERED GOODS OR RETURN OF THE PURCHASE PRICE FOR SUCH GOODS AND IN NO EVENT SHALL EXCEED THE PRICE OR CHARGE FOR SUCH GOODS. GAST EXPRESSLY DISCLAIMS ANY WARRANTY OF MERCHANTABILITY OR FITNESS FOR A PARTICULAR USE OR PURPOSE WITH RESPECT TO THE GOODS SOLD. THERE ARE NO WARRANTIES WHICH EXTEND BEYOND THE DESCRIPTIONS SET FORTH IN THIS WARRANTY, notwithstanding any knowledge of Gast regarding the use or uses intended to be made of goods, proposed changes or additions to goods, or any assistance or suggestions that may have been made by Gast personnel.

Unauthorized extensions of warranties by the customer shall remain the customer's responsibility.

CUSTOMER IS RESPONSIBLE FOR DETERMINING THE SUITABILITY OF GAST PRODUCTS FOR CUSTOMER'S USE OR RESALE, OR FOR INCORPORATING THEM INTO OBJECTS OR APPLICATIONS WHICH CUSTOMER DESIGNS, ASSEMBLES, CONSTRUCTS OR MANUFACTURES.

This warranty can be modified only by authorized Gast personnel by signing a specific, written description of any modifications.

MAINTENANCE RECORD

DATE	PROCEDURE PERFORMED

PART NO. 70 - 290 G375PL (REV-G)

TROUBLESHOOTING CHART

Low		High		Pump Overheat	Motor Overload	Reason and remedy for problem.
Vacuum	Pressure	Vacuum	Pressure			
●	●	At pump		●	●	Filter dirty. Clean or replace.
	●		At pump	●	●	Muffler dirty. Clean or replace.
●		At pump		●	●	Vacuum line collapsed. Repair or replace.
			●	●	●	Relief valve set too high. Inspect and adjust.
●	●					Relief valve set too low. Inspect and adjust.
●	●	At pump	At pump	●	●	Plugged vacuum/pressure line. Inspect and repair.
●	●					Vanes sticking. Clean or replace.
●	●					Vanes worn. Replace.
●	●					Shaft seal worn. Replace.
●	●			●	●	Dust or offset powder in pump. Inspect and clean.
●	●			●	●	Motor not wired correctly. Check wiring diagram and line voltage.

AUTHORIZED SERVICE FACILITIES

Gast Manufacturing Inc. 2550 Meadowbrook Road Benton Harbor, MI 49022 TEL: 269-926-6171 FAX: 269-925-8288 www.gastmfg.com	Brenner Fiedler & Assoc 13824 Bentley Place Cerritos, CA 90701 TEL: 800-843-5558 TEL: 310-404-2721 FAX: 310-404-7975 www.brenner-fiedler.com	Hydraulic & Pneumatic Sales 11100 Park Charlotte Blvd. Charlotte, NC 28273 TEL: 704-588-3234 FAX: 704-588-1569 www.hpsales.com	Wainbee Limited 5789 Coopers Avenue Mississauga, Ontario Canada L4Z 3S6 TEL: 905-568-1700 FAX: 905-568-0083 http://www.wainbee.ca	Gast Manufacturing Co., Ltd. Beech House Knaves Beech Business Centre Loudwater, High Wycombe Bucks, England HP10 9SD TEL: 011-44 1628 532600 FAX: 011-44 1628 532470 http://www.gastltd.com
Gast Manufacturing Inc. 505 Washington Avenue Carlstadt, NJ 07072 TEL: 201-933-9454 FAX: 201-933-5545 www.gastmfg.com	D & F Distributors 1144 Indy Court Evansville, IN 47725 TEL: 812/867-2441 FAX: 812/867-6822 www.dfistrib.com	Kinequip, Incorporated 365 Old Niagara Falls Blvd. Buffalo, NY 14228-1636 TEL: 716-694-5000 TEL: 1-800-982-8894 www.kinequip.com	Wainbee Limited 215 boul Brunswick Pointe Claire, Quebec Canada H9R 4R7 TEL: 514-697-8810 FAX: 514-697-3070 http://www.wainbee.ca	Japan Machinery Co., Ltd Central PO Box 1451 Tokyo, 100-91 Japan TEL: 81-3-3573-6421 FAX: 81-3-3571-7865 or: 81-3-3571-7896 www.japanmachinery.com
Air-Oil Products Corp. 301 30th Street NE 31, #112 Auburn, WA 98002 TEL: 800-282-2672 FAX: 877-808-4601 www.air-oil.com	John Henry Foster Co. 4700 Lebourget Drive St. Louis, MO 63134-0820 TEL: 314-427-0600 TEL: 1-800-444-0522 FAX: 314-427-3502 www.jhf.com	James E. Watson & Co. 28 Doran Ave. Marietta, GA 30060 TEL: 770/422-1154 www.jwatsenco.com		



ISO 9001 & 14001 CERTIFIED

www.gastmfg.com

Gast Pump Rebuild

1. ADEC follows the Met One, Inc. recommendation to rebuild BAM-1020 pumps at least once every two years. Use the pump-rebuild kit containing two felt filters, two O-rings, a large gasket, and a set of carbon vanes in the following procedure.
2. If the pump is connected to the BAM-1020, turn the pump off and disconnect the two leads going to the pump relay mounted on the side of the pump, unplug the AC power cord, and remove the vacuum tubing from the pump inlet.
3. Set the pump on a sturdy, flat surface
4. If the muffler is dirty, remove it from the muffler box using a straight-shaft socket wrench. CAUTION! The base of the muffler is made of very soft metal that deforms very easily. Use ONLY a straight-shaft socket wrench to carefully loosen the muffler. You can clean the muffler by blowing compressed air through it.
5. Remove the felt filters by turning the end caps counterclockwise, pulling out the core, and pulling off the used felt filters and the used O-rings. Discard the used filters and O-rings.
6. Loosen the five bolts that hold the muffler box on to the pump end plate. Pull the muffler box off and set aside.
7. Loosen the six bolts that hold the pump end plate onto the pump body. Pull the end cap off and set aside.
8. Remove the old gasket. You may have to use a fine abrasive pad to carefully remove any gasket material that may have fused to the metal parts.
9. Note the direction of the carbon vanes and remove them from their slots and set aside. Clean out the slots.
10. Use a soft brush to clean out the muffler box and the pump end plate. If the end plate is scored, use emery cloth to polish out the scoring. Wipe down the end cap with a soft clean cloth (dampen with a little solvent if necessary).
11. Replace the carbon vanes, making sure that they face in the correct direction. Discard the used vanes.
12. Replace the pump end plate and tighten the six bolts.
13. Replace the gasket and fasten the muffler box to the pump end plate using the five bolts. Discard the used gasket.
14. Replace the felt filter and O-rings on the cores. Re-install the cores. CAUTION: Do NOT use any tools – hand tighten only. Do not over tighten. The cores break easily if over tightened.
15. Reconnect the power leads and the vacuum tubing. Test the rebuilt pump for adequate flow before installing it in a BAM-1020.