

AD-A250 515



Report No. CETHA-IR-CR92004

2

**US Army Corps  
of Engineers**

Toxic and Hazardous  
Materials Agency

**S DTIC ELECTE D**  
MAY 21 1992  
**A**

FINAL

**REMEDIAL INVESTIGATION REPORT:  
WHITE PHOSPHORUS CONTAMINATION OF SALT MARSH  
SEDIMENTS AT EAGLE RIVER FLATS, ALASKA**

Prepared for

U.S. Army Toxic And Hazardous Materials Agency  
Aberdeen Proving Ground, Maryland 21010

Prepared by

U.S. Army Cold Regions Research and Engineering Laboratory  
72 Lyme Road  
Hanover, New Hampshire 03755-1290

Distribution Unlimited

~~Request for This Document Must be Referred to:  
Commander  
U.S. Army Toxic And Hazardous Materials Agency  
Aberdeen Proving Ground, Maryland 21010~~

MARCH 1992

**92-13476**



REMEDIAL INVESTIGATION REPORT:

WHITE PHOSPHORUS CONTAMINATION OF SALT MARSH SEDIMENTS  
AT EAGLE RIVER FLATS, ALASKA

March 31, 1992

FINAL REPORT

TO

U.S. Army Toxic and Hazardous Materials Agency  
Aberdeen, MD

FROM

U.S. Army Cold Regions Research and Engineering Laboratory  
Hanover, NH

CRREL

Charles H. Racine  
Marianne E. Walsh  
Charles M. Collins  
Susan Taylor

DARTMOUTH COLLEGE

Bill D. Roebuck  
Leonard Reitsma  
Ben Steele

Accession For		
NTIS	CRA&I	<input checked="" type="checkbox"/>
DTIC	TAB	<input type="checkbox"/>
Unannounced		<input type="checkbox"/>
Justification		
By		
Distribution /		
Availability Codes		
Dist	Avail and/or Special	
A-1		

## EXECUTIVE SUMMARY

In 1990 personnel from CRREL and Dartmouth College proved that an annual waterfowl dieoff at Eagle River Flats (ERF), an Alaskan salt marsh, was due to the ingestion of highly toxic particles of white phosphorus (WP), which entered the bottom sediments of shallow ponds as a result of past artillery training with WP-containing incendiary munitions. During 1991 the 1990 hypothesis that WP is the cause of waterfowl mortality in ERF was strengthened by: 1) the positive identification of WP in the tissues of an additional 38 dabbling ducks, 4 swans, 9 shorebirds and 1 eagle (all 63 bird carcasses from ERF analyzed during 1990 and 1991 have tested positive for WP); and 2) the finding of WP in an additional 116 sediment samples collected from the bottom of shallow waterfowl feeding ponds.

During the 1991 spring and fall waterfowl migration periods, intensive sediment sampling and avian field studies were conducted around constructed ponds in the six waterfowl feeding pond areas where dabbling ducks feed and where most carcasses have been found. Sediment and tissue samples were analyzed for WP in a nearby field laboratory. Experiments with contaminated sediments and WP were also conducted in the laboratory at CRREL.

Reliable analytical methods (solvent amounts, extraction times and subsample size) were developed to extract WP particulates from ERF sediment samples. In the field, one 20-cm<sup>3</sup> extracted subsample from each 500-cm<sup>3</sup> jar containing the sediment sample provided a reliable determination of the presence or absence of WP but is less reliable in representing the actual concentration of WP in the total 500-cm<sup>3</sup> sample.

Over 400 pond-bottom surface sediment samples were collected at 25-m intervals along transects in the six waterfowl feeding pond areas, representing only 5% of the total area of ERF. The bottom sediments of two of the six sampled waterfowl feeding ponds contained a high percentage of WP-positive samples. In addition the WP concentrations of samples from one of these ponds (Bread Truck Pond) were significantly higher than those from the other ponds. Area C and the Bread Truck ponds, covering an area of about 15 ha (37 acres), are hypothesized to be the major sources of WP duck poisoning in ERF. Over 350 hours of observations of dying ducks and predation on them also supports this hypothesis.

The bottom sediments of the two contaminated ponds in ERF likely contain a large number of very small WP particles (<0.1 mm) and a small number of much larger particles (1 mm). The larger particles could provide a lethal dose (around 0.25 mg) for a small duck such as a green-winged teal. The very small WP particles in the sediments can become suspended in the water column and could provide another source of exposure for waterbirds, fish or plankton. WP poisoning of non-waterfowl species, particularly phalaropes, was documented; however, extensive areas of mudflats used by migrating shorebirds in ERF were not sampled and could contain WP. High rates of predation and consumption of WP-containing duck carcasses by bald eagles, herring gulls and ravens indicate that these species are at risk. WP was detected in the tissues of a dead bald eagle found in ERF.

Evidence suggests that WP is transported within (and to a very limited extent, out of) ERF in birds that have ingested WP but can still fly. Dead waterfowl found in ponds without detectable WP could have ingested the WP in either Area C or the Bread Truck Pond and flown to and died in one of these other areas. Human health risks through consumption of ducks shot in nearby Cook Inlet marshes were found to be minimal; there was no detectable WP in over 300 hunter-harvested duck gizzards collected in September 1991.

The mechanisms by which WP particles enter the pond sediments are unknown but could include smoke projectile air bursts or ground bursts, as well as leakage or subsurface explosion of duds. In the laboratory a burning particle of WP dropped into water contained a significant amount of unoxidized WP. Evidence is also presented that WP may enter the sediments as a result of the decomposition of a WP-poisoned duck carcass.

A literature review of WP remediation techniques showed that ERF is the first documented case of a U.S. artillery training area contaminated with WP particles. In cases of WP contamination from wastewater, WP was oxidized by exposure to oxygen or chemical oxidants. In our laboratory, air-drying and aeration of ERF sediments reduced WP concentrations after several days. Oxidation using hydrogen peroxide accelerated WP oxidation. In ERF a test explosion simulating the detonation of a 105 howitzer projectile was shown to redistribute, not oxidize, WP particles; thus, resumption of summer firing is not a remediation option. A method of monitoring waterfowl mortality in permanent transects was developed and tested and should be used to establish a baseline mortality index for evaluating the success of future remediation.



## TABLE OF CONTENTS

Executive Summary

List of Figures

List of Tables

Acknowledgments

Acronyms and Abbreviations

Section

I. Preface and Introduction

II. Environmental Setting

III. Analytical Methods for the Determination of White Phosphorus in Sediments and Tissue

IV. Isolation and Characterization of White Phosphorus Particles in Sediments and Water

V. Distribution of White Phosphorus in the Sediments of Waterfowl Feeding Ponds

VI. Movement of Poisoned Waterfowl: Transport of White Phosphorus

VII. Waterfowl Mortality Patterns

VIII. Possible Effects on Predators Feeding on Poisoned Waterfowl

IX. Preliminary Human Health Risk Analysis

X. Remediation Techniques: Literature Review and Preliminary Studies

XI. *Report Discussion and Conclusions*

Appendix A. Waterfowl Census 1991

Appendix B. Analytical Method for White Phosphorus in Soils

Appendix C. Sediment Samples Collected and Analyzed during 1991 arranged by Waterfowl Feeding Area in Eagle River Flats.

Appendix C-1. List of All Samples Collected

Appendix C-2. Samples testing positive for white phosphorus and sorted by concentration.

## LIST OF FIGURES

Figure I-1. Map of the Upper Cook Inlet area in southcentral Alaska (inset), showing the location of Eagle River Flats and other estuarine salt marshes used by migrating waterfowl.

Figure I-2. Map of Eagle River Flats salt marsh showing the Eagle River, distributary streams and waterfowl feeding ponds designated as Areas A, B, C, D and C/D, the Bread Truck Pond and the Pond Beyond.

Figure I-3. Observation tower or waterfowl observation blind erected by the U.S. Army 6th ID in Area C.

Figure I-4. Sediment sampling transects, which radiate out from the towers shown in Figure I-3.

Figure II-1. Distribution of ponds and vegetation zones on the east side of Eagle River Flats.

Figure II-2. Aerial oblique view to the northeast across the Bread Truck Pond (named for the yellow panel truck visible on the far edge of the pond).

Figure II-3. Permanent pond in Area D with sediment sample transect markers and small patches of bulrush.

Figure II-4. Submerged aquatic vegetation in a permanent pond bordered by tall bulrush.

Figure II-5. Deep-water channel used by beavers and associated marsh vegetation along the east side of ERF in Area C/D.

Figure II-6. Aerial oblique views of the Bread Truck Pond.

Figure II-7. Aerial oblique view of Area C pond viewed to the north.

Figure II-8. Aerial oblique view to the northwest across Area C.

Figure II-9. Aerial oblique view across a pond in Area B.

Figure II-10. Aerial oblique view to the north across the bulrush vegetation zone between Area C and Area D.

Figure II-11. Two species of bulrush around the edge of the permanent pond in Area C/D.

Figure II-12. Aerial view of Eagle River Flats in January 1991 viewed to the north showing Knik Arm and ice-covered ERF.

Figure II-13. Ice core obtained on a mudflat in Area C in February 1991.

Figure II-14. Salinity and sediment concentrations of ice at 1-cm intervals from the top to the bottom of an ice core obtained over a mudflat area.

Figure III-1. WP concentrations found in four sediment samples after various extraction times on a mechanical shaker.

Figure IV-1. Burning particle of WP prior to hitting the water surface.

Figure IV-2. Particle of WP after hitting the water surface.

Figure IV-3. Rusty-orange residue from burned WP in the laboratory.

Figure IV-4. Particles of WP isolated from a sample collected in Area C.

Figure IV-5. Ranges of masses of particles isolated from five ERF sediment samples.

Figure IV-6. Ranges of lengths of particles isolated from ERF sediment samples.

Figure V-1. Map of Eagle River Flats showing the Eagle River and its distributaries and the percentage of sediment samples that tested positive for WP in each of the six waterfowl feeding areas.

Figure V-2. Number of sediment samples, from all six waterfowl feeding areas of Eagle River Flats, in each of several a) concentration or b) mass ranges.

Figure V-3. Vegetation-habitat map of Area A on the west side of ERF showing the location of sediment sample sites by numbers and/or transect lines.

Figure V-4. Vegetation-habitat map of Area C waterfowl feeding pond area showing the locations of sediment sample numbers along transects lines.

Figure V-5. Percentage of positive-WP sediment samples from the Bread Truck and Area C ponds in each mass range.

Figure V-6. Map of Area C/D on the east edge of ERF between Areas C and D.

Figure V-7. Map of Area D permanent pond in the northeast corner of ERF, showing the distribution of sediment sample transect lines and points in relation to the various types of habitat.

Figure V-8. Map of the Bread Truck Pond and Pond Beyond near the east bank of the Eagle River.

Figure VI-1. Map of the Eagle River Flats area, showing the surrounding lakes (Gwen, Clunie and Otter) where searches for waterfowl carcasses were conducted to determine if WP-poisoned waterfowl were capable of leaving ERF.

Figure VI-2. Outline map of Eagle River Flats showing the movement patterns of various numbers of several waterfowl species.

Figure VI-3. Outline map of Eagle River Flats showing the movement patterns of an immature male mallard.

Figure VII-1. Map of Area C showing the location of the density or D transect surrounding the main pond area in which carcasses were counted in a 1400-m-long  $\times$  10-m-wide belt, and the edge or E transect where carcasses tended to accumulate in large numbers.

Figure VII-2. Habitat map of Area C showing the location of sediment samples testing positive for WP and locations where 22 waterbirds were observed to become sick and die during observation periods in September 1990, May 1991 and August 1991.

Figure X-1. Concentration of WP in an ERF sediment measured as the sample dried.

Figure X-2. Mass of white phosphorus particle and associated water with time.

Figure X-3. Plastic sheets (2  $\times$  3 m) placed 10–16 m from the detonation point to collect sediment blown up and out by the explosion.

Figure X-4. Black plume produced following detonation of 6 lb of TNT and C-4 in a shallow pond in Area C.

Figure X-5. WP concentrations measured in composite samples taken before and after the explosion at detonation point and 10–16 m along north, south, east and west axes.

## LIST OF TABLES

Table I-1. Ponded areas in Eagle River Flats where 1991 integrated sediment and bird studies were conducted, including the area of open water.

Table II-1. Bird species observed during field studies in May and August 1991.

Table III-1. Effect of soil moisture content and soil-to-solvent ratio on recovery of white phosphorus from spiked sediment.

Table III-2. Variability in WP concentrations ( $\mu\text{g/g}$  wet weight) of replicated 20- and 40- $\text{cm}^3$  subsamples (arranged from lowest to highest concentrations) from sample jars containing contaminated sediments from Eagle River Flats.

Table III-3. Concentration of WP in tissues homogenized under nitrogen and room air.

Table III-4. Concentration of WP measured in tissues homogenized in a blender and tissues cut into small pieces.

Table III-5. Concentration of WP measured in tissues stored under various conditions prior to extraction.

Table III-6. Concentrations of WP in various duck tissues collected from carcasses in Eagle River Flats.

Table IV-1. Forms of WP contamination previously described in the environment.

Table IV-2. Particles isolated from ERF sediments.

Table V-1. Results of WP analyses of sediment samples collected in Eagle River Flats at 25-m intervals and at closer intervals (1-10m) along transects during May and August 1991.

Table V-2. Means and standard deviations for concentrations and mass (in 20-cm<sup>3</sup> subsamples) for white phosphorus in the sediment samples testing positive from the bottom of three feeding pond areas.

Table V-3. WP analysis of sediment cores from Area C and the Bread Truck Pond obtained in August 1991.

Table VI-1. WP analysis of tissues from dead waterfowl collected outside Eagle River Flats.

Table VI-2. Waterfowl collected while flying in Eagle River Flats and analyzed for WP.

Table VI-3. Waterfowl trapped and tagged in ERF during the 1991 field season.

Table VI-4. WP analysis of decayed carcasses collected on 30 August 1991.

Table VII-1. Summary of waterfowl mortality counts and estimates made between 1982 and 1990.

Table VII-2. Numbers of carcasses and feather piles either observed or collected between 3 April and 3 November 1988.

Table VII-3. Number of hours spent observing waterfowl and predators in the various areas of Eagle River Flats.

Table VII-4. Percentage of four species of dabbling ducks observed in Area C compared with the percentage of carcasses counted in the edge transect in Area C.

Table VII-5. Tissue analysis for white phosphorus of shorebird carcasses from Eagle River Flats.

Table VII-6. Number of dead ducks counted in each transect and in each area.

Table VII-6. Number of dead ducks counted in each transect and in each area.

Table VII-7. Total number of dead ducks counted on each density transect, the total area searched and the resulting density of dead ducks in Areas A, C, D and the Bread Truck Pond.

Table VII-8. Number of dead waterfowl of each species in density mortality transects counted during August 1991 in each of three vegetation types grouped by areas on the east side of Eagle River Flats (C, C/D, D and the Bread Truck Pond) and for Area A on the west side of ERF.

Table VIII-1. Predation events on ducks observed between 21 and 31 May 1991 from the blind in Area C.

Table VIII-2. Major predators observed to feed on sick or dead ducks at Eagle River Flats between 21 and 31 May 1991.

Table VIII-3. Concentrations of WP in duck tissues from various carcasses collected between 21 May and 3 June 1991 in Eagle River Flats.

Table VIII-4. Concentration of WP in various tissues of duck carcass remains that were observed to be partially consumed by various predators in Area C between 21 and 31 May 1991.

Table VIII-5. Analysis of WP in tissues of predators or predator eggs collected during May or June 1991 in Eagle River Flats.

Table IX-1. Hunting areas and species of dabbling ducks from which gizzards were collected and analyzed for WP.

Table IX-2. Maximum proportion of total population contaminated for various sample sizes and confidence levels for the case where no contaminated ducks are found.



Table IX-3. Estimate of total WP in edible tissues from five ducks that died in ERF.

Table X-1. WP concentrations and soil moisture determined on day 0 and day 17 in an air-dried sample.

Table X-2. WP concentrations found after aerating for 58 days.

Table X-3. WP concentrations found after treatment with hydrogen peroxide.

## ACKNOWLEDGMENTS

Funding for this effort was provided by the U.S. Army Toxic and Hazardous Materials Agency, Aberdeen Proving Ground, MD (Installation Restoration Division). Captain Steven Bird, Project Officer, provided valuable assistance.

The authors gratefully acknowledge many units within the U.S. Army 6th Infantry Division (Light) that provided support. We particularly thank William Gossweiler, Wildlife Biologist, Ft. Richardson DEH for his continued help and encouragement. We acknowledge Laurel Bennet (DEH) for monitoring bird movements, collecting tissue samples and providing her valuable expertise on waterfowl. William Smith (DEH) performed countless tasks, from helping with sample collections to installing bird observations towers. We also thank the helicopter crews of the 6th ID for helicopter services. We are indebted to the personnel of the 176th Ordnance Detachment (EOD) for escorting the sampling parties into Eagle River Flats and for setting up the test explosion.

The Eagle River Flats Interagency Task Force, composed of representatives from the U.S. Fish and Wildlife Service, Alaska Dept. of Fish and Game, Alaska Dept. of Environmental Conservation, and the U.S. Environmental Protection Agency, offered valuable suggestions and helped with field work. Dan Rosenberg (Alaska Dept. of Fish and Game) was responsible for collecting gizzard specimens from hunters in salt marshes neighboring Eagle River Flats. This collection allowed us to assess the possible exposure of hunters to contaminated birds. Bill Eldridge (U.S. Fish and Wildlife Service) harvested ducks from ERF.

Clare Jaeger of the Alaska District Corps of Engineers graciously provided chemistry laboratory facilities and equipment.

Leroy W. Metker of the U.S. Army Environmental Hygiene Agency provided valuable information for assessing human risk.

CRREL personnel provided considerable assistance: Darryl J. Caikins provided administrative assistance and offered technical advice; Patricia Weyrick was responsible for the gizzard analysis, and Elizabeth Nadeau provided assistance. Robert Harris isolated white phosphorus particles.

Dartmouth students also participated in the study. Sae Im Nam, graduate student in toxicology, analyzed many tissue samples and worked on the tissue

method. Gregory Goldfarb, undergraduate biology major, assisted in field work.

This report was prepared by Charles H. Racine, Research Biologist (Sections I, II, V, VI and XI and project management); Marianne E. Walsh, Research Physical Scientist (Sections III, IV, IX, X and XI and chemistry supervision); Charles M. Collins, Research Physical Scientist (Sections II and X and surveying supervision) and Susan Taylor, Research Physical Scientist (Sections II and III). Collins, Racine and Taylor are in the Geological Sciences Branch, Research Division. Walsh is in the Applied Research Branch, Experimental Engineering Division. Bill D. Roebuck, Toxicologist (Sections VIII and IX), Leonard Reitsma, Avian Ecologist (Section VII) and Ben Steele, Avian Ecologist (Section VII), are from Dartmouth College.

This document is being submitted to USATHAMA under the requirements of MIPR-1811. This work is being conducted in accordance with Memoranda USATHAMA, CETHA-IR-A, 1 January 1991, Subject: Scope of work for Ft. Richardson FY91 Eagle River Flats Remedial Investigation.

## ACRONYMS AND ABBREVIATIONS

6th ID	6th Infantry Division
AEHA	Army Environmental Hygiene Agency
C-4	Composition 4 (explosive composition)
COE	Corps of Engineers
CRREL	Cold Regions Research and Engineering Laboratory
DEH	Directorate of Engineering and Housing, 6th Infantry Div.
DIVARTY	Division Artillery
Eh	Redox potential expressed in millivolts
EOD	Explosive ordnance disposal
EPA	U.S. Environmental Protection Agency
ERF	Eagle River Flats
GC	Gas chromatograph
GIS	Geographical information system
HE	High explosive
H <sub>2</sub> O <sub>2</sub>	Hydrogen peroxide
P <sub>4</sub>	White phosphorus or elemental phosphorus
P <sub>4</sub> O <sub>10</sub>	Phosphorus pentoxide
pH	Used to express acidity
ppb	Parts per billion, µg/L or µg/kg
ppt	Parts per thousand, used to express salinity
Rfd	Oral reference dose
TNT	Trinitrotoluene
USATHAMA	U.S. Army Toxic and Hazardous Materials Agency
USFWS	U.S. Fish and Wildlife Service
USGS	U.S. Geological Service
UTM	Universal Trans Mercator

## SECTION I. INTRODUCTION

Over the past two years (1990–1991), an interdisciplinary team of scientists from CRREL and Dartmouth College has investigated the cause and extent of an annual waterfowl dieoff documented since 1981 on Eagle River Flats, a 1000-ha estuarine salt marsh on Cook Inlet at Ft. Richardson, Alaska (Fig. I-1). During the first year of the study (1990), evidence was presented that the cause of the annual dieoff of an estimated 1000–2000 migrating dabbling ducks (*Anas* sp.) and 10–50 swans (*Cygnus* sp.) at Eagle River Flats was the ingestion of white phosphorus particles deposited in the sediments during artillery training (Racine et al. 1991). Evidence that the smoke munition white phosphorus (WP, P<sub>4</sub>) is the cause includes the following:

- Farm-reared adult mallards dosed with WP showed almost identical behavioral symptoms to those of wild ducks observed to become sick and die in Eagle River Flats;
- WP is highly toxic to waterfowl at ingestion levels on the order of 3–5 mg/duck;
- WP was detected by gas chromatography in the gizzard contents and fat of all 11 dabbling ducks and 8 tundra swan carcasses collected in Eagle River Flats in 1990 but in none of five healthy teal collected in a nearby salt marsh; and
- WP was similarly detected in several sediment samples from the bottom of a pond in which ducks feed and were observed to become sick.

ERF is the first documented case of white phosphorus deposition and of wildlife poisoning in a U.S. Department of Defense artillery training area. Before our work at ERF, white phosphorus was dismissed as a possible environmental contaminant because it is thermodynamically unstable in the presence of oxygen (Pourbaix 1966). Because of this instability, as recently as December 1990, in a Health Advisory prepared by the EPA (Gordon et al. 1990) the following statement is made: "It is considered unlikely that elemental phosphorus from smoke devices would deposit to any significant degree into terrestrial or aquatic environments." However, Berkowitz et al. (1981), while assessing the potential health hazards associated with the use of phosphorus smoke munitions, made the following observation:

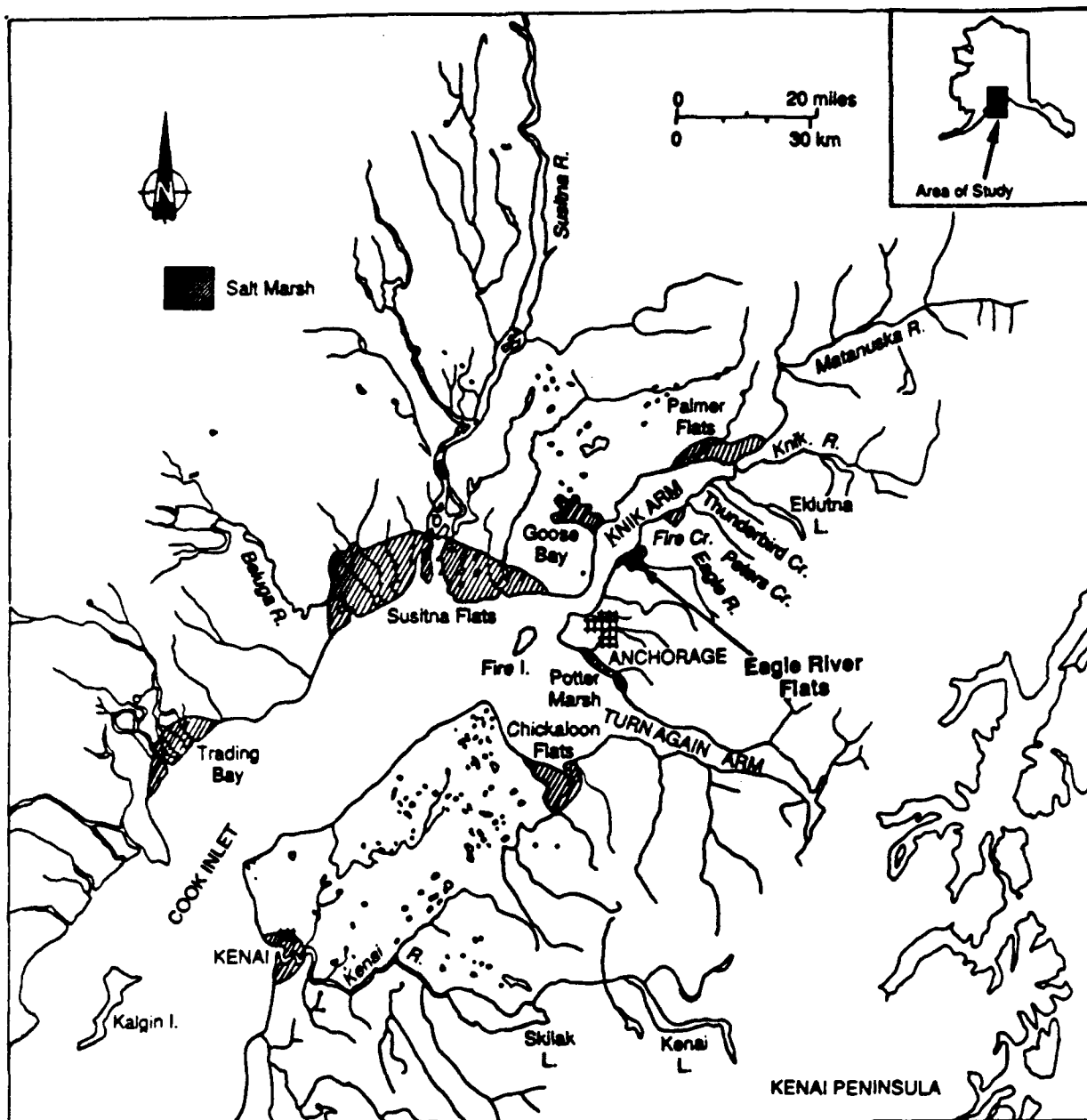

Figure I-1. Map of the Upper Cook Inlet area in southcentral Alaska (inset), showing the location of Eagle River Flats and other estuarine salt marshes used by migrating waterfowl.

Because of the extremely toxic nature of P<sub>4</sub> residues in aquatic systems, deposition/washout of any undegraded P<sub>4</sub>, especially to small water bodies, may create exposure risks to resident finfish, invertebrates, and/or waterfowl, even if resultant P<sub>4</sub> concentrations are in the low ppb range. Unfortunately, there is no information available on the range and frequency of occurrence of P<sub>4</sub> deposition to aquatic systems from...phosphorus...smokes in training or other field use. An area receiving repeated deposition (i.e., training) would be expected to be most vulnerable.

Because salt marsh sediments are highly reduced (Patrick and DeLaune 1977), they are more conducive to storage of the highly reactive WP.

### 1991 OBJECTIVES

This report describes the field and laboratory efforts and the results of the 1991 remedial investigation conducted in ERF. The main purpose of the 1991 effort was to obtain sufficient data to substantiate results from past investigations, to determine the effects of WP contamination on avian species in ERF and to characterize WP contamination in ERF sediments. The specific objectives of this year's work were to:

- Refine analytical techniques for detecting WP in sediments and tissues;
- Determine the spatial distribution and forms of WP particles in the sediments (and water) of waterfowl feeding areas or ponds of Eagle River Flats;
- Obtain a better estimate of mortality in Eagle River Flats and devise a simple but repeatable technique or index to monitor mortality rates from year to year;
- Determine if other sediment-feeding species such as shorebirds are being poisoned by WP and document the use of the area by other species;
- Determine if waterfowl are ingesting chronic or sublethal doses of WP at one site and flying into other areas of Eagle River Flats or out of Eagle River Flats into other Cook Inlet salt marshes;
- Determine the types and rates of predation of poisoned waterfowl and the possible effects on predators;
- Develop a better understanding of WP chemistry, fate and movement in the salt marsh pond environment; and
- Identify potential remediation strategies.

## STUDY DESIGN AND APPROACH

From the beginning of the study we recognized the need to adopt an integrated, multi-disciplinary approach for the study. We felt that only a study that closely integrated biological, chemical and physical studies as well as field and laboratory tests could provide some understanding of the complex environment of Eagle River Flats and the extent of the white phosphorus contamination, as well as providing basic information for remediation options.

The parts of this integrated study included:

- An avian field study program to observe and measure waterfowl mortality, waterfowl behavior, predation, feeding habits, movement patterns and numbers of carcasses;
- A sediment sampling program to further define WP distribution in the shallow ponds used by the waterfowl and relate this distribution to observed patterns of mortality;
- A field laboratory to quickly process and identify the presence of WP in field-collected sediment or tissue samples;
- An experimental program to better understand the detection of and chemical and toxicological properties of WP and to test potential remediation ideas;
- Measurements of physical, chemical and biological environmental variables associated with the ERF ponds in which waterfowl feed and in which WP is stored;
- A remote sensing program to obtain imagery and to map sample sites and various environmental features; and
- A field survey program to locate sampling and collection sites precisely for use in mapping and for eventual input into a GIS system.

All of the field work during both 1990 and 1991 was carried out during the last two weeks in May and August to coincide with the spring and fall waterfowl migration periods. The 1991 field sediment sampling and bird observation studies were centered on four observation towers or blinds constructed under the direction of the Army 6th ID in the major waterfowl feeding pond areas (designated as Areas A, C, C/D and D) (Fig. I-2, I-3). A fifth tower was constructed above ERF at Cole Point overlooking Area B. Two additional ponded areas were recognized during the course of this study: Bread Truck Pond (named for a large yellow panel truck that had been placed



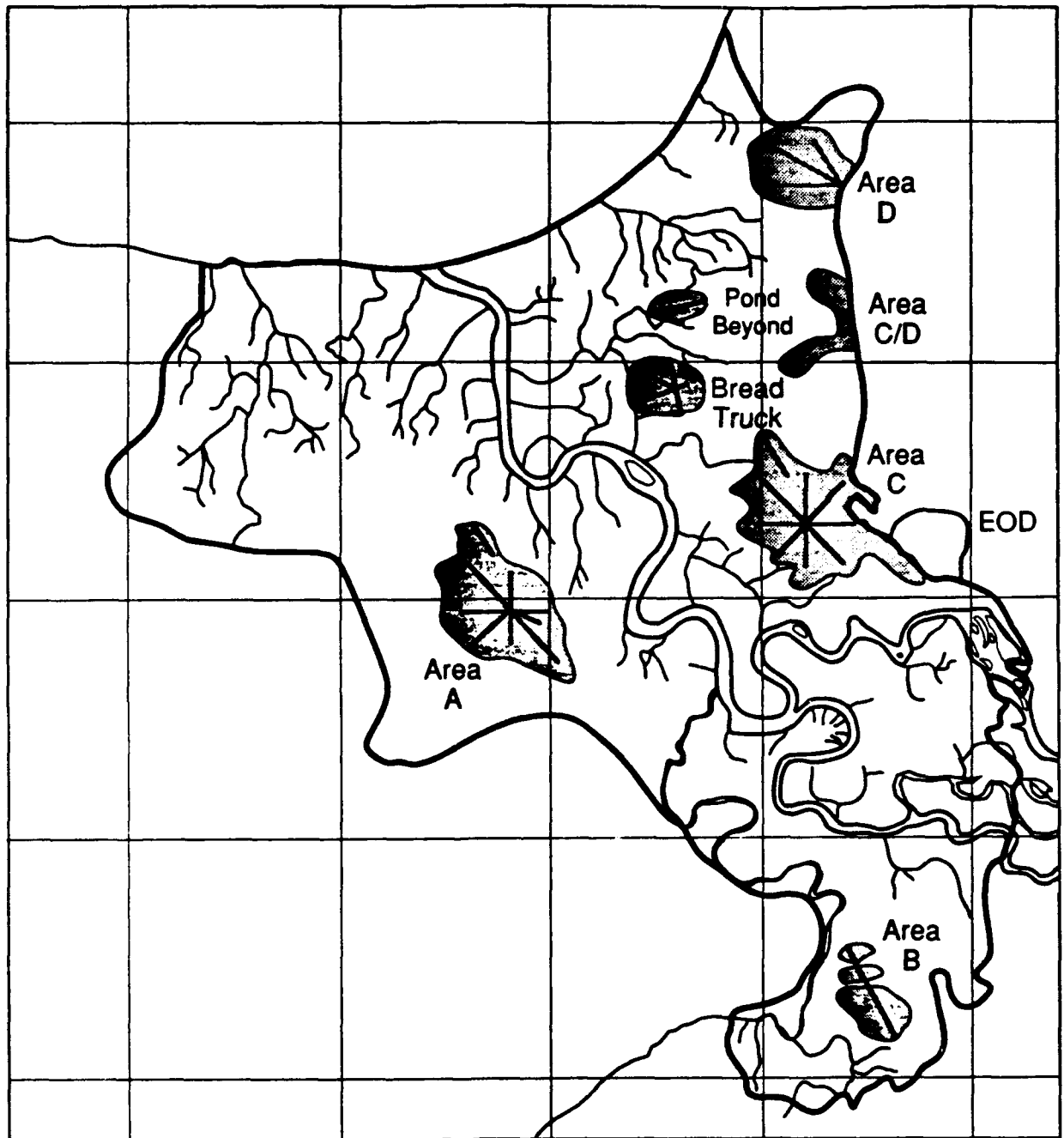
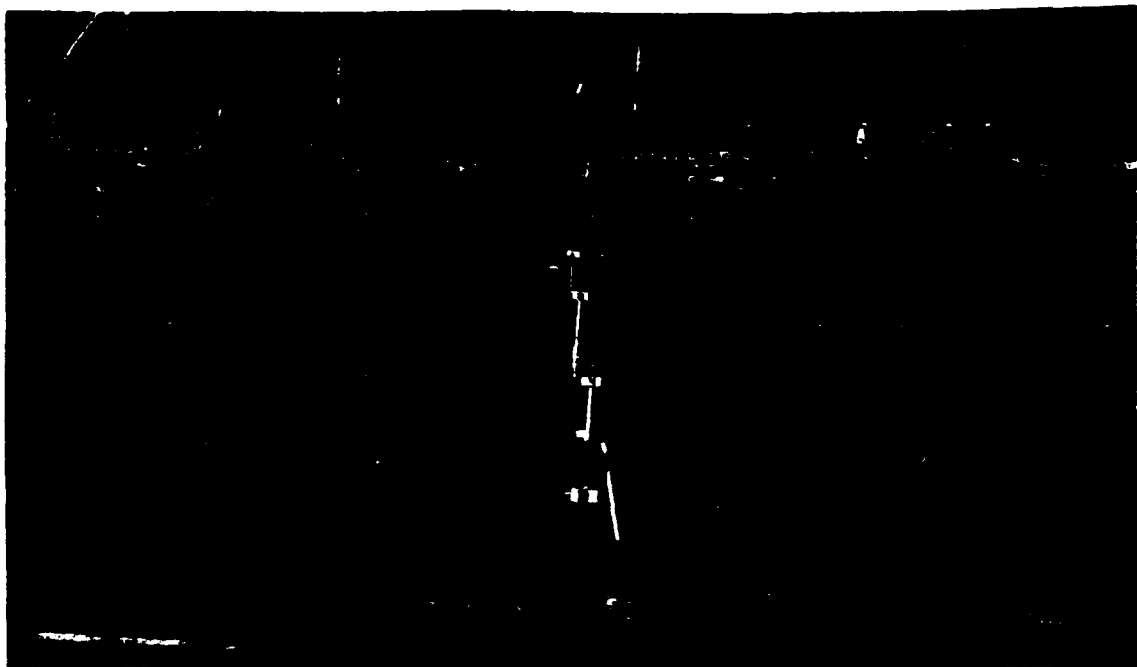

Figure I-2. Map of Eagle River Flats salt marsh showing the Eagle River, distributary streams and waterfowl feeding ponds designated as Areas A, B, C, D and C/D, the Bread Truck Pond and the Pond Beyond. The approximate locations of sampling transects are also shown in each area. The UTM grid lines are 1000 m apart.



*Figure I-3. Observation tower or waterfowl observation blind erected by the U.S. Army 6th ID in Area C. These served to integrate waterfowl and sediment contamination studies.*



*Figure I-4. Sediment sampling transects, which radiate out from the towers shown in Figure I-3. Samples were collected at 25-m intervals, with numbered placards at 50-m intervals providing location information for waterfowl studies.*

here as an artillery target) and two small shallow ponds north of the Bread Truck pond designated here as the Pond Beyond (Fig. I-2). The open water areas associated with all of these feeding areas comprise an area of about 50 ha (125 acres), or 5% of the 1000-ha ERF (Table I-1).

*Table I-1. Poned areas in Eagle River Flats where 1991 integrated sediment and bird studies were conducted, including the area of open water (1 ha = 2.5 acres).*

<u>Location</u>	<u>Area (ha)</u>
<i>West of Eagle River</i>	
Area A	
Main Pond	14.52
Otter Pond	1.84
North End ponds	<u>2.68</u>
Total	18.04
<i>East of Eagle River</i>	
Area C	9.78
Area D	
Main Pond	10.69
Extension	0.90
Area C/D (Beaver Pond)	1.04
Bread Truck Pond	5.10
Pond Beyond	<u>1.80</u>
Total	<u>29.31</u>

The observation towers served as the focus of the sediment sampling and bird observation studies as well as providing a storage site for field sampling equipment and a site for surveying. Radios were used to communicate between towers and between the surveyor and sediment samplers. Sediment collection and bird observation transects were laid out and surveyed in a radiating pattern around each of the towers (Fig. I-2). Sediment sampling sites were positioned at 25-m intervals along these transects and marked with numbered placards and 2-m stakes that allowed the bird observers to better estimate the location and distances to birds they were observing from the tower (Fig. I-4).

The avian study program involved investigations of waterfowl mortality, use, predation and movement patterns within and out of ERF. Most of the observations were made from the towers (Fig. I-3), but ground transects were also established for the purpose of counting carcasses and collecting tissue samples for WP analysis. Over 350 hours of bird observations were logged during the 1991 field season. Tissues were collected from over 60 bird carcasses as a part of this program.

Over 400 sediment samples were collected during the 1991 field season along transects radiating out from the blinds.

The surveying program allowed sediment sampling points, towers, mortality transects and other important features such as vehicle targets in ERF to be located precisely. Over 500 points were surveyed and assigned to a UTM coordinate system for mapping purposes and future relocation.

A field laboratory was set up in Alaska at Elmendorf Air Force Base at the U.S. Army Corps Alaska District lab. This lab permitted the rapid "on-site" analysis of sediment and tissue samples for WP. The results were available within 24 hours after sediments were collected. The quick turnaround allowed areas that tested positive for WP to be resample in more detail to confirm the presence of WP and to refine its distribution pattern. Over 600 samples (sediment and tissue) were analyzed during the 1991 field season.

Additional laboratory experiments with WP were carried out in the chemistry laboratory at CRREL and at the Dartmouth Medical School.

A remote sensing program was established in 1991. A new set of color IR aerial photos and an eight-band multispectral scanner tape (CASI) was obtained of ERF feeding ponds on 21 July 1991 by Aeromap U.S., Inc. (Anchorage, AK). This imagery was used extensively for sediment sampling and bird observation studies in August and used in the preparation of maps. An image processing system being developed at CRREL was used to map vegetation and habitat types and to calculate areas from the CASI tape.

## SECTION II. ENVIRONMENTAL SETTING

### INTRODUCTION

Eagle River Flats at the mouth of the Eagle River is an estuarine salt marsh on the south side of Knik Arm in upper Cook Inlet (Fig. I-1). Estuaries are broadly defined as coastal zones where there is interaction of ocean water, fresh water, land and atmosphere. Beeftink (1977) defines a salt marsh as a "natural or semi-natural halophytic grassland and dwarf brushwood on the alluvial sediments bordering saline water bodies whose water level fluctuates either tidally or non-tidally." Numerous books and studies have been published on salt marsh ecosystems (Chapman 1977, Mitsch and Gosselink 1986, Day et al. 1989). Salt marshes are among the most important coastal wetlands in the world. They are dynamic, complex and highly productive, supporting fisheries, waterfowl and a myriad of other life forms. Salt marshes contain a complex zonation of plants, animals and microbes that is related to the stresses of salinity fluctuations and to the alternate drying and submergence.

In North America, most salt marsh studies have been conducted along the Atlantic (Teal 1986) and Gulf of Mexico (Gosselink 1984). Arctic and subarctic salt marshes in Alaska (MacDonald 1977) and Canada (Jeffries 1977) have received less attention, although they are extensive, particularly along the south shore of Hudson Bay (Glooshenko and Clark 1982, Earle and Kershaw 1989). While some salt marshes along the arctic coasts are strongly influenced by disruptive ice action, ERF is relatively sheltered, with little or no disruption from pack ice. In Cook Inlet, limited descriptions of salt marshes and their zonation are available for Susitna Flats (Snow and Vince 1984), for Kenai Flats (Rosenberg 1986), for Chickaloon Flats (Nieland 1971) and for Potter Marsh (Batten et al. 1978). Below is a description of the zonation and habitats in ERF.

### ECOLOGICAL ZONATION

Vegetated and unvegetated mudflats and various types of marshes and meadows are arranged in zones in relation to the main channel of Eagle

River, its many distributaries and two types of ponds (Fig. II-1). These zones are presumably controlled by the surface elevation, as determined by sedimentation rates and the frequency of tidal flooding (and runoff), which controls the salinity of the soil and water. In addition the distribution and amount of freshwater from streams flowing into ERF affect salinity and the permanence of ponds.

The two types of ponds that serve as the major areas of waterfowl feeding and mortality are semi-permanent and permanent ponds.

**Semipermanent ponds**, or pannes, occur as transitional intertidal ponds from the outer mud flats and low marsh near Eagle River to the freshwater permanent ponds described below (Fig. II-2). They are shallow (3–10 cm) on the outer mudflat side and deepen to 15–50 cm on the landward side. These ponds are best developed in Areas A and C. Both the Bread Truck Pond and Pond Beyond represent semipermanent ponds. An intricate pattern of drainage channels can be seen connecting these semipermanent ponds to the main channel of the Eagle River (Fig. II-2). These channels are probably formed by tidal and rainwater runoff. The ponds or pannes may have formed when the outlet of one of these drains became dammed by vegetation or shifting sediments. The pond also could drain if headward erosion were to cut back into a pond (Mitsch and Gosselink 1989). There are usually clumps and patches of low sedge lawn or tall, coarse sedge marsh in the pond (Fig. II-2). On the deeper (landward) side of these ponds, emergent species such as *Hippurus tetraphylla* and bulrush appear. The area of these ponds may decrease by half during midsummer dry periods. Since the shallow outer areas of these pannes (nearest the river) dry up, most of the submerged aquatic vegetation, such as wigeon grass (*Ruppia*), is located along the inner edge of these ponds.

**Permanent ponds** occur around the edge of Eagle River Flats where freshwater drainages occur (Fig. II-3). Tidal distributaries generally do not extend into these ponds. The innermost ponds occur near the edge of the Flats and are fed by fresh water streams but also occasionally flood during very high tides. The two major areas of permanent ponds include Area D (Fig. II-3) and Area B, both located in embayments and upland edges of ERF. The beaver ponds and channels associated with the transition area between areas C and D (C/D transition) (Fig. II-4) are also well developed examples of permanent ponds. These ponds tend to be deep (25–50 cm) and do not dry up during the summer. The vegetation of these ponds is highly productive and includes

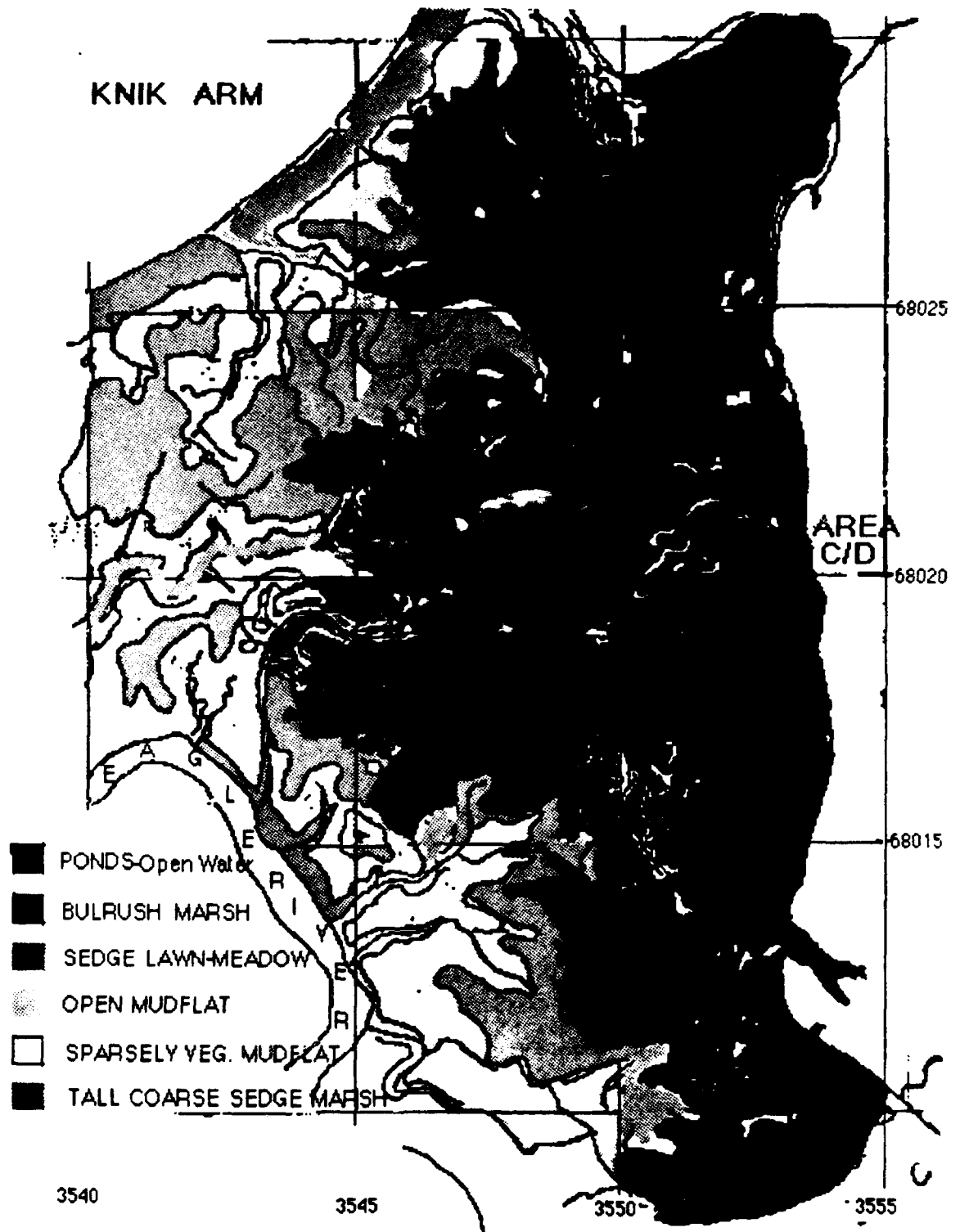
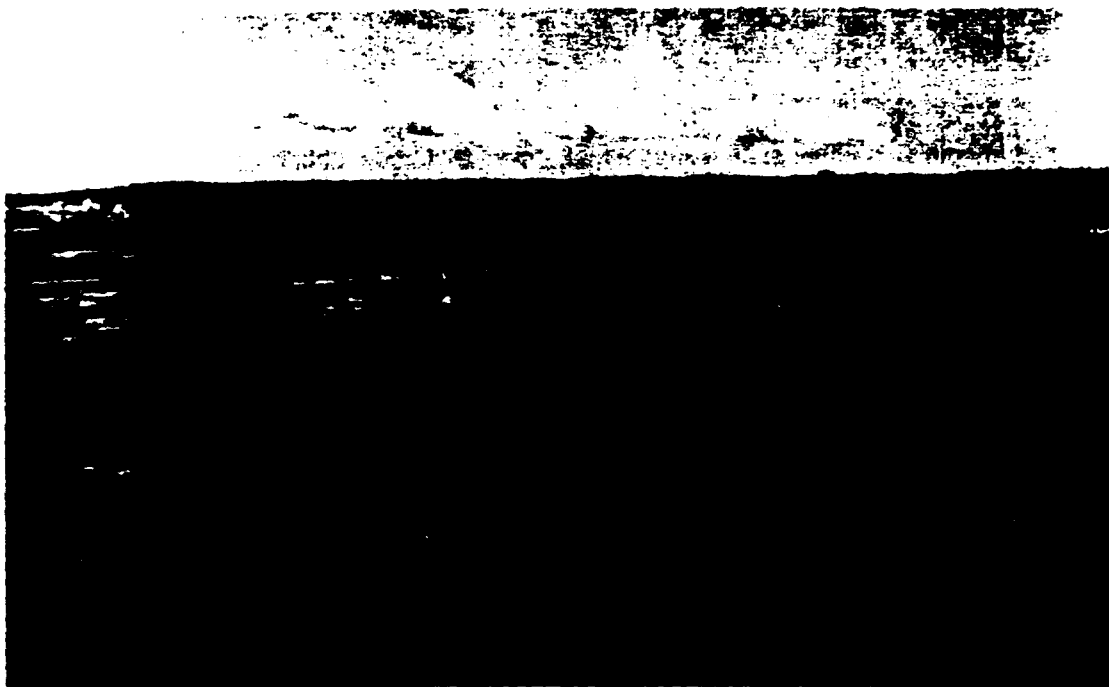
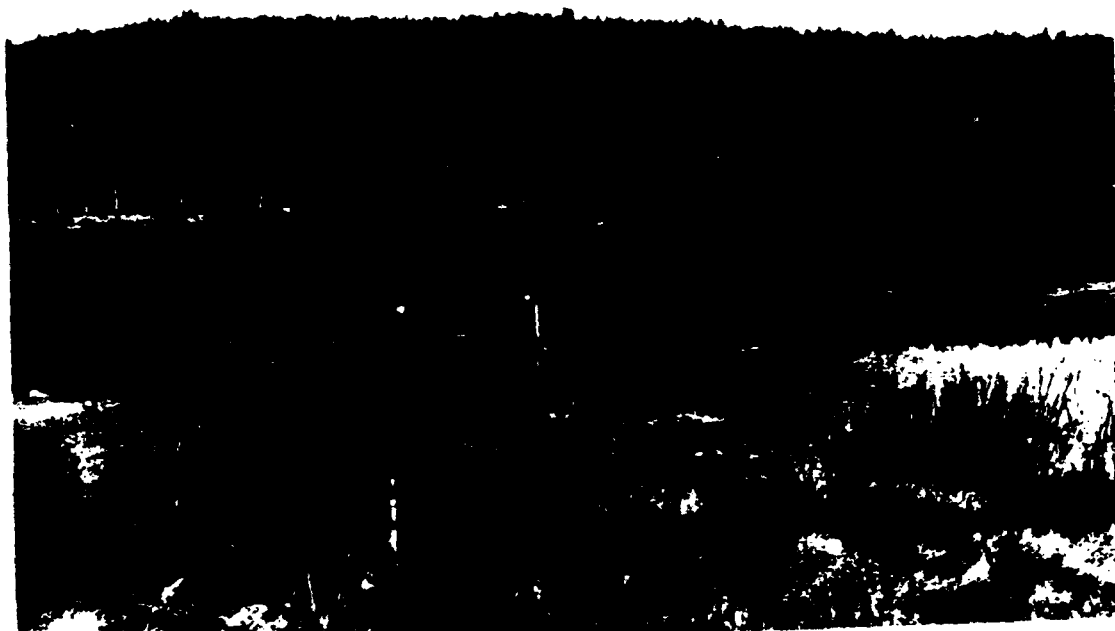

Figure II-1. Distribution of ponds and vegetation zones on the east side of Eagle River Flats. Blue = open water ponds; brown = bulrush; green = short sedge lawn; gray = open mudflat. The UTM grid lines are 500 m apart.



*Figure II-2. Aerial oblique view to the northeast across the Bread Truck Pond (named for the yellow panel truck visible on the far edge of the pond). This is a semi-permanent pond connected to the Eagle River by the distributary and the bare mud bank of the Eagle River visible in the foreground. Water depths vary from 5 cm on the river side of the pond to 30 cm on the upland side.*



*Figure II-3. Permanent pond in Area D with sediment sample transect markers and small patches of bulrush. Water depths here are 25–50 cm, and salinity is less than 7 ppt.*



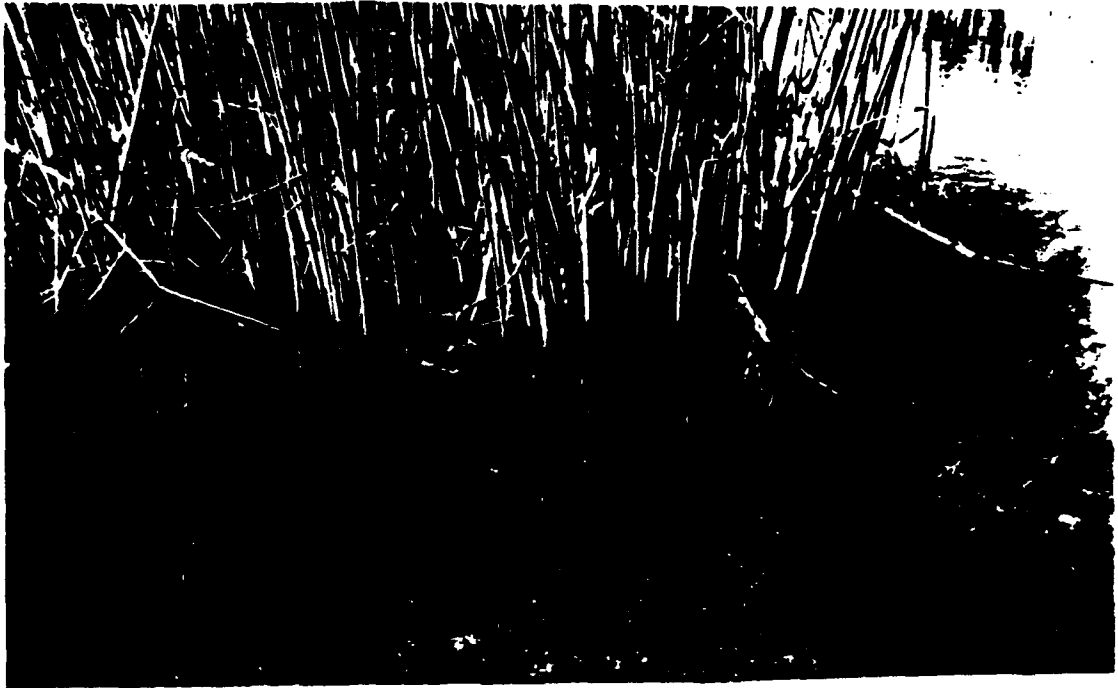

Figure II-4. Submerged aquatic vegetation (wigeon grass: *Ruppia spiralis*) in a permanent pond bordered by tall bulrush (*Scirpus validus*).

well-developed stands of emergent sedges and bulrushes as well as submerged aquatics (Fig. II-5). Along the edges of the permanent ponds in Areas B, D and C/D there are stands of both the very tall, dark green bulrush (*Scirpus validus*) and the lower, brown *Scirpus paladosus*, with occasional transition to tall productive stands of *Calamagrostis* sp. and the shrub *Myrica gale*, near the upland edge (Fig. II-4 and II-5). Because of their high productivity and the relatively low input of glacial silts, the sediments of these ponds are highly organic and very reduced.

During warm, rainless summer periods without high tides, water levels in the semipermanent ponds may drop by 5–10 cm, exposing unvegetated open mudflats along the outer (shallow) edge of these pannes (Fig. II-6). These mudflats are therefore subject to both flooding and drying, which prevent the establishment of vegetation

Closest to the distributaries and Eagle River and interfingering along their edges are sparsely vegetated mudflats dominated by arrowgrass (*Triglochin maritimum*) and alkali grass (*Puccinellia phryganodes*), with occasional patches of goosetongue (*Plantago maritimum*) and the annual glasswort



*Figure II-5. Deep-water channel used by beavers and associated marsh vegetation (bluejoint grass and tall coarse sedge: *Carex lyngbyaei*) along the east side of ERF in Area C/D.*

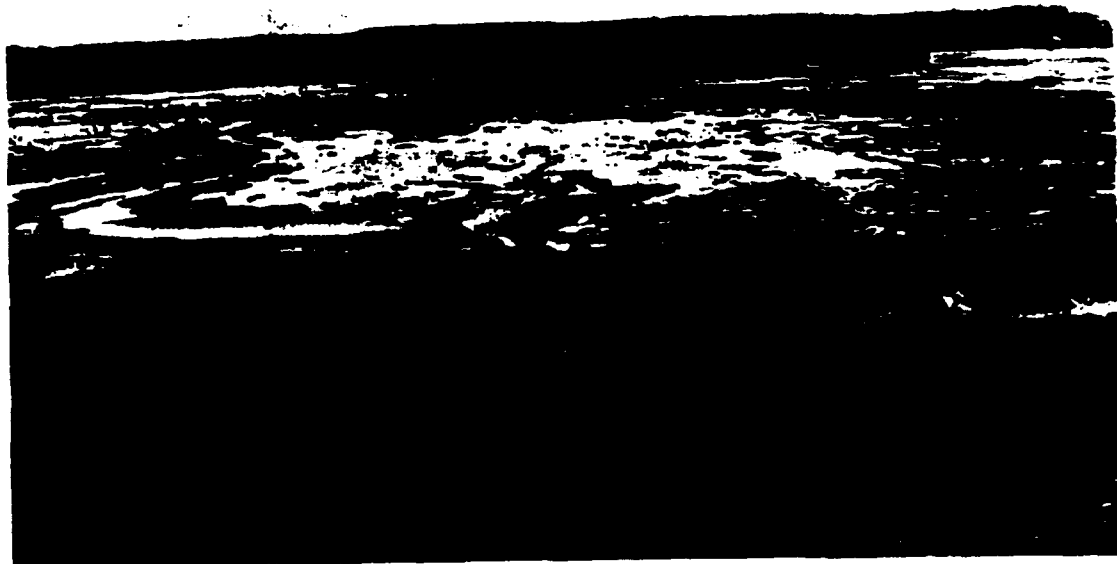

*Figure II-6. Aerial oblique views of the Bread Truck Pond showing the sparsely vegetated mudflat pock-marked with explosion craters and the open mudflat bordering the pond next to the sparsely vegetated mudflat. The vegetated islands and strips are low sedge lawn.*

(*Salicornia europaea*) (Fig. II-6). Virtually all sediment samples that we screened for white phosphorus particles contained seeds of arrowgrass (*T. maritimum*). Closer to the higher edges or levees of some distributaries are tall stands of beach rye (*Elymus arenarius*).

Inside or landward of this sparsely vegetated mudflat zone is a low sedge lawn or dense sedge meadow, consisting of a tightly knit sedge sod dominated by the fine, low sedge *Carex ramenskii*. Other species here include *Potentilla egedii* and *Triglochin* sp. This zone sometimes occurs as islands and isolated strips in the ponds. It is extensive around the observation tower in Area A and is associated with the raised margins of old drainage channels in Area C (Fig. II-7).

The inner edges of ponds are bordered by a bulrush or tall coarse sedge marsh dominated by *Carex lyngbyaei* (Fig. II-8). The sedges are up to 1 m tall, and the roots form a very dense and tight mat (which made the collection of sediment samples particularly difficult). There is standing shallow water over the roots. A well-developed stand of this type borders the EOD pad and extends to the south end of the Area C ponds (Fig. II-8). It is also well developed around Otter Pond at the south end of Area A (Fig. II-9). This tall, coarse sedge zone is by far the most heterogeneous and varies greatly within ERF.



Figure II-7. Aerial oblique view of Area C pond viewed to the north with sparsely vegetated mudflat (foreground) and an old levee with low sedge lawn in the middle of the pond.



*Figure II-8. Aerial oblique view to the northwest across Area C showing the observation blind and well-developed tall, coarse sedge (*Carex lyngbyaei*) vegetation (mixed with darker patches of bulrush) in the foreground.*



*Figure II-9. Aerial oblique view across a pond in Area B showing the border of tall, coarse sedge marsh and bulrush (*Scirpus paludosus*) marsh in the deeper water pond.*

The bulrush marsh zone occupies the inner edge of semipermanent ponds and forms extensive stands in and around permanent ponds. Bulrushes (*Scirpus* sp.) form almost closed stands or more open stands with small pools or ponds (Fig. II-10). Two species of *Scirpus* occur in this zone (*S. paludosus* and *S. validus*) (Fig. II-11) along with occasional patches of the tall coarse sedge (*Carex lyngbyaei*) (Fig. II-8). *S. paludosus* is generally dominant and marked by extensive dead, brownish shoots (Fig. II-9), in contrast with the tall and dark green stands of *S. validus* along the inner edge of this zone (Fig. II-5, II-11) particularly around the permanent ponds. Water depths here are 20–40 cm but where small patches of bulrush occur in the permanent ponds the sediment surface is elevated 10–20 cm above the floor of the pond. These bulrush areas are particularly extensive between the semipermanent intertidal ponds and the permanent ponds east of Eagle River (Fig. II-1, II-10). In Area A, bulrush (*S. paludosus*) occurs extensively in the ponds but appears to be dying. These stands may have been buried by silt because of ground subsidence caused by the 1964 earthquake. Nieland (1971) noted that in Chickaloon Flats the bulrush community was once far more extensive than at present. As in ERF, Nieland also found the most vigorous bulrushes at the edges of the wettest areas with coarse sedge marsh.

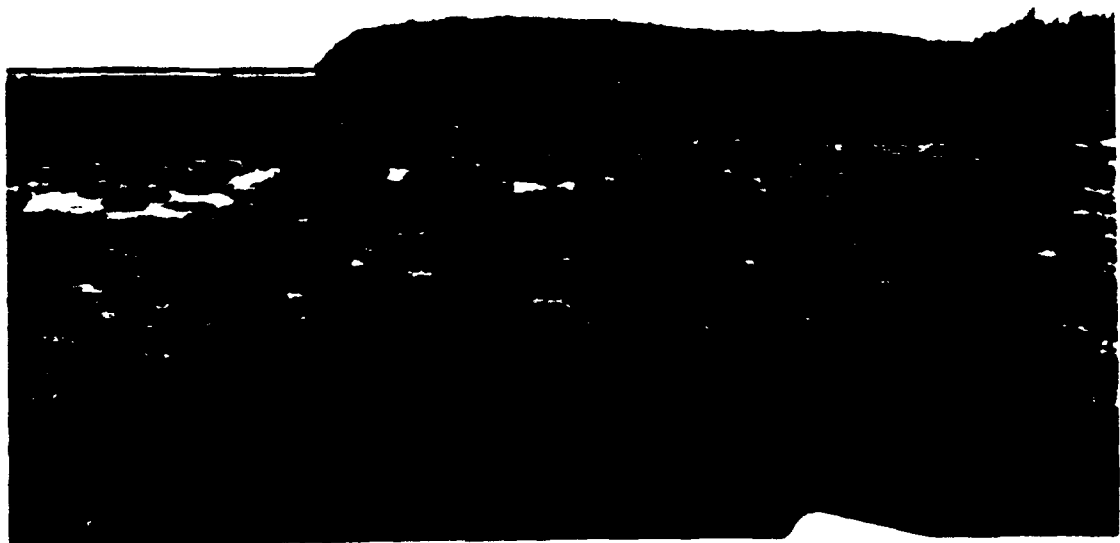

Figure II-10. Aerial oblique view to the north across the bulrush vegetation zone between Area C and Area D. Small open pools and ponds characterize this vegetation type, which is used extensively by mallards.



Figure II-11. Two species of bulrush around the edge of the permanent pond in Area C/D. The tall, dark-green bulrush on the left is *Scirpus validus*, and the lower, yellow-brown bulrush is *S. paludosus*.

## FACTORS CONTROLLING ZONATION

The biological zones in ERF develop because of the following factors: frequency and duration of tidal flooding; deposition and erosion of sediments; soil salinity and regional climate.

### Tidal Flooding

Eagle River Flats and other Cook Inlet and Knik Arm salt marshes are subject to large semidiurnal tidal fluctuations of 9.1–11 m (30–35 ft) during high tide. These represent the second highest tides in North America. Flooding of Eagle River Flats involves both tidal flooding from Knik Arm (Cook Inlet) and fresh water flooding from the Eagle River. The extent and type of flooding (fresh or salt water) depend on both the height of the high tide and the height of the river stage.

During the summer, when the discharge of Eagle River is high due to snowmelt and glacial runoff, an incoming high tide acts to dam the river,



*Figure II-12. Aerial view of Eagle River Flats in January 1991 viewed to the north showing Knik Arm and ice-covered ERF. Otter pond is visible in the foreground.*

causing it to overflow its banks and partially or completely flood the flats. This flooding appears to occur whenever the Anchorage tide tables reported tides greater than about 9.1 m (30 ft). Tides of this magnitude occurred at least 5 times in May 1991, 9 times in June 1991, 9 times in July 1991, 14 times in August 1991 and 18 times in September 1991. Between 16 August and 21 September 1990, 11 flooding events were recorded in an Area C pond.

During the winter, tidal flooding also plays a significant role in the formation of a continuous ice cover over ERF (Fig. II-12). The ice forms not only in the ponds but also covers areas that at low tide during the summer are not normally flooded, such as mudflats, levees and sedge marsh or meadow. In February 1991, mudflat areas had a 30- to 60-cm layer of ice over frozen soils (Fig. II-13). Areas of standing water, such as the ponds, had ice thicknesses of 40–70 cm.

In February 1991, several 4-cm-diameter ice cores were drilled from an Area C pond out toward the river into a sedge marsh (Fig. II-13). Salinity and sediment concentrations were determined at 1-cm intervals along the length of the ice cores.



*Figure II-13. Ice core obtained on a mudflat in Area C in February 1991, showing the frozen sediments (on the right) and frozen ice sediment bands produced by tidal flooding events.*

Thin sections made from an ice core collected over a pond show that about 30% of the length of the core consisted of congelation ice (frozen pond water), 20% was thin ice layers with relatively high salt and sediment concentrations (frozen tidal events), and about 50% was snow ice (wetted and refrozen snow). Freshwater from streams entering ERF along the east side may flow out over the existing ice surface (aufeis) and thereby contribute to the ice thickness over some ponds.

An ice core collected over sedge marsh had standing vegetation incorporated within the ice, and the ice appeared to be composed of about 50% tide-derived ice and 50% snow ice. The concentration of salt (3–6 ppt) and sediment (20–100 mg/g of ice) was fairly high near the base of the core and steadily decreased toward the top of the core. The correlation of high salinity with the presence of sediment bands (Fig. II-14) indicates that sediment-containing salt water from Knik Arm flooded out over the surface of the ice or snow to form a distinct layer.

The mudflat and sedge marsh soils, as well as the bottom sediments of shallow ponds (<10 cm deep), freeze to depths of 30 cm (Fig. II-13). The depth



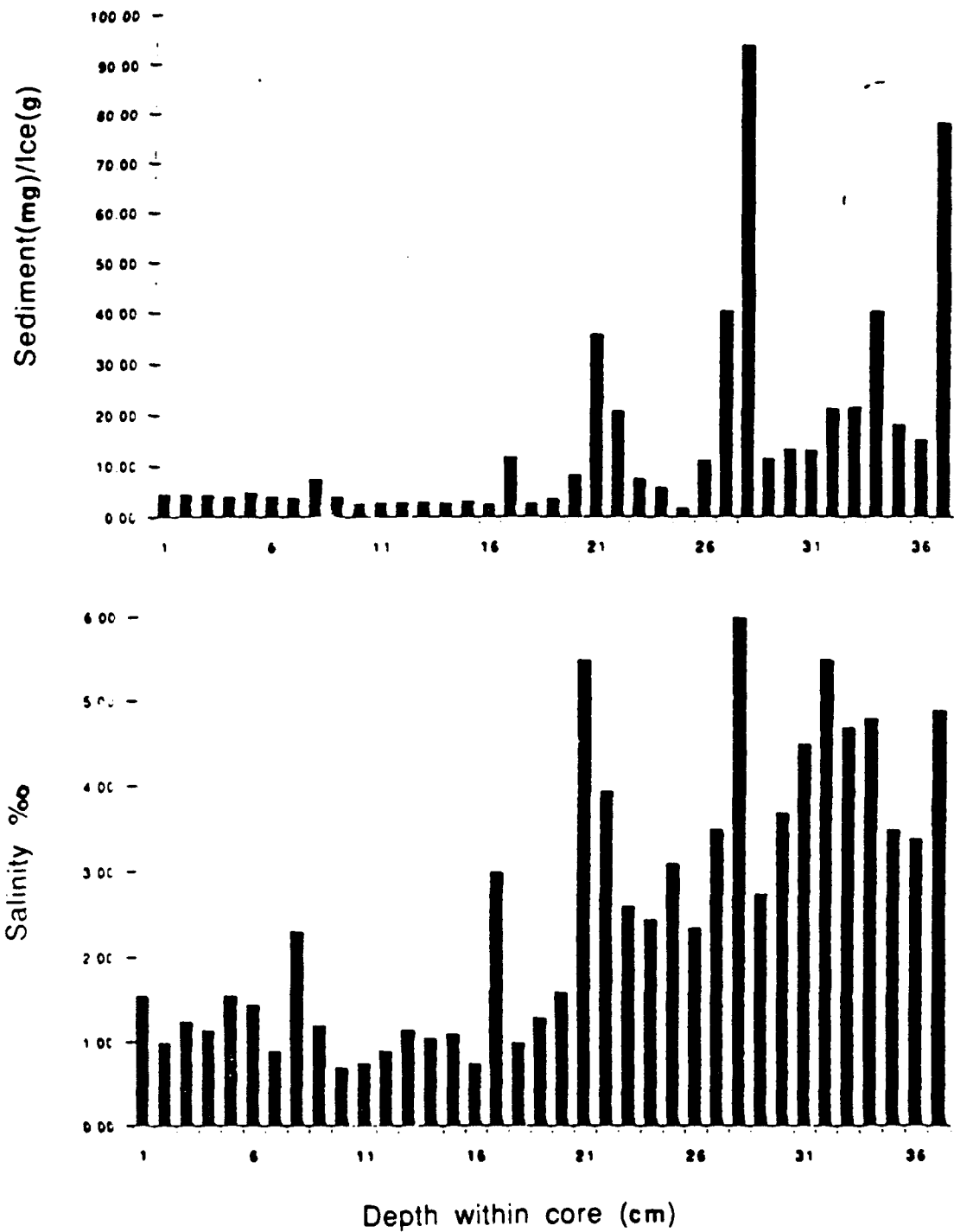

Figure II-14. Salinity and sediment concentrations of ice at 1-cm intervals from the top to the bottom of an ice core obtained over a mudflat area. The correspondence between high salinities and sediments suggests that the ice here formed due to tidal flooding.

of seasonal freezing depends on the depth of the overlying snow cover, the frequency of tidal flooding and the average winter temperatures. Sediments at the bottoms of the deeper ponds (>50 cm) along the edge of ERF probably do not freeze.

It is not known when the ice buildup starts in Eagle River Flats and whether the ice thickness is similar from year to year. Weather factors such as the amount and timing of snowfall and air temperatures all affect the development of the ice cover at ERF.

In spring the ice appeared to melt in situ. A 32-ft tide did not inundate the flats on 16 April 1991 but rather was mostly confined to the main river channel and a few adjacent low areas. Tides appear not to dislodge and remove ice from ERF. By 5 May 1991, ice remained only in the deeper ponds along the edge of ERF, and most of the marker stakes placed in the sediments during summer 1990 were still standing.

#### **Siltation and Sedimentation**

During the summer Eagle River carries a moderate suspended-sediment load derived from glacial melt and runoff. Based on USGS data collected in the early 1970s, a summer mean daily suspended sediment load for Eagle River appears to range between 100 and 300 mg/L but increases to 400–700 mg/L during high discharge periods. The maximum recorded sediment load is 1810 mg/L (USGS 1990). These sediment loads are actually fairly low for glacially fed rivers in Alaska. In comparison the Knik River has a mean daily concentration during the summer of 1400 mg/L, concentrations near 4000 mg/L during high discharge periods and a maximum recorded sediment concentration of 6290 mg/L.

The waters of Knik Arm also contain a moderate suspended-sediment load derived from the glacially fed rivers emptying into it, such as the Matanuska and Knik rivers. Each time ERF is inundated, either by water from Eagle River or by tidal water from Knik Arm, silts and clays settle out of the water or ice covering the flats and are deposited, both on the mudflats and in the shallow ponds. In other areas sediment erosion is no doubt occurring. Sedimentation and erosion processes may play a role in the fate and future distribution of white phosphorus particles.

The 1964 earthquake caused land subsidence of about 0.6 m along the shore of Knik Arm and probably increased flooding and the deposition of sed-

iments at ERF (Small and Wharton 1972). We have not measured sedimentation rates at ERF, but rates determined on other mudflats in upper Cook Inlet (Vince and Snow 1984) are 5–12 mm per year.

The deposited sediments become the substrate of the ponds, mudflats and marshes. Here organic material is incorporated into the sediments as plant and animals die, causing a series of complex chemical reactions. The highly productive salt marsh produces large amounts of organic carbon, which became the basis of oxidation–reduction (respiration) reactions. Since oxygen is rapidly exhausted in these flooded organic-rich sediments, other electron acceptors such as sulfate become important. A major product of sulfate reduction is hydrogen sulfide, whose characteristic odor is pervasive in ERF. Since white phosphorus is highly reducing (it readily donates its electrons), the absence of an electron acceptor (i.e., oxygen) in the highly reduced salt marsh sediments means that WP will persist. One measure of the relative availability of electrons in sediments is the redox potential (Eh). The Eh is zero when there is no free oxygen in the sediments. The lower the redox potential, the slower WP would be oxidized.

Over 200 measurements of sediment redox potential were made during the 1991 field season; these were from different vegetation zones, water depths and sediment types. All had negative values. In Area C, Eh varied from –100 mV on mudflat samples to –400 mV in the black organic sediments associated with bulrush areas. The sediments have pH values ranging from 7 to 8, or neutral to alkaline based on measurements of 36 water and sediment samples from ERF.

Phosphate tests were conducted on dried sediment samples, in hopes that this test could be used to screen for WP, since on drying the WP would theoretically be converted to phosphate ( $\text{PO}_4^{3-}$ ). Because the background levels of naturally occurring phosphates were high in the sediments, it was not possible to use this as a field screening test for WP. Other studies of salt marsh sediments in Georgia have shown that phosphorus (i.e., phosphate) accumulates in high concentrations and does not limit plant growth (Pomeroy et al. 1972).

### Salinity

The salinity of the sediments and water varied seasonally within the flats, particularly in relation to the distance from fresh water inlet streams along the edge of ERF. In the permanent ponds of Areas B, D and C/D most likely

fed by fresh water, the salinity of the water was less than 5 ppt. Salinity of the sediment pore water was usually higher than that of the pond water. In the semi-permanent ponds of Areas A, C and Bread Truck, salinities were higher (10 ppt). The highest salinities (20 ppt) were measured in shallow mudflat pannes and in craters during the winter and spring.

### Climate

The Anchorage area is in the transitional climate zone between the extremes of the Continental and Maritime zones in Alaska. The Alaska Range north and northwest of Anchorage provides a barrier to the influx of very cold air from the Interior. To the northwest and southwest, Anchorage is bounded by the waters of Cook Inlet and Turnagain and Knik Arms (Fig. I-1), which provide a moderating influence on the climate. The average maximum temperature at Anchorage airport is 6.1°C (43°F), the average minimum temperature is -2.2°C (28°F) and the annual mean is 1.9°C (35.4°F). The highest and lowest recorded temperatures are 30°C (86°F) and -37°C (-34°F) (NOAA 1989). The Anchorage Bowl receives 33–51 cm (13–20 in.) of precipitation annually, with the heaviest precipitation in July and August, when the winds are often from the southwest. Air masses move in from the Gulf (southwest) and begin to rise over the Chugach Range east of Anchorage. This produces relatively heavy rainfall along the mountains and can contribute to high runoff events in the rivers draining the Chugach Range, including the Eagle River.

### WILDLIFE USE

The interspersion and zonation of bulrush and sedge marshes, open water ponds and mudflats within ERF provide ideal habitat for large numbers of waterfowl, shorebirds, gulls, terns, raptors and other birds and mammals. Each of these groups is represented by a diverse array of species, as well as an abundance of several species. Because our field sessions were relatively short (two weeks in May and two weeks in August), the species listed (Table II-1) represent only a sample of the species that use the area. Many more species would be included in a complete list.

Table II-1. Bird species observed during field studies in May and August 1991.

Waterfowl		Shorebirds	
American wigeon	<i>Anas americana</i>	Red-necked phalarope	<i>Phalaropus lobatus</i>
Green-winged teal	<i>Anas crecca</i>	Lesser yellowlegs	<i>Tringa flavipes</i>
Northern pintail	<i>Anas acuta</i>	Short-billed dowitcher	<i>Limnodromus griseus</i>
Mallard	<i>Anas platyrhynchos</i>	Pectoral sandpiper	<i>Calidris melanotos</i>
Northern shoveler	<i>Anas clypeata</i>	Common snipe	<i>Gallinago gallinago</i>
Canada goose	<i>Branta canadensis</i>	Wilson's phalarope	<i>Phalaropus tricolor</i>
Tundra swan	<i>Cygnus columbianus</i>	Semipalmated plover	<i>Charadrius semipalmatus</i>
Trumpeter swans	<i>Cygnus buccinator</i>	Hudsonian godwit	<i>Limosa haemastica</i>
Greater white-fronted goose	<i>Anser albifrons</i>	Whimbrel	<i>Numenius phaeopus</i>
Blue-winged teal	<i>Anas discors</i>	Killdeer	<i>Charadrius vociferus</i>
Ring-necked duck	<i>Aythya collaris</i>	Lesser golden plover	<i>Pluvialis dominica</i>
Bufflehead	<i>Bucephala albeola</i>	Solitary sandpiper	<i>Tringa solitaria</i>
Common merganser	<i>Mergus merganser</i>	Western sandpiper	<i>Calidris mauri</i>
Lesser scaup	<i>Aythya affinis</i>		
Sandhill crane	<i>Grus canadensis</i>	Other Birds	
		Violet-green swallow	<i>Tachycineta thalassina</i>
		Rough-winged swallow	<i>Stelgidopteryx serripennis</i>
		Tree swallow	<i>Tachycineta bicolor</i>
		Bank swallow	<i>Riparia riparia</i>
		Cliff swallow	<i>Hirundo pyrrhonota</i>
		Belted kingfisher	<i>Ceryle alcyon</i>
		Rusty blackbird	<i>Euphagus carolinus</i>
		Savannah sparrow	<i>Passerculus sandwichensis</i>
		Lapland longspur	<i>Calcarius lapponicus</i>
Gulls and Terns			
Herring gull	<i>Larus argentatus</i>		
Mew gull	<i>Larus canus</i>		
Arctic tern	<i>Sterna paradisea</i>		
Raptors			
Bald eagle	<i>Haliaeetus leucocephalus</i>		
Common northern raven	<i>Corvus corax</i>		
Northern harrier	<i>Circus cyaneus</i>		
Merlin	<i>Falco columbarius</i>		
Peregrine falcon	<i>Falco peregrinus</i>		
Red-tailed hawk	<i>Buteo jamaicensis</i>		
Rough-legged hawk	<i>Buteo lagopus</i>		
Sharp-skinned hawk	<i>Accipiter striatus</i>		
Kestrel	<i>Falco sparverius</i>		
Northern goshawk	<i>Accipiter gentilis</i>		

The U.S. Fish and Wildlife Service (USFWS) continued to conduct aerial waterfowl surveys of ERF in 1991, as they have done each season since 1988. Appendix A contains a report prepared by William Eldridge (USFWS) describing the results of the 1991 census and comparing these results with those from 1988 through 1990. Most waterfowl use ERF predominantly during the two migration periods: spring (late April to early June) and fall (mid-August to mid-October). During most years there are more waterfowl at ERF in the fall than in the spring. A small population of ducks, cranes and shorebirds remains and breeds in ERF throughout the summer.

### Waterfowl

ERF supports large numbers of green-winged teal, northern pintails, mallards, American wigeons, northern shovelers, Canada geese, greater white-

fronted geese, tundra swans and trumpeter swans during spring and fall migration. The large numbers of species suggest that ERF is an important feeding and resting habitat during migration. In addition, some of these species, mallards at least, breed in ERF.

Less common species include blue-winged teal, ring-necked ducks, buffleheads, common mergansers and lesser scaup. These were seen occasionally in August; blue-winged teal was also seen in May 1991.

Sandhill crane flocks use ERF during migration, and several pairs nest and raise young.

### **Shorebirds**

The mudflats and shallow water at ERF are valuable habitat for large numbers of shorebirds. Red-necked (northern) phalaropes, lesser yellowlegs, short-billed dowitchers and pectoral sandpipers occur in abundance. During May, aggressive mating behaviors were seen in the phalaropes, yellowlegs and pectoral sandpipers. Common snipe are less abundant in both May and August but appear to use ERF for breeding. Other species seen in small numbers in May include Wilson's phalaropes, semipalmated plovers, hudsonian godwits and whimbrels. In August (many shorebirds have migrated south before the last two weeks of August), semipalmated plovers, killdeer, lesser golden plovers, hudsonian godwits, solitary sandpipers and western sandpipers were seen. The abundance of the three species that use the area for mating plus the overall diversity of species indicate that this is an important habitat for shorebirds.

### **Gulls and Terns**

There are 5-10 herring gull nests in ERF. Most nests are in area D, on hummocks of bulrush. Other pairs use the artillery targets as nesting platforms. In addition, numerous other herring gulls are seen on the flats, probably non-breeders feeding on salmon in Eagle River and on duck carcasses and aquatic organisms in the small ponds.

Mew gulls also breed in ERF. There are about ten nests in area D. Arctic terns are common in May and are often seen diving for small fish in the open water.

### Raptors

ERF supports a diverse community of hawks and eagles. Bald eagles are year-round residents. In May, at least four adult and three immature birds used the flats. These probably include adults from nearby nests. Slightly fewer eagles were seen in August, presumably because some birds had moved to rivers to feed on spent salmon. Eagles often perch on targets and driftwood on the flats and on trees along the margins. Spruce trees used as perches on the northeast edge had well-worn, stunted tops, suggesting a long history of roosting by these eagles. These numbers represent a high concentration of eagles for a marsh this size. The abundance of eagles may result from the abundant food in the form of sick and dead ducks (see Section VIII).

Both male and female northern harriers use ERF during spring and fall. Harriers are known to feed primarily on rodents in wet grassy areas but have been seen feeding on dead ducks at ERF. Merlins were seen regularly, eating the abundant dragonflies in August. Peregrine falcons were seen during fall migration, presumably attracted by the abundant shorebirds. Other species seen include red-tailed hawks, rough-legged hawks, sharp-shinned hawks, kestrels and northern goshawks.

### Other Birds

Numerous other species use the Eagle River Flats marsh, the drier sedge areas, the open water and the margins of ERF. A diverse assemblage of swallows used ERF during May. Violet-green, rough-winged, tree, bank and cliff swallows were all seen in abundance. Belted kingfishers fished in the pools on the margins of ERF. Rusty blackbirds were seen in the bulrushes in May and August and may breed here. Savannah sparrows were common throughout the summer and flocks of Lapland longspurs were common in August.

Common northern ravens also occur in abundance. Six to eight ravens use the flats regularly. Ravens also use dead ducks as their primary food resource, although they are subordinate to the eagles and are often chased away from carcasses.

### **Other Animals**

Several species of mammals add to the diversity of wildlife using ERF. Moose frequently wander out onto the flats from the edges. Three coyotes were seen on the flats, and muskrats inhabit bulrush areas.

Wood frogs were especially evident in August, probably representing a major source of food for sandhill cranes.

### **Summary**

Each of these groups of animals considered alone represents a valuable wildlife resource; together these groups indicate that ERF has significant value to wildlife. Not only do large populations occur on the flats, but many species are represented. Thus, we conclude that ERF is an important wildlife resource for this part of Alaska.

The abundance of birds at ERF reflects a productive food chain providing resources to support the higher trophic levels. The great diversity of species results from the diversity of habitats. ERF contains large shallow ponds, sparse sedges, mudflats, craters and expansive bulrush stands interspersed with small ponds. Derelict trucks, placed as targets, provide perches that are not present in other marshes. As such, ERF has more diverse habitat features than surrounding marshes at Goose Bay and Fire Creek. In addition, ducks poisoned by white phosphorus represent an abundant food source for predators not available in other areas.



## SECTION III. ANALYTICAL METHODS FOR THE DETERMINATION OF WHITE PHOSPHORUS IN SEDIMENTS AND TISSUE

### INTRODUCTION

A major objective of our 1991 work at ERF was to determine the spatial distribution of WP in ERF sediments. To meet this objective we needed an analytical procedure to determine WP concentrations in sediment. At present, there is no standard method for the analysis of WP in soil or sediment, although there are published procedures (Sullivan et al. 1989), most of which are variations of the gas chromatographic method developed by Addison and Ackman (1970). Addison and Ackman developed their method to analyze sediments contaminated by the effluent from a WP production facility, so the mode of contamination was quite different from the contamination at ERF. The method we used was based on the work of Addison and Ackman (1970) in that we used isooctane to extract sediment and we used gas chromatography to determine WP concentrations. However, we modified their method by changing the sediment-to-solvent ratio and the extraction procedure as described below.

Also, as part of our 1991 field work, we planned to analyze tissues from carcasses of birds observed to die or found dead at ERF and surrounding areas. Therefore, an analytical method for WP in tissue was also required. Based on published procedures developed for fish tissue by Addison and Ackman (1970), we experimented with extraction conditions and storage procedures for duck tissue.

### SEDIMENT METHOD

#### Soil-to-Solvent Ratio

The method developed by Addison and Ackman (1970) was designed to detect WP in sediments contaminated with colloidal WP. Up to 5 g of wet sediment was extracted with 50 mL of solvent by swirling with 5-mm glass beads in a stoppered flask for 10–15 minutes. The samples were filtered then

extracted again. The filtrates were combined, and the isooctane layer was collected for analysis.

The sediments in ERF are contaminated with particulate WP (Section IV), so the potential for subsampling error is high due to the heterogeneous distribution of WP particles within a sample. While extraction of a large subsample is desirable in that it would better represent the sample as a whole, the size of the subsample that can be efficiently extracted in the laboratory is limited by the mechanics of mixing the non-polar solvent and the wet sediment.

We noticed that samples with low moisture content did not mix effectively with the isooctane; the soil formed a plug on the bottom of the extraction vial, and only the sediment surface was in contact with the solvent. However, samples with high moisture content (greater than 50%) appeared to mix well with the solvent since the sediment remained suspended when shaken. To determine what effect the soil moisture content and the soil-to-solvent ratio had on the amount of WP recovered, we performed an experiment with sediment samples spiked with particulate WP. Due to the difficulties of precisely weighing milligram-size particles of WP, this experiment was only semi-quantitative. Five- and ten-gram dry soil samples were wetted with an amount of water equivalent to half, equal or double the dry weight. To the wetted soil was then added isooctane in proportions of half, equal or double the soil-water weight, and these were spiked with milligram-size pieces of WP. Samples having a low moisture content (<50% water) were observed to form a soil plug, and the isooctane, independent of amount, remained separate from the soil. The amount of WP detected in these low moisture content samples was small relative to that added to the sample (Table III-1, samples 1, 2, 6 and 7).

Samples that contained at least 50% water formed an emulsion when shaken and generally separated into three layers when left standing: a soil layer on the bottom of the vial, followed by a water layer and then an isooctane layer. The recovery of WP was quite variable; however, recovery from samples with high moisture content was consistently higher than for the low-moisture samples. Three of the samples (3, 5 and 9) did not separate but formed a soil layer covered by a frothy soil-water-isooctane layer. Two of these samples had a thin surface layer of isooctane that was sampled. The third sample (9) was centrifuged for 20 minutes, and the resulting isooctane layer was sampled. These three samples had the highest WP recovery (Table III-1).

Table III-1. Effect of soil moisture content and soil-to-solvent ratio on recovery of white phosphorus from spiked sediment.

Sample number	Dry soil mass (g)	Water added (mL)	Isooctane (mL)	Mass of WP added (mg)	Mass of WP recovered (mg)	Recovery (%)	Layers formed
1	10	5	7.5	2.37	0.0088	0.37	soil/iso*
2	10	5	30	1.71	0.0011	0.07	soil/iso
3	10	10	20	0.88	0.621	70.6	emulsion
4	10	20	15	1.99	0.0345	1.74	soil/water/iso
5	10	20	60	0.49	0.419	85.5	emulsion
6	5	2.5	3.75	0.42	0.0015	0.35	soil/iso
7	5	2.5	15	2.17	0.0053	0.25	soil/iso
8	5	5	10	1.16	0.0415	3.58	soil/water/iso
9	5	10	7.5	3.1	2.16	69.7	emulsion
10	5	10	30	1.79	0.609	34.0	soil/water/iso

\*iso = isooctane

The amount of WP detected will depend upon how much time the WP particle is in contact with the isooctane. Adding water to wet soils facilitates this contact by creating a soil-water slurry that can form an emulsion with the isooctane. The quantity of isooctane added is secondary in importance to the added water; if the soil has a low moisture content, large amounts of isooctane are no better than small amounts at extracting the WP. Once enough water has been added to form a slurry, however, increasing the amount of solvent tends to increase the recovery of WP. We found that efficient mixing could be obtained when approximately 20 g of wet sediment (50% moisture on a wet weight basis) was mixed with 10 mL of water and 10 mL of isooctane and shaken horizontally on a platform shaker.

#### Extraction Kinetics

Addison and Ackman (1970) sequentially extracted spiked wet-sediment samples over two 10- to 15-minute intervals. Analyte recovery ranged from 77 to 90%. Since spiked samples do not realistically simulate field-contaminated samples (Jenkins et al. 1989), we performed an experiment using sediments collected at ERF to better define the length of time required to extract WP from wet sediments.

Four sediment samples with estimated WP concentrations ranging from 0.001 (barely detectable) to 1  $\mu\text{g/g}$  were used. Sediments with a wide range of analyte concentration were tested, since extraction kinetics can vary with concentration (Jenkins and Grant 1987). Approximately 10 g of wet sediment was placed in a 40-mL vial containing 10 mL of isooctane and 5 mL of degassed water. Each sample was capped and then vortex-mixed for one minute. A Pasteur pipette was used to withdraw a 0.1-mL subsample of the isooctane layer. Then the samples were shaken horizontally on a platform for 48 hours, with subsamples of the isooctane layer taken at 0.5, 1, 1.5, 7.75, 24 and 48 hours. Prior to sampling the isooctane, each sample was briefly centrifuged, and after sampling each sample was vortexed to resuspend the sediment prior to being placed back on the platform shaker.

For the sample with the lowest analyte concentration, the highest concentration was measured after extended shaking (48 hours); WP was undetectable in the sample shaken less than 7.75 hours (Fig. III-1a). For the two samples at the intermediate WP concentrations, the highest recovery was at 24 and 7.75 hours (Fig. III-1b,c). Extending shaking resulted in analyte loss. For the sample with the highest WP concentration, WP was detectable after 1 minute of vortexing and reached equilibrium after 4 hours of shaking (Fig. III-1d).

Based on these results, a shaking time between 7.75 and 24 hours is optimum. This situation is similar to that obtained for the extraction of explosives of soil (Jenkins and Walsh 1987). For practical reasons, a shaking time of approximately 18 hours is convenient, since samples that are prepared for extraction in the afternoon are ready for analysis the following morning.

#### Method Certification

A spike-recovery study was conducted as described in the U.S. Army Toxic and Hazardous Materials Agency Installation Restoration Quality Assurance Program (USATHAMA 1990). Details of the analytical procedure are given in Appendix B, and a brief description is given here. Subsamples (10 g) of wetted (50% moisture on a wet weight basis) USATHAMA standard soil were spiked with isooctane solutions of WP to yield soil concentrations over the range of 0.004 to 0.08  $\mu\text{g/g}$ . The samples were then treated as described below for field samples. Duplicate samples were prepared and extracted on four consecutive days. A certified reporting limit was calculated using 90% confidence bands about a linear least-squares regression model for found concentrations versus

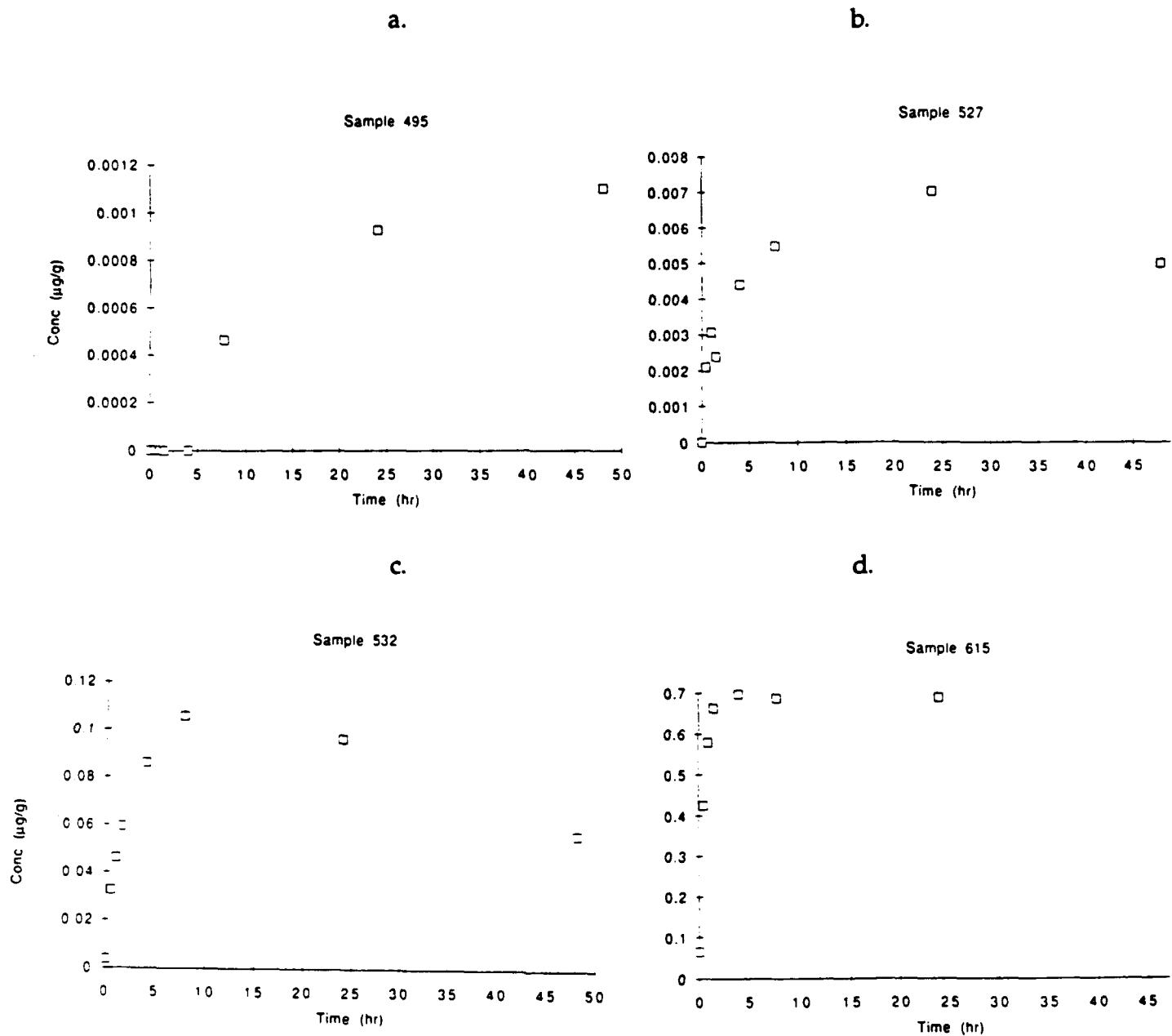

Figure III-1. WP concentrations found in four sediment samples after various extraction times on a mechanical shaker.

spiked concentrations. A reporting limit of 0.0009 µg/g (wet weight) was calculated; however, THAMA protocol does not permit a certified reporting limit less than the lowest tested concentration. When the calculated reporting limit is less than the lowest tested concentration, the certified reporting limit corresponds to the lowest tested concentration (0.004 µg/g for this case). Re-

covery was 97.2%. Certification data were approved by USATHAMA, and the method was assigned the number KN01.

### **Analysis of Field Samples**

#### *Methods*

We set up a temporary field laboratory at the Alaska District Office (COE) on Elmendorf Air Force Base. On the same day as samples (500 cm<sup>3</sup>) were collected, they were brought to the field lab, and a subsample was taken for WP analysis. A plug of wet sediment was removed using a 20-mL corer (a plastic 20-mL syringe with the needle end cut off) and placed into a weighed 120-mL IChem jar containing 10 mL of isooctane and 10 mL of degassed distilled water. The jar was reweighed to determine the sample wet weight. The weight varied because the plug included sediment, vegetation, water and air in differing proportions. Each sample was shaken vigorously by hand and then placed horizontally on a platform shaker overnight. After shaking, the samples were allowed to stand vertically for about 15 minutes. Then a Pasteur pipette was used to transfer an aliquot of the isooctane layer to a 1.5-mL vial. This isooctane extract was then analyzed using gas chromatography (GC).

All samples were analyzed on a gas chromatograph (SRI Model 8610) equipped with a nitrogen-phosphorus detector. The GC conditions were as follows:

Column: J and W DB-1, 15-m, 3.0- $\mu$ m film thickness, 0.53-mm ID

Oven: 80°C (isothermal)

Injection: 1.0  $\mu$ L, on-column

Carrier Gas: Nitrogen, 30 mL/min

Data Acquisition: Peak heights were measured and stored on an HP3396A digital integrator or measured on a linear strip chart recorder.

A WP standard was analyzed during the course of the daily analysis to ensure that the sensitivity of the GC remained constant and to determine the mass of WP in the extracts. For each sample the mass of WP was divided by the wet sediment weight, and the concentrations was expressed as  $\mu$ g/g wet weight.

#### *Sources of Subsampling Error*

Because WP is present in the sediments as particles of different sizes (see Section IV), the mass of WP detected in a 20-cm<sup>3</sup> subsample from a 500-cm<sup>3</sup> jar would depend on the number and size of the particles in the subsample.

We were concerned that if a sample jar contained only a few particles of WP heterogeneously distributed in the sediment, a negative result (i.e. no WP or below detection) might be obtained from a sample that contains WP. To test this possibility we subsampled five samples (collected in the vicinity of contaminated samples) that were negative when analyzed in the field lab. Five subsamples from each of these five sample jars all tested negative. When the remaining contents (200–300 mL) of each jar was extracted, no WP was found. These results suggest that the risk of making a Type II error (false negative, or claiming a sample is blank when in fact WP particles are present) is low. We also took multiple subsamples from samples that we found were positive when analyzed in the field lab. None of the replicates from these samples presented in Table III-2 (all reported as positives in Section V) gave a below-detection (or negative) results, which also supports the conclusion that the risk is low in our data set of claiming the absence of WP in a bulk sample where it is actually present.

The degree to which a single 20-cm<sup>3</sup> subsample represents the actual concentration of WP in a 500-cm<sup>3</sup> sample jar (bulk sample) was also investigated. Multiple 20-cm<sup>3</sup> subsamples taken from single jars show the high variability expected when sampling particulate contaminants ( Grant and Pelton 1974), with the standard deviation being greater than the mean of the subsamples in some cases (Table III-2). Out of four or five subsamples from a single jar, the highest-concentration replicate subsample was 2–50 times greater in concentration than the lowest-concentration subsample (Table III-2). Therefore, one 20-cm<sup>3</sup> subsample taken from each sample jar in the field lab may or may not represent the true concentration in the entire jar. Doubling the size of the subsamples from 20 to 40 cm<sup>3</sup> decreased the replicate variation in only two of the four bulk samples (382 and 278) analyzed.

When four contaminated sample jars were subsampled with four 20-cm<sup>3</sup> subsamples and a 200- to 300-cm<sup>3</sup> sample (the remaining contents of the jar), the mean concentration of the five 20-cm<sup>3</sup> subsamples was very similar to that of the single large subsample (Table III-2) in three out of four samples tested. These results suggest that there are two size classes of WP particles: one class of very small particles that are homogeneously distributed and another class of significantly larger particles that are heterogeneously distributed. In any case a positive result for WP in a sample is evidence for the past use of WP munitions in the vicinity of the sampling point. If a positive result is

Table III-2. Variability in WP concentrations ( $\mu\text{g/g}$  wet weight) of replicated 20- and 40- $\text{cm}^3$  subsamples (arranged from lowest to highest concentrations) from sample jars containing contaminated sediments from Eagle River Flats. A single 200- $\text{cm}^3$  sample was extracted from the contents remaining after removal of four 20- $\text{cm}^3$  subsamples from the last four jars. SD = standard deviation of the mean; CV is the coefficient of variation, or  $\text{SD} \times 100/\text{Mean}$ .

Sample number	Size of sub-sample ( $\text{cm}^3$ )	Conc. rep1	Conc. rep2	Conc. rep3	Conc. rep4	Mean conc.	SD	CV (%)
200	20	0.0055	0.0075	0.0081	0.0113	0.008	0.002	30
	40	0.0061	0.0063	0.0129	0.2620	0.072	0.127	176
382	20	0.0111	0.0113	0.0143	0.5475	0.146	0.268	183
	40	0.0118	0.0136	0.0159	0.0199	0.015	0.003	23
333	20	0.0088	0.0089	0.0125	0.0318	0.016	0.011	69
	40	0.0076	0.0077	0.0197	0.0318	0.017	0.012	71
278	20	0.0703	0.0908	0.0940	0.5237	0.195	0.220	113
	40	0.0934	0.1007	0.1091	0.1478	0.113	0.024	21
561 core	20	0.334	0.449	0.460	0.795	0.510	0.199	
494	20	6.36	26.3	33.4	43.9	27.5	15.8	
223	20	0.0083	0.0090	0.005	0.011	0.008	0.003	
	200	0.095	0.095					
496	20	0.0025	0.0031	0.0042	0.0063	0.004	0.002	
	200	0.0048				0.0048	-	
615	20	0.364	0.410	0.486	0.489	0.437	0.061	
	200	0.521				0.521	-	
527	20	0.002	0.003	0.003	0.006	0.004	0.002	
	200	0.005				0.005		

found, even if the concentration is quite low (i.e.,  $<0.004 \mu\text{g/g}$ ), then areas near the sampling point could be contaminated with particles large enough to provide a toxic dose to a duck.

#### TISSUE METHOD

An analytical procedure for the analysis of WP in fish tissues was developed by Addison and Ackman (1970) in which up to 10 g of tissue was homogenized in a blender for two minutes with 50 mL of isoctane. Then the



isooctane was analyzed by gas chromatography. Based on this analytical approach, we used tissues from farm-reared mallards dosed with WP and from wild birds that died of WP poisoning to better define extraction conditions and tissue storage methods. Additionally the method was used to determine the distribution of WP in the tissues of ducks.

### Homogenization Conditions

Since pure WP oxidizes when exposed to atmospheric oxygen, we were concerned that the air introduced when homogenizing tissues in a blender would result in reduced recovery of WP. We compared WP concentrations in tissues (fat, muscle, skin and liver) homogenized in a nitrogen atmosphere to those homogenized in room air using tissues from mallards gavaged at a dose level of 12 mg/kg as described elsewhere (Racine et al. 1991). Excised tissue was placed in a 40-mL glass vial (Supelco, Bellefonte, PA), and the vial was placed in the nitrogen glove bag. Under the nitrogen atmosphere, the collected tissue was cut into small pieces and placed in a Waring blender with 10 mL of degassed water. The tissue was homogenized for about 30 seconds, and the contents were emptied into a glass vial. Another 10 mL of degassed water was poured into the blender and homogenized for 30 seconds and was added to the original vial. This was followed by the addition of 10 mL of isooctane into the vial. Then the tightly capped vial was removed from the nitrogen bag and placed on a rotating shaker for 24 hours. For comparison, tissues were collected and homogenized as described above but were homogenized in room air. The WP concentration in each tissue sample was measured by gas chromatography (Table III-3). No significant difference was found when the results were compared using a paired t-test at the 95% confidence level.

The tissue homogenization process described above was problematic in two important ways. First, it was difficult to recover all of the tissue from the blender container, and cleaning the blender to prevent cross contamination between samples was very time consuming. We used tissues from waterbirds (one green-winged teal, one mallard and one sandpiper) that died of WP poisoning at ERF in May 1991 to compare WP concentrations in tissues homogenized in a blender as described above to tissues that were simply cut into small pieces followed by extraction with isooctane. The latter procedure is easily performed in the field. WP concentrations were consistently higher in tissues that were cut, not blended (Table III-4).

Table III-3. Concentration of WP in tissues homogenized under nitrogen and room air.

Tissues	WP Concentration ( $\mu\text{g/g}$ )			
	Duck 1	Duck 2	Duck 3	Duck 4
<b>Breast Muscle</b>				
Nitrogen Atm.	0.033	0.025	0.120	0.038
Room Atm.	0.025	0.018	0.065	0.038
<b>Liver</b>				
Nitrogen Atm.	0.150	0.040	0.680	0.365
Room Atm.	0.045	0.430	0.530	0.080
<b>Fat</b>				
Nitrogen Atm.	3.30	2.04	3.52	1.41
Room Atm.	NA	2.76	3.50	1.99
<b>Skin</b>				
Nitrogen Atm.	1.02	1.16	2.22	1.42
Room Atm.	NA	1.04	2.28	1.53

Table III-4. Concentration of WP measured in tissues homogenized in a blender and tissues cut into small pieces.

Tissues	WP Concentration ( $\mu\text{g/g}$ )		
	Teal	Sandpiper	Mallard
<b>Muscle</b>			
Blended	0.0056	0	0.0045
Cut	0.022	0.006	0.0043
<b>Fat</b>			
Blended	0.55	0.19	NA
Cut	1.30	0.47	NA
<b>Skin</b>			
Blended	0.24	0.14	0.024
Cut	0.44	0.33	0.065

### Storage of Tissues

While we planned to analyze some tissues in our field lab in Alaska, we also proposed to ship some tissues back to CRREL for more detailed analyses. Therefore, we needed to test some tissue storage methods. Two tissue storage procedures were tested prior to the May field trip using tissues collected from mallards dosed in the laboratory. Some of the tissue samples excised from the treated mallards were placed in a nitrogen-purged vial prior to being frozen and stored at  $-20^{\circ}\text{C}$  for one week. Other samples were simply placed in a vial, frozen and stored at  $-20^{\circ}\text{C}$  for one week prior to extraction. Additionally, to simulate tissues collected from a carcass that is not fresh, approximately half of the duck was wrapped with wet paper towels and left at room temperature for 24 hours exposed to the atmosphere prior to tissue collection. All these tissue samples were collected and homogenized under a nitrogen atmosphere.

Freezing the WP-containing tissue had no significant effect on the WP concentration (Table III-5). This finding agrees with the results of Dyer et al. (1972); they concluded that WP decomposition was very slight in cod muscles that had been frozen. Additionally the WP concentrations in tissues collected from the carcasses aged for 24 hours at room temperature were not significantly different from tissues collected and extracted immediately after death.

### Distribution of WP in Tissues

Prior to the May field trip, we wanted to identify which tissues are likely to have the highest WP concentration. Identifying such a tissue would facilitate sampling of carcasses for WP poisoning. For all four birds dosed in the laboratory (Table III-6), the highest WP concentration was found either in the lower intestine or in the fat. WP concentrations in the skin nearly equaled the fat concentrations. This finding was consistent with expectations, since WP is very lipid-soluble. The lowest concentrations were in the breast muscle. All tissues that were sampled for WP were positive, except for the blood samples.

Accumulation of WP in the tissues of marine animals has been studied extensively (Sullivan et al. 1979). WP concentrations were directly correlated with lipid content. For example, the liver of cod had the highest WP concentrations for that species. For ducks, collection of fat and/or skin with subcutaneous fat would provide a sample suitable for WP analysis.

*Table III-5. Concentration of WP measured in tissues stored under various conditions prior to extraction.*

Tissues	WP Concentration ( $\mu\text{g/g}$ )			
	Duck1	Duck2	Duck3	Duck4
<b>Breast Muscle</b>				
No storage	0.033	0.025	0.120	0.038
Nitrogen/Frozen.	0.043	0.020	0.073	0.028
Air/Frozen	0.040	0.028	0.045	0.035
Air/Room Temp.	0.038	0.025	0.013	0.027
<b>Liver</b>				
No storage	0.15	0.040	0.68	0.36
Nitrogen/Frozen.	0.020	NA	0.60	0.18
Air/Frozen	0.020	NA	0.50	0.095
Air/Room Temp.	NA	NA	NA	NA
<b>Fat</b>				
No storage	3.3	2.04	3.5	1.4
Nitrogen/Frozen.	NA	NA	3.4	1.1
Air/Frozen	NA	NA	3.7	1.5
Air/Room Temp.	2.0	2.03	NA	NA
<b>Skin</b>				
No storage	1.0	1.2	2.2	1.4
Nitrogen/Frozen.	NA	NA	1.8	1.2
Air/Frozen	NA	NA	2.0	1.1
Air/Room Temp.	12	10	15	12

### **Sample Processing and Analysis During the May and August Field Trips**

Tissues from some birds found dead or observed to die at ERF during the May and August field trips were excised in the field, cut into small pieces, and then placed directly into weighed vials containing 10 mL of isooctane. These samples were returned to the field lab, shaken overnight on a platform shaker, and then analyzed using the same chromatographic conditions as for sediment samples. Some whole birds were frozen and shipped to the Dartmouth Medical School for detailed analysis. Samples from these birds were processed as soon as the carcass thawed sufficiently to allow tissue collection.

Table III-6. Concentrations of WP in various duck tissues collected from carcasses in Eagle River Flats.\*

Tissue Samples	WP concentration (ug/g)			
	Duck 1	Duck 2	Duck 3	Duck 4
Brain	0.030	0.050	0.060	0.050
Breast Muscle	0.033 + 0.007	0.025 + 0.003	0.120 + 0.045	0.038 + 0.009
Body Fat	3.300	2.040	3.515 + 0.495	1.410 + 0.070
Heart	0.145 + 0.045	0.150 + 0.010	0.290 + 0.050	0.265 + 0.015
Kidney	0.270	0.130	0.150 + 0.010	0.050
Lower Intestine	0.390	5.290	1.910	4.580
Upper Intestine	0.700	0.180	0.820	0.420
Proventriculus	0.220	0.250	0.920	0.470
Leg Muscle	0.360 + 0.240	0.350 + 0.050	0.330 + 0.190	0.215 + 0.045
Liver	0.150 + 0.090	0.040	0.680 + 0.020	0.365 + 0.005
Skin	1.020 + 0.090	1.157 + 0.009	2.225 + 0.015	1.425 + 0.015
Gall bladder		0.320	0.360	
Testes	0.050 + 0.010	0.040		
Egg Yolk			0.300	0.040 + 0.020
Blood	0	0	0	0

\*The majority of the tissue samples were taken in duplicates, but some were taken in singles, triplicates or quadruplets. Duck 1 was 1.05-kg male; duck 2 was a 1.1-kg male; duck 3 was a 1.2-kg female; and duck 4 was also a 1.2-kg female.



## SECTION IV. ISOLATION AND CHARACTERIZATION OF WHITE PHOSPHORUS PARTICLES IN ERF SEDIMENTS AND WATER

### INTRODUCTION

Because sediment-feeding waterfowl are the principal victims of the poisoning at ERF, we hypothesized (Racine et al. 1991) that the white phosphorus is ingested by ducks as a particle in a manner similar to the ingestion of lead shot (Friend 1987). WP particles ingested by waterfowl should be in the size range of other food items selected by dabbling ducks (Nudds and Bowlby 1984). We also hypothesized that the source of these particles is WP-containing incendiary munitions fired into ERF. The bursting charge ignites the WP and burning particles fall onto the water surface, where they are extinguished and settle onto the sediments. During winter tests of obscurants, Cragin (1984) observed "globules" of partially burned WP on the snow surface within a 60-m radius after a static ground-level detonation of a 12.7-cm Zuni rocket containing 8.9 kg of WP. While we hypothesized that particles generated by the WP cloud and burning globules are the source of contamination as measured in extracted sediment samples, the sizes, shapes and other characteristics of these particles that result in their consumption by waterfowl were unknown.

Several forms of WP have been recognized, including colloidal (fine particles suspended in water), dissolved and particulate (Table IV-1). WP has very low solubility in water (3 mg/L). Most of the research on WP has concentrated on the colloidal form that occurs in wastewater from the manufacture of WP and WP munitions. We may have detected this form when a fine-mesh net was towed through the pond water in Area C as described below. Such very fine particles of WP could have been deposited from the smoke cloud resulting from the deployment of the WP munition.

To gain some understanding of the form of the WP present in contaminated sediments, in the laboratory, we:

- Dropped a burning WP particle into water and measured the residual WP;
- Sieved contaminated sediments from ERF to isolate WP particles; and
- Used a fine-mesh plankton net to collect suspended material in the water column of contaminated ponds.

Table IV-1. Forms of WP contamination previously described in the environment.

Activity	Form of WP	Location of contamination	Mode of transport to environment	Reference
Manufacture of WP	1) Colloidal (0.45 -1 $\mu\text{m}$ )	1) Long Harbour, Newfoundland	Wastewater	Jangaard (1972)
	2) Dissolved (3 mg/L)	2) Muscle Shoals, Alabama		
Manufacture of WP munitions	1) Colloidal	Pine Bluff	Wastewater	Blumbergs et al. (1973)
	2) Dissolved	Arsenal, Arkansas		
Training	1) Particles from unburned WP ?	ERF first documented case	Deployment of smoke rounds	Racine et al. (1991)
	2) Particles deposited from smoke cloud ?			

## ESTIMATE OF UNREACTED WP IN BURN RESIDUE

We estimated the amount of unburned WP remaining when a burning WP particle drops into water by performing the following experiment.

### Methods

An approximately 30-mg piece of WP (Aldrich Chemical Co) was held in a spatula over a jar containing 250 mL of water. A match was used to ignite the piece of WP, which melted upon inflammation. The spatula was then inverted, dropping the brightly burning WP onto the surface of the water (Fig. IV-1). As the particle hit the surface of the water, it splattered into several smaller pieces. Some pieces sank and were immediately extinguished; other pieces floated on the water surface, where they continued to burn for about 30 seconds (Fig. IV-2). When all burning had stopped, isooctane was used to extract the residual WP from the water. For comparison, we ignited another



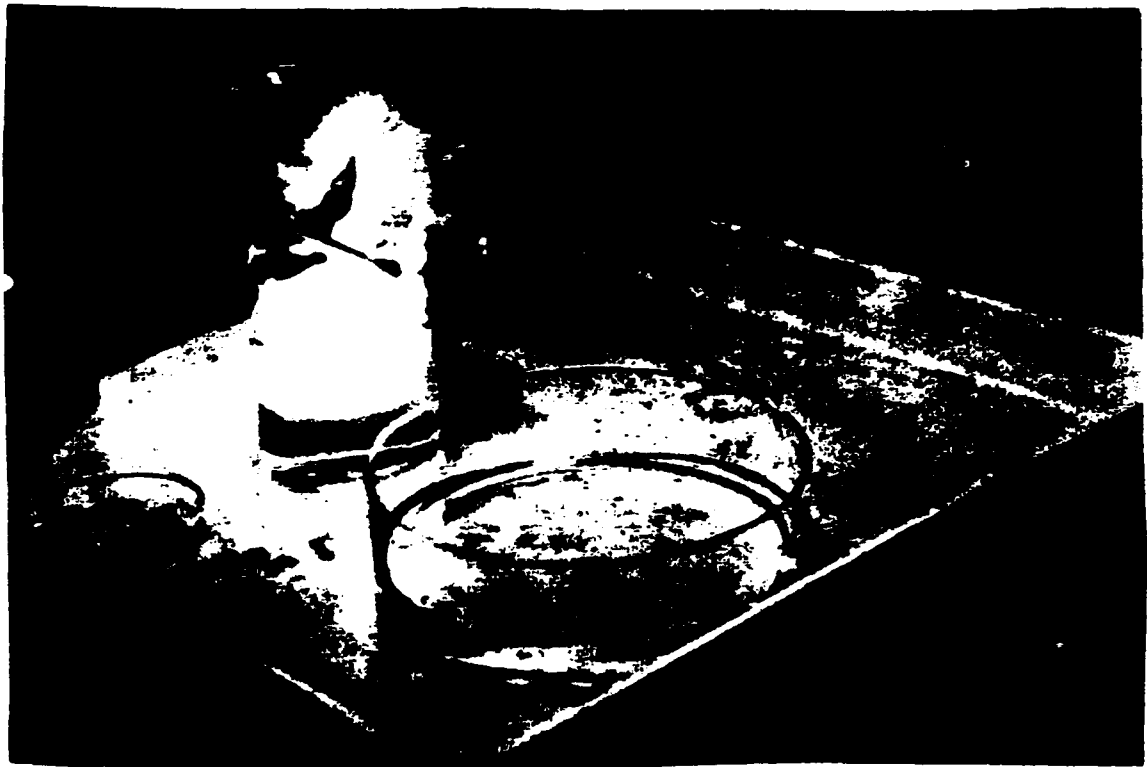

*Figure IV-1. Burning particle of WP prior to hitting the water surface.*

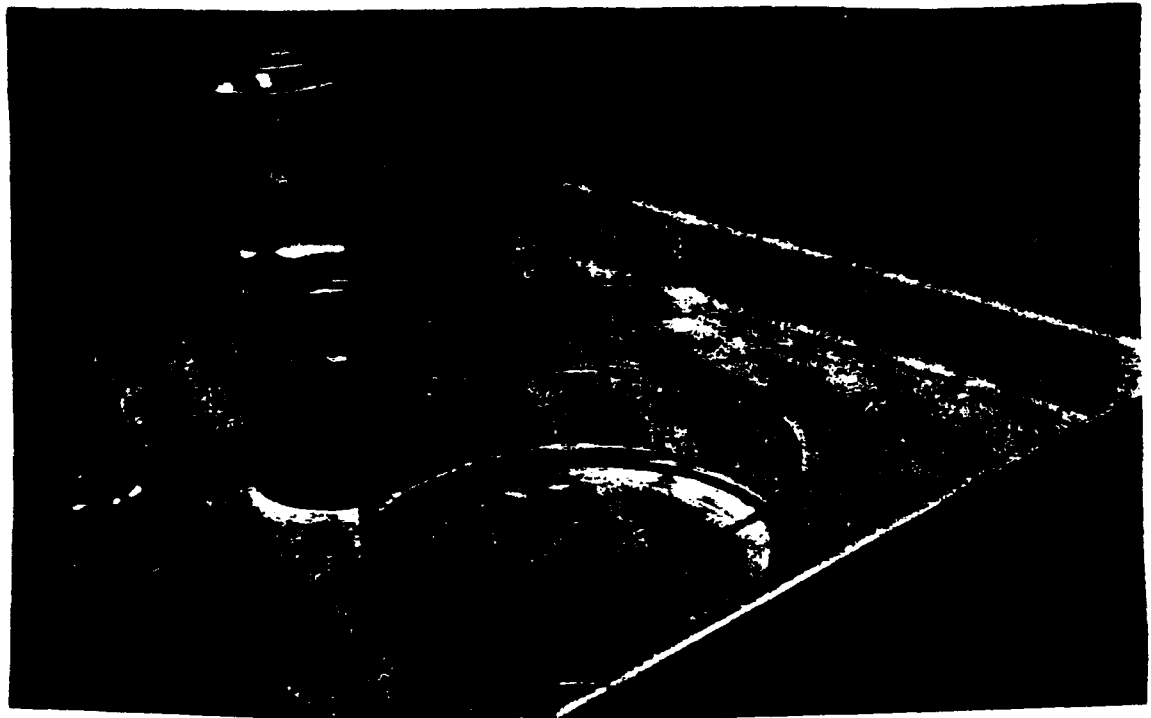

*Figure IV-2. Particle of WP after hitting the water surface. Most of the WP sinks and is extinguished. Some of the WP floats and continues to burn.*

particle of WP and dropped it into an empty jar. The particle was allowed to burn to completion on the glass surface of the bottom of the jar. When the residue had cooled, it was extracted with isooctane.

### Results

For the WP particle dropped into water, we found 9.4 mg of residual WP, or approximately 30% of the original mass. For the particle burned on a glass surface, we found 3.7 mg of unburned WP, or about 10% of the original mass.

### Discussion and Conclusions

Burning WP is extinguished when immersed in water, leaving a significant amount of unreacted material in the burn residue. Even when burned in air, some of the WP remains unreacted.

In experiments to identify the combustion products of WP-felt (WP impregnated in a felt matrix) munitions, Snelson (1980) reported between one part per million to one part per thousand by weight of the original WP remained unburned after test burns conducted at 50% relative humidity (Berkowitz et al. 1981). Spangford et al. (1985) measured the extent of conversion of WP to  $P_4O_{10}$  as a function of initial oxygen pressure using samples of WP-felt. They found that the upper limit of conversion was 92%, and they concluded that significant amounts of unreacted WP would remain unburned from WP-felt munitions.

The burned residue in both of our experiments was rusty-orange in color and flaky in appearance (Fig. IV-3). We have observed similar flakes in sediments from ERF; however, the particles of WP we isolated from sediments, as described below, were translucent yellow. These particles may have been the cores of burning pieces of WP that were extinguished upon entering the ponds of ERF, and with time, the oxidized material has dissolved. The white oxidized coating commonly found on WP stored under water will slowly dissolve in water (Russell 1903). When Russell heated the oxidized coating, a red residue formed, part of which was identified as red phosphorus (amorphous). Thus, the rusty-orange color we observed may be due to the formation of some red phosphorus that forms when WP is heated to 250–350°C (VanWazer 1958).



*Figure IV-3. Rusty-orange residue from burned WP in the laboratory.*

#### ISOLATION OF WP PARTICLES FROM ERF SEDIMENT

To characterize the WP particles in terms of their size and mass, seven WP-containing sediment samples collected in May 1991 from the Bread Truck Pond and Area C were examined.

##### **Methods**

Up to 30 mL of sediment was dispersed at a time with a Calgon solution (40 g/L of hexametaphosphate) and then rinsed through a 0.150-mm-mesh sieve. The material left on the sieve was placed in a petri dish with a calcium chloride solution to floc the suspended sediment and clarify the water. The material was then examined under a stereomicroscope. WP particles were recognized by their waxy, translucent-yellow appearance. White and pink particles were also isolated. When a WP particle was found, its dimensions were measured to the nearest 0.01 mm, the particle was photographed, and then it was dissolved in isooctane. The isooctane was analyzed by GC to

Table IV-2. Particles isolated from ERF sediments.

Sample number	Area	Conc. ( $\mu\text{g/g}$ )	Volume sieved (mL)	No. of particles isolated	Masses of particles (mg)	Lengths of particles (mm)
240	C	3.33	253	4	0.0049-3.4 median = 0.59	0.37-2.9 median = 0.96
248	BT	57.6	278	7	0.0001-0.75 median = 0.10	not measured
280	C	1.09	202	1	0.28	1.4
359	BT	33.7	295	12	0.0073-0.83 median = 0.13	0.29-1.4 median = 0.61
361	BT	10.6	383	26	<0.0001-2.3 median = 0.05	0.26-2.3 median = 0.89
228	C	0.001	343	0	--	--
224	C	0.0009	347	0	--	--

obtain an estimate of WP mass. Material that passed through the 0.150-mm sieve was dried in an aluminum pie pan.

### Results

Particles of WP were recovered from five of the seven sediment samples examined (Table IV-2). These samples all had WP concentrations greater than  $1 \mu\text{g/g}$  as determined by GC. The shapes of the particles varied considerably; some were angular while many were globular (Fig. IV-4). The particle masses ranged from less than  $0.1 \mu\text{g}$  to  $3.4 \text{ mg}$ , and the particle lengths ranged from 0.26 to 2.9 mm.

Particles were not recovered from the two samples with very low WP concentrations ( $0.001 \mu\text{g/g}$ ). However, when the dried material that had passed through the sieve was examined, small black specks were evident. We speculate that these specks are a result of WP oxidation to phosphorus pentoxide ( $\text{P}_4\text{O}_{10}$ ). Phosphorus pentoxide is extremely hygroscopic, and the



Figure IV-4. Particles of WP isolated from a sample (240) collected in Area C. Counterclockwise from the large particle to the left of the glass bead, the estimated masses are 3.4, 0.73, 0.045 and 0.0049 mg. The glass bead is 0.72 mm in diameter.

black specks are probably due to the wetting of the sediment surrounding each oxidized WP particle.

There is evidence that very small WP particles can be suspended in the water column (as colloidal particles) in Area C ponds. A 15-cm Wisconsin plankton tow net with a 76- $\mu\text{m}$  (0.076-mm) mesh size was dragged through the shallow pond just north of the Area C tower on 28–29 August. Walking through these ponds stirs up a fine suspension of the bottom sediments. Of two samples taken before this walking disturbance, one contained a very low but measurable concentration of WP (0.0008  $\mu\text{g/g}$ ). Another sample taken in the same place after disturbance of the bottom sediments yielded a concentration of 0.0224  $\mu\text{g/g}$ , suggesting that very small particles of WP are or may become suspended in the water column.

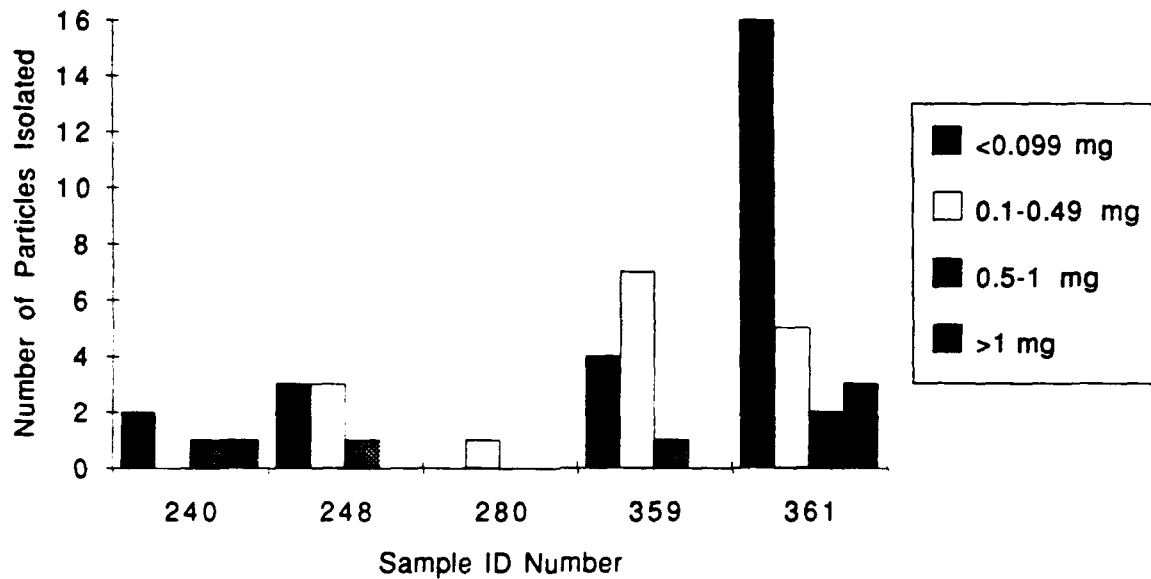

Figure IV-5. Ranges of masses of particles isolated from five ERF sediment samples.

### Discussion and Conclusions

The isolation and characterization of WP particles in sediments provide information on the dose of WP a duck receives from the ingestion of a single particle. Within a sediment sample, the masses of the particles isolated varied considerably (Table IV-2). For example, in sample 240, four particles were isolated, the largest of which was 3.4 mg and the smallest, 0.0049 mg (Fig. IV-5). Of the 50 particles isolated, most were less than 0.49 mg, and only four were greater than 1 mg.

Most of the particles isolated were greater than 0.5 mm in length (Fig. IV-6), and thus are in the size range of food items (Nudds and Bowlby 1984) or gizzard material selected by ducks. The smallest particles isolated were around 0.25 mm in length. However, if the black specks observed in the dried sieved material from the two low-level samples are in fact the result of oxidized WP particles, the size class containing particles less than 0.150 mm is significant.

The source of very small particles (on the order of a few microns) in the sediment samples and water column could have been the smoke clouds that formed when WP projectiles were deployed at ERF. Van Voris et al. (1987)

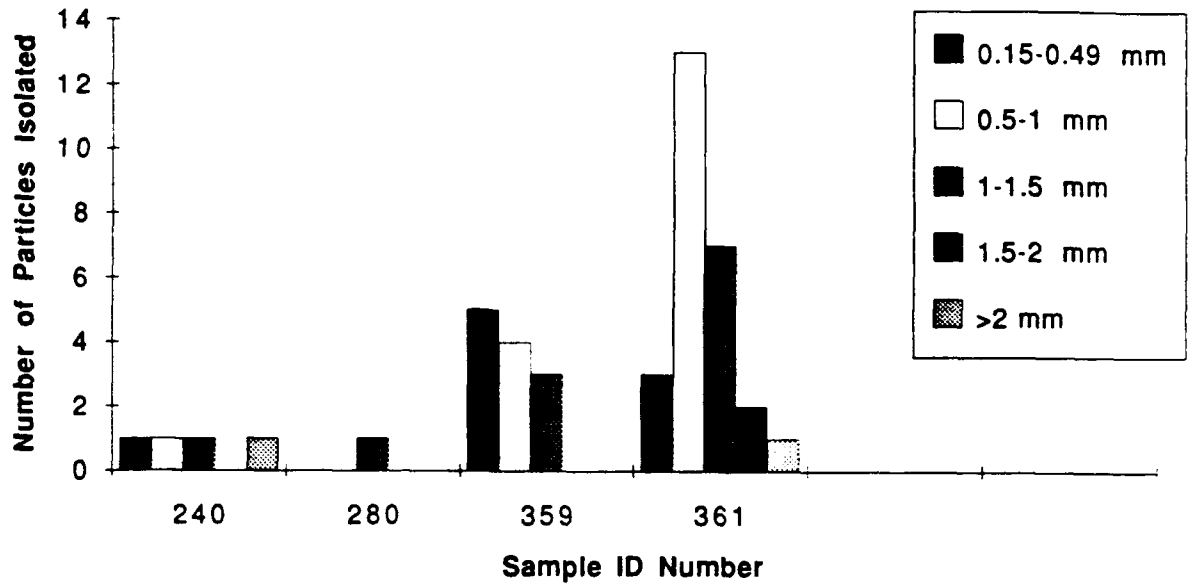

Figure IV-6. Ranges of lengths of particles isolated from ERF sediment samples.

measured chemical and physical characteristics of airborne smokes in relation to relative humidity and wind speed. Smoke clouds were generated by the controlled burning of WP in a combustion chamber, and the products were passed into a wind tunnel, where various measurements were made, including particle size and WP deposition. WP deposition onto a water surface averaged  $2.6 \mu\text{g}/\text{m}^2$  for clouds generated at 35-90% relative humidity over 1-4 hours. Particles (composed of WP, combustion products and water vapor) ranged in size from 0.3 to  $10 \mu\text{m}$ . The particle size distribution was log normal. The largest particles were produced during tests run at the highest relative humidity, as was expected since the particles grow by moisture accretion. To relate this information to the data we obtained for ERF sediments, we must first convert our data to a mass per area basis. For samples 228 and 224, approximately  $0.03 \mu\text{g}$  of WP was determined in a  $20\text{-cm}^3$  subsample. Assuming the top 5 cm of sediment was sampled in the field, the area sampled would cover  $0.0004 \text{m}^2$ . Thus, on a mass per unit area basis, we found  $75 \mu\text{g}/\text{m}^2$ . Considering that the WP in the ERF sediments is found at depth due to the accumulation of deposited WP over an unknown number of years, this estimate is in reasonable agreement with Van Voris et al. (1987). Thus, deposition from the smoke cloud may account for some of the very low

concentration samples we collected from ERF, and the particle size in these samples is probably on the order of microns.

Although the data are insufficient, samples with WP concentrations less than 1  $\mu\text{g/g}$  may not contain WP particles in a size range selected by ducks. However, other organisms may be affected. For example, at Pine Bluffs Arsenal, sediment concentrations above 0.002  $\mu\text{g/g}$  drastically altered the population of benthic organisms (Pearson et al. 1976). The finding of WP-poisoned phalaropes at ERF, which feed on zooplankton in the water of arctic ponds (Dodson and Egger 1980), also suggests that the water column may be a pathway of exposure to filter-feeding waterbirds in ERF.



## SECTION V. DISTRIBUTION AND CONCENTRATIONS OF WP IN ERF POND SEDIMENTS

### INTRODUCTION

Before any remediation efforts can begin in ERF, it is critical to know the location of the source of WP poisoning. Thus, a major objective of the 1991 field season was to determine the spatial extent and concentrations of WP contamination of ERF sediments in each of the waterfowl feeding pond areas. Shallow ponds cover about 50 ha (125 acres) of the 1000 ha ERF (Table I-1). Although dead waterfowl and WP-containing carcasses have been collected from ponds in all four areas (A, B, C and D), WP is not necessarily contained in the bottom sediments of all four areas; waterfowl may ingest WP in one area and fly into another pond where death takes place due to WP poisoning or predation. Because dabbling ducks that feed in the bottom sediments of ponds are the major victims, we assume that WP particles are located in the top 5–10 cm of bottom sediments where water depths are shallow enough (<25 cm) to allow the ducks to feed on the bottom by tipping up.

In May 1991 a sediment sampling program was initiated to systematically sample the bottom sediments of all the pond areas in ERF. By integrating the sediment sampling design with the waterfowl observation studies, it was also possible to identify areas where birds displayed early symptoms of WP poisoning and where sediment sampling should therefore be concentrated. Waterfowl observation blinds or towers 10–20 m tall were constructed by the Ft. Richardson DEH in the fall of 1990 and served as the center of waterfowl observations and the sediment sampling program during May and August 1991.

### METHODS

#### Transect Layout

Sediment samples were collected every 25 m along transect lines radiating from the observation towers near the centers of Areas A and C and from the

blind along the edge of Area D. Transect lines radiated in each of the compass directions (N, NE, E, SE, S, SW, W and NW). The lines ended at the edge of the ponds or on occasion extended into adjoining mudflats subjected to frequent flooding. The transect lines were marked every 50 m with 2-m-tall posts with numbered placards (Fig. I-3). The placards were marked with the compass direction and sequential numbers for the bearing and distance from the tower (for example, N-1 for the north transect 25 m from tower and E-3 for the sample point 125 m from the tower on the east transect). Sample sites at intermediate locations along the transect line were marked with 1.2-m-tall survey lath.

In August several "close-interval" samples were collected at a distance of 1-10 m from the 25-m-interval sample sites that tested positive for WP in May. In addition, several sediment cores were obtained (as described below) to determine the depth of WP contamination. The 25-m-interval was selected to adequately sample the pond areas in ERF. This interval should be of sufficient resolution to detect WP particles dispersed by an explosion, although the extent of ejecta generated by a detonation depends on a variety of factors, including height above the ground, projectile size and wind conditions; the imprint from such an event is probably on the order of 50-100 m.

#### Access

We used an Army UH-1H helicopter provided by Ft. Richardson to gain access to Areas A and B and the Bread Truck Pond. Access to Areas C and D and the C/D transition was mainly by foot or canoe from the east side of ERF. In all cases the sampling party was escorted by EOD personnel because of concern about unexploded ordnance or duds.

#### Sample Collection

At each sample point a surface sediment sample was scraped up with a rubber-glove-covered hand from beneath the water. The sample was packed into a 500-mL I-Chem jar to exclude all air and was tightly capped. At each sample point the water depth was recorded and the vegetation-habitat type and species noted. Two or more people made up the sampling party, including one person to collect the sample and another to hold the survey range pole and carry the sample jars.

### **Sediment Cores**

In August, several sediment cores were obtained to determine the depth of WP contamination. Coring soft bottom sediments is problematic. A coring device was designed and constructed at CRREL. It was made of clear 3-in.-diameter clear Plexiglas pipe. The non-coring end could be capped following insertion of the corer in the sediments. The vacuum provided by the cap permitted removal of an intact core. When the cap was removed, water that had been collected along with the sediments would pour out and then the sediment core was pushed out the end, cut into segments and placed in individual sample jars. Sediment cores were obtained from four sample sites in Area C and two in the Bread Truck Pond, both areas that had previously tested positive for WP.

### **WP Analysis in the Field Laboratory**

The filled sample jars were brought to the laboratory at the COE District soils lab for analysis within a few hours of collection. Several measurements were made as described below and a 20-cm<sup>3</sup> core was taken out of each jar with a cut-off syringe. This core was placed in a preweighed jar containing iso-octane solvent and additional water (as described in Section III), reweighed and placed on a mechanical shaker overnight. In the morning an aliquot of the iso-octane above each sample was placed in a vial and then injected into the GC. The WP mass from the 20-cm<sup>3</sup> sample was calculated and the concentration expressed as the weight of WP per unit weight of the wet sediment.

### **Measurement of Environmental Parameters**

Salinity, pH, redox potential and temperatures were obtained for about half the samples collected during the 1991 field season. In May, salinity and redox potential were measured in the laboratory within a few hours of collection. The measurements were therefore made on the pore water in the sediment sample jars collected from the beginning, middle and end of each transect. At this time the salinity of the pore water was measured using a Hach digital titrator (mercuric nitrate titration method of chloride analysis). The redox potential was measured with a Hach One pH meter (in mV mode equipped) with an oxidation-reduction (ORP) electrode embedded in the sediment sample jar. During August a YSI Salinity-Temperature and Conductivity meter was used in the field to determine the salinity, temperature and

conductivity of the water column overlying each sediment collection site. The redox potential was again determined in the laboratory using the same method as that used in May.

### Surveying

Each sample site was surveyed using an electronic Leitz SET4 Total Station (a theodolite with a built-in laser distance measure device) and a range pole with a three-prism reflector. The Leitz Total Station provides a direct digital readout of horizontal and vertical angles, as well as horizontal and vertical distances between the instrument and the prism being sighted on.

Three permanent survey control points, with known coordinates and elevations, were established prior to 1991 on high points around the perimeter of ERF (Fig. I-2). "Ruth" is located on the bluff overlooking Area D near the northeast edge of the flats. "Point Cole" is located on the southwest side overlooking Area B. "Tank" is at the observation point overlooking the EOD pad and Area C. A fourth control point, "Point Crane," surveyed and established in 1990, is on the edge of the EOD pad, immediately adjacent to Area C. During 1991, additional survey control points were established to provide survey control during the detailed sampling in the shallow ponds in Areas A, B, C and D. Locations of each of the towers and the blind were precisely surveyed from the known control points. Points were marked on the center of the upper decks of the towers and surveyed in. The UTM coordinates and the elevations for each of these survey points were computed. These new control points were then used to provide horizontal and elevation control when sample locations in the vicinity were surveyed.

Almost all the sampling areas were visible from at least one of the original control points or one of the newly established tower control points. The survey point for Area A was the top of the observation tower in A; the survey point for Area C was either Pt. Crane or the observation tower in C; for Area B the tower at Cole Point was used; the surveyed point for Bread Truck Pond was the observation tower in C; Area D was surveyed from the blind in D.

The three-prism reflector on the range pole was placed over each sample point, and the horizontal angle and horizontal and vertical distances from the Leitz Total Station to the sample point were determined. Based on the horizontal azimuth and distance from the control point, a set of UTM coordinates for the sample point could be calculated. Horizontal accuracies are on

the order of  $\pm 0.01$  m. Elevations of the sample points were calculated based on the vertical distance directly measured between the instrument and the prism, the height of the instrument above the control point, and the height of the prism above the ground. The UTM coordinates and elevations are provided for each sample point in the Appendices to this report.

Small ponds north and south of the main pond in Area A and a pond on the west side of Area D were not directly surveyed, either because of the distance to the nearest control point or because there were not enough people to do both the sampling and the surveying. In these cases sampling points were located on large-scale color IR aerial photographs while the sampling party was in the field. UTM coordinates for the sample points were later scaled from known, surveyed locations on these photographs. The accuracy of plotting sampling points on the photographs was quite good. The detail and clarity of the photography allowed the plotting of locations on the photo to within an estimated  $\pm 2$  m. The accuracy of scaling the UTM coordinates from known locations on the map adds an additional estimated error of  $\pm 2$  m for a total estimated positional error of  $\pm 4$  m.

#### **Preparation of Detailed Maps**

The calculation of UTM coordinates for the sample sites, observation blinds and other features, visible on a set of color infrared aerial photos (obtained on 21 July 1991), permitted the precise mapping of WP contamination and sample sites in relation to the habitat-vegetation zones, distributaries, craters, waterfowl carcasses and other features. The resulting maps showing the distribution of WP contamination provide important information for remediation work. These maps were prepared by positioning a 100-m-interval UTM grid transparency over the photo of each area and mapping the various habitat types, distributaries and sample sites or transects onto these transparencies.

## **RESULTS**

#### **Presence of WP**

Of 388 sediment samples collected in all six ponded areas of ERF during 1991 (Appendix C), 116, or 30%, tested positive for WP. Over 65% of the sam-

ples collected in the Bread Truck Pond were positive, compared with 40% in Area C (Table V-1, Fig. V-1). None of the samples collected in Areas B or D showed detectable levels of WP. In Area A, about 12% of the samples (12 out of 94) were positive for WP, compared with 9% (2 out of 23 samples) of the samples in the C/D transition area. As emphasized in Section III the level of confidence in the WP presence or absence results is high.

*Table V-1. Results of WP analyses of sediment samples collected in Eagle River Flats at 25-m intervals and at closer intervals (1-10m) along transects during May and August 1991.*

Feeding area	Date collected	Number of samples	Positive for WP		Concentration range ( $\mu\text{g/g}$ )
			Number	Percentage	
A	May-91 (25 m)	51	8	16	0.0001-0.06
	Aug-91 (25 m)	43	5	7	0.0004-0.05
	Total (25 m)	94	11	12	
	Close Interval	9	4	44	0.0004-0.05
B	May-91 (25 m)	0	0	0	--
	Aug-91 (25 m)	15	0	0	--
C	May-91 (25 m)	86	36	42	0.0002-6.3
	Aug-91 (25 m)	38	13	34	0.0004-1.1
	Total (25 m)	124	49	40	
	Cores (4)	14	12	86	0.0035-197.9
	Before explosion test	18	12	67	0.001-4.8
	After explosion test	11	11	100	0.009-49.7
C/D	May-91 (25 m)	0			--
	Aug-91 (25 m)	23	2	9	0.001-0.01
D	May-91 (25 m)	16	0	0	--
	Aug-91 (25 m)	27	0	0	--
	Total	43	0	0	
Bread Truck	May-91	23	16	70	0.0004-57.6
	Aug-91	20	13	65	0.003-7.7
	Total	43	29	68	
	Close interval	4	4	100	
	Cores (2)	6	5	83	0.0014-7.72
Pond Beyond	May-91 (25 m)	7	1	14	0.02
	Aug-91 (25 m)	0	0		--

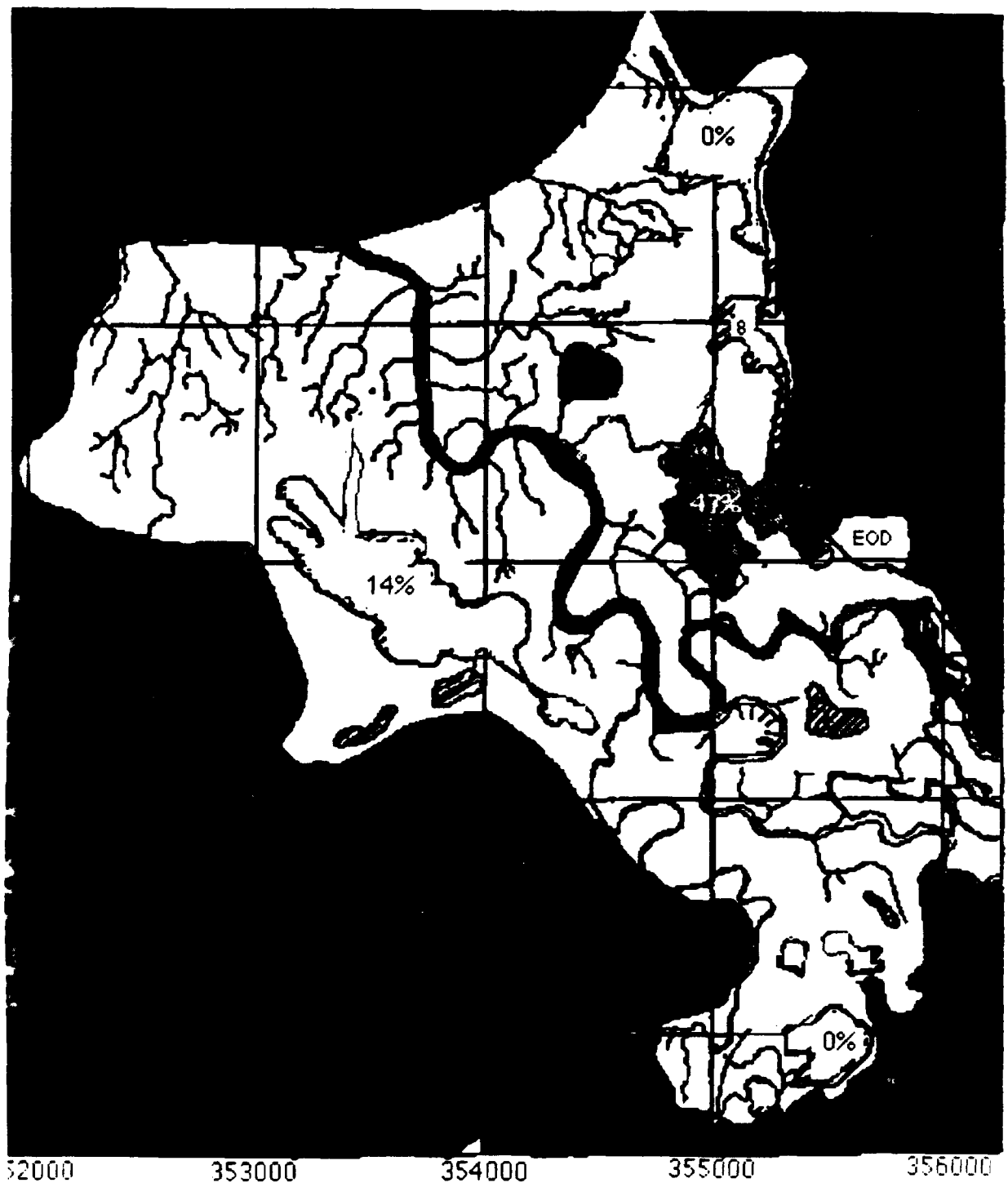

Figure V-1. Map of Eagle River Flats showing the Eagle River and its distributaries and the percentage of sediment samples that tested positive for WP in each of the six waterfowl feeding areas. The UTM grid lines are 1000 m apart.

### Concentrations and Mass of WP

In the sediment samples testing positive for WP, concentrations of WP were highly variable, both between and within samples from the ponded areas. Because of the variability due to subsampling error for particulates, described in Section III, the concentration and mass values are considered less reliable than the presence and absence data. Concentrations ranged from less than certified reporting limits of 0.004  $\mu\text{g/g}$  up to 57.6  $\mu\text{g/g}$ , with most values less than 0.099  $\mu\text{g/g}$  (Table V-1, Fig. V2a). However, when the frequency distribution of concentration and mass is plotted on a log scale, the values are normally distributed (Fig. V-2a). The masses in the 20-cm<sup>3</sup> subsamples are included here (Fig. V-2b) because WP is in a particulate form, and mass per volume of sediment is more relevant to waterfowl feeding behavior. WP mass values varied from 0.001  $\mu\text{g}$  up to 2 mg (2000  $\mu\text{g}$ ), with most less than 1  $\mu\text{g}$  per 20-cm<sup>3</sup> sample. This mass (1  $\mu\text{g}$  or less) could be produced by a single small particle in the 20-cm<sup>3</sup> subsample. Table V-2 presents the mean WP concentrations and masses for 20-cm<sup>3</sup> subsamples of the positive samples from ERF. Each area is discussed separately below.

### Distribution in Feeding Ponds

#### *Area A*

Area A is the largest waterfowl feeding pond area (over 15 ha of open water) (Fig. V-3). There are at least six or seven target vehicles with associated craters on the mudflats east of the feeding ponds. Only a limited number of samples (12 out of 94, or 12%) tested positive for WP (Table V-1), and these were all located in the main pond area to the south and east of the tower (Fig. V-3). Only one sample from north of the tower tested positive. No samples from the outlying ponds to the northwest and southeast of the main pond were found to contain WP.

The mean WP concentration (0.014  $\mu\text{g/g}$ ) from the 12 positives from Area A was relatively low compared with the other areas (Table V-2). The sample with the highest WP concentration in Area A (333, with 0.062  $\mu\text{g/g}$ ) was collected on the mudflat, which was unflooded on 28 May. Close-interval samples collected 1 m north, south, east and west of this sample site all tested negative. However, four out of five samples collected around sample 336 below water in the bulrush pond just southeast of the tower tested positive for WP.



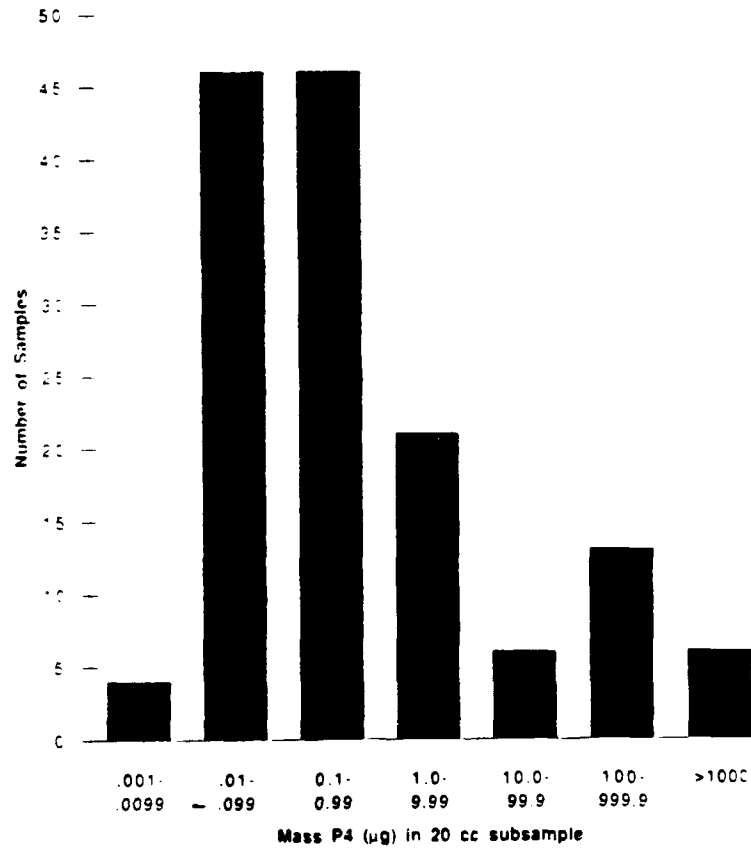
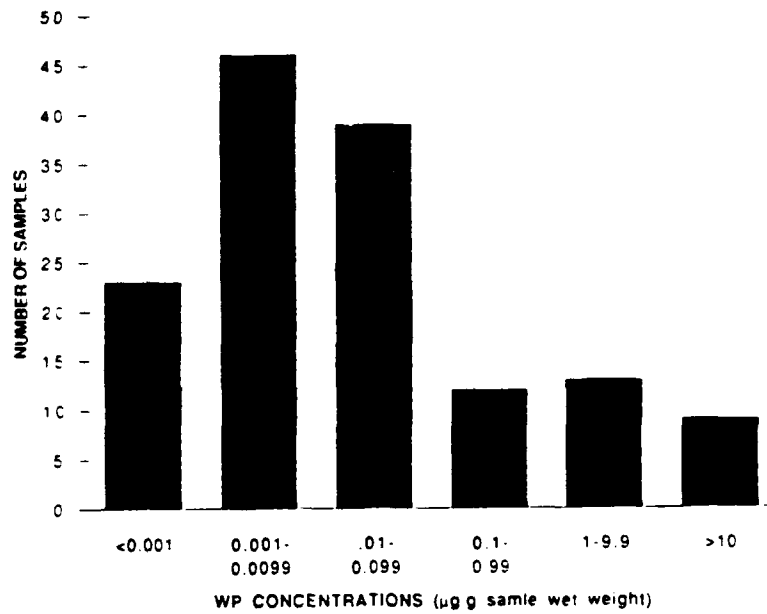

Figure V-2. Number of sediment samples, from all six waterfowl feeding areas of Eagle River Flats, in each of several a) concentration or b) mass ranges. Only those samples testing positive for WP are included.

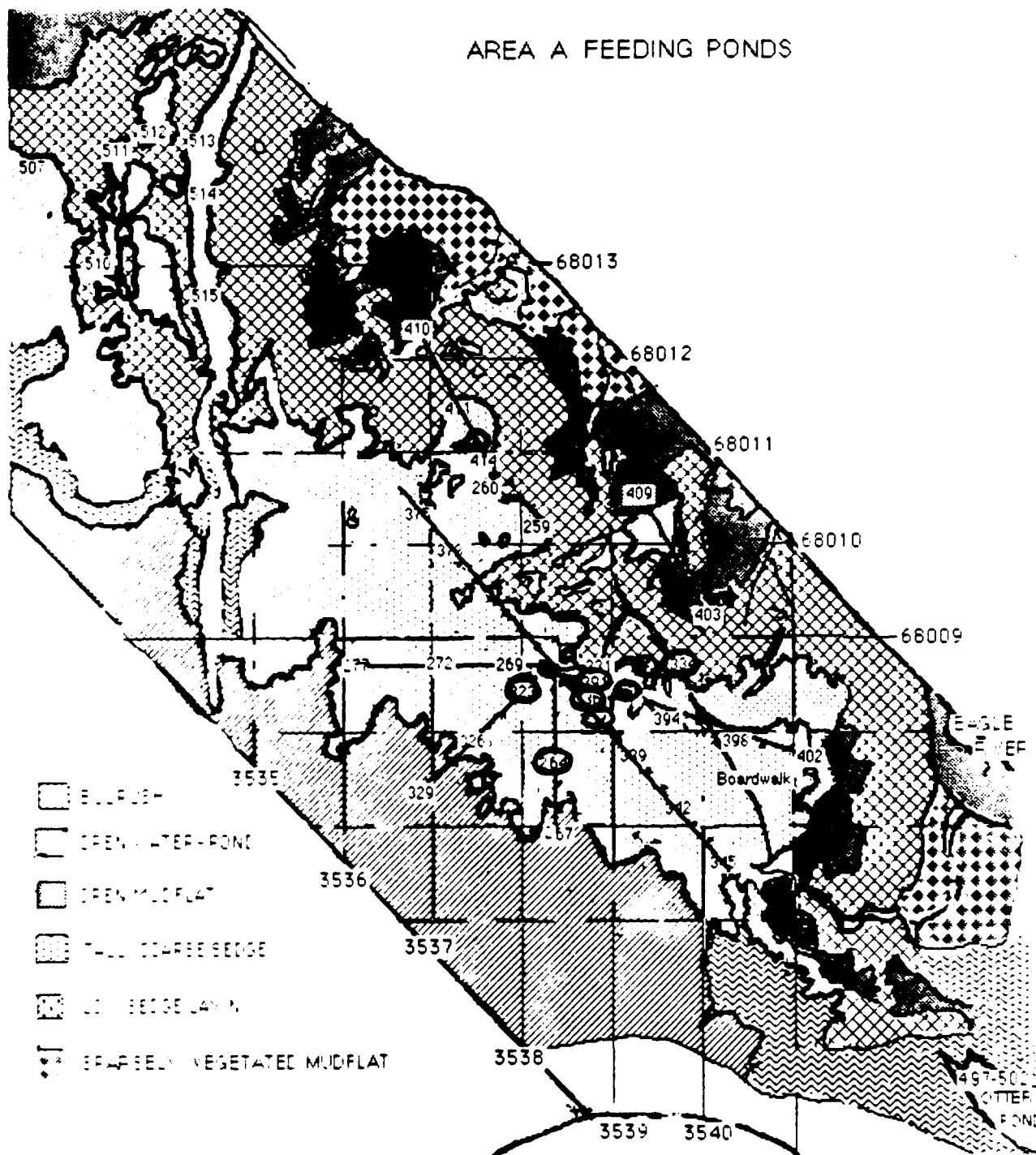

Figure V-3. Vegetation-habitat map of Area A on the west side of ERF showing the location of sediment sample sites by numbers and/or transect lines. (Not all numbers are shown along the transects). Samples that tested positive for white phosphorus are circled. This area is not highly contaminated relative to Area C and the Bread Truck Pond. Two connected ponded areas to the northwest and southeast (Otter Pond) were also sampled. The UTM grid lines are 100 m apart.

*Area B*

Area B is in the extreme southwest corner of ERF and consists of a large number of fairly deep (0.1–0.5 m) small ponds and pools surrounded by lush, tall bulrush and coarse sedge vegetation. Since this area is in the buffer zone of the impact area, there are few craters and no targets, but dead waterfowl have been found here in the past. Salinities of the water were less than 4 ppt, and reuox potentials averaged about  $-300$  mV, as expected of the highly organic black sediments collected here. None of the 15 sediment samples collected from a wide range of ponds and pools tested positive for WP.

*Area C*

Area C includes a large and diverse complex of deep ponds and inlets (Clunie Creek) with tall bulrush and sedge vegetation along the upland (inner) edge of ERF that grades west out toward Eagle River into a shallow pond and mudflat (Fig. V-4), where there are abundant craters and several targets. Of the 123 samples collected here, 49, or 40%, contained WP. Most of the positive samples are located in the northern half of the pond. There are four major areas of contamination in Area C:

- A large area about  $300 \times 200$  m along the northern side of the pond;
- A bulrush area in the northeast part of the pond, which is highly contaminated, as are the deeper waters near the Clunie Creek inlet;
- The area around the tower and extending east to the shore and small inlet; and
- The mudflat area to the west and southwest of the tower, where at least four samples contained low levels of WP.

The mean concentration of WP in the positive samples from Area A was  $0.291$   $\mu\text{g/g}$  (Table V-2), which is significantly lower ( $p = 0.05$ ) (using a non-parametric Mann-Whitney U test) than the mean concentration ( $3.70$   $\mu\text{g/g}$ ) of positive samples from the Bread Truck Pond (Fig. V-5). The highest WP surface concentrations in Area C were found along the transect running northwest from the tower. However,  $20\text{-cm}^3$  subsamples from a sediment core at the end of the east transect near the shore contained WP masses of  $3700$  and  $5500$   $\mu\text{g}$  (the highest of any samples collected in 1991). The four core samples obtained in Area C all showed that WP contamination extended to depths greater than  $10$  cm, and in some cases concentrations were greater at depth than nearer the surface (Table V-3).

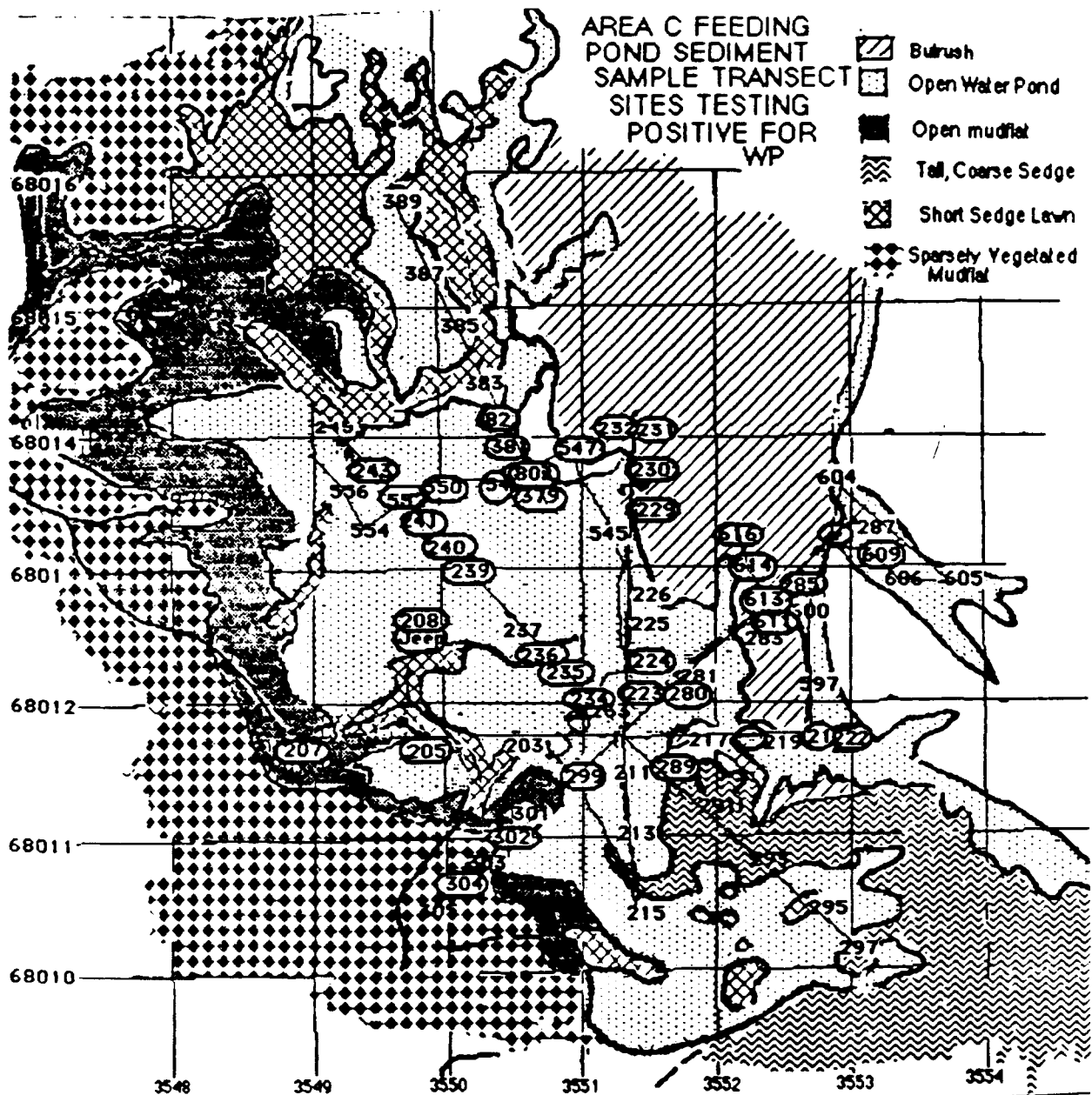

Figure V-4. Vegetation-habitat map of Area C waterfowl feeding pond area showing the locations of sediment sample numbers along transects lines. The sediment samples testing positive for white phosphorus are circled. The sediments of this pond area are highly contaminated with WP. This semipermanent pond is located on the east side of ERF and grades from deeper water along the shore to shallow water on the mudflat or outer edge. The UTM grid lines are 100 m apart.

Table V-2. Means and standard deviations for concentrations and mass (in 20-cm<sup>3</sup> subsamples) for white phosphorus in the sediment samples testing positive from the bottom of three feeding pond areas.

Area	No. testing positive	Geo. mean	Mean concentration (SD)		Mean mass (SD)	
			µg/g	Log	per 20 cm <sup>3</sup>	Log
Bread Truck	29	0.025	3.70 (12.2)	-1.60 (1.48)	115 (401)	-0.111 (1.47)
C	49	0.006	0.29 (1.03)	-2.25 (1.15)	7.67 (24.6)	-0.759 (1.13)
A	12	0.003	0.014 (0.02)	-2.48 (0.90)	0.473 (0.657)	-0.985 (0.912)
All areas	98	0.009	1.31 (6.97)	-2.07 (1.26)	40.1(228)	-0.582 (1.24)

Mann-Whitney U: (p = 0.05) BT/C Conc.

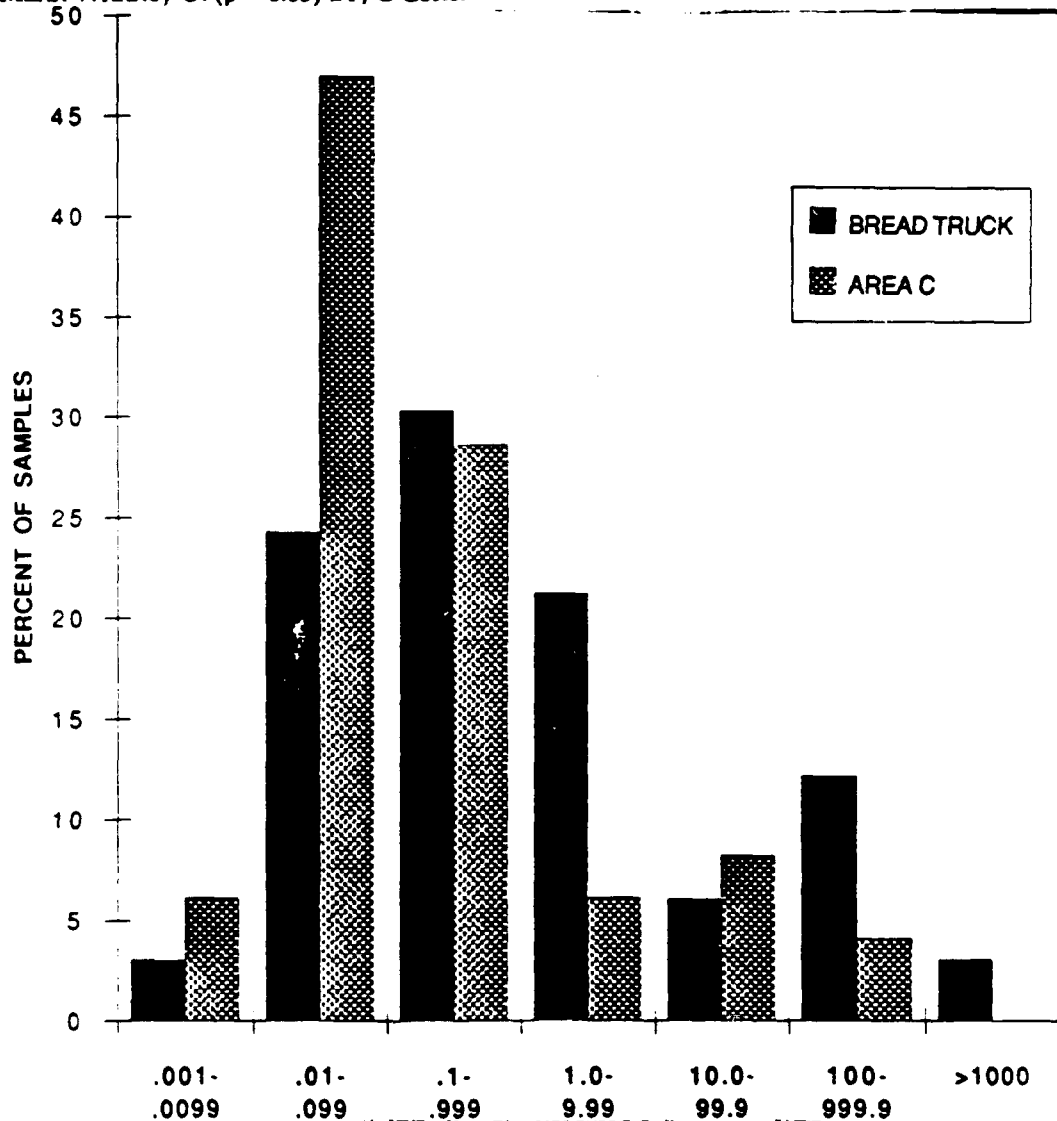

Figure V-5. Percentage of positive-WP sediment samples from the Bread Truck and Area C ponds in each mass range.

Table V-3. WP analysis of sediment cores from Area C and the Bread Truck Pond obtained in August 1991.

Sample number	Depth increment	Sample size (g)	WP mass ( $\mu\text{g}$ )	WP conc. ( $\mu\text{g/g}$ )	Water depth (cm)
<i>Area C</i>					
617	at 221 (E+150m) (0-7 cm)	25.6	0.253	0.0099	
618	7-14 cm	36.0	0.128	0.0035	
619	14-24 cm	35.3	0	0	
620	24-28 cm	23.9	0	0	
540	3-7 cm	20.7	3700	179	
541	7-11 cm	12.0	1.55	0.129	
542	11-13 cm	27.9	5520	198	
558	at 240, 0-3 cm	19.0	0.912	0.0480	35
559	3-6 cm	28.4	104	3.66	35
560	6-10 cm	39.0	118	3.02	35
561	10-17 cm	28.0	161	5.78	35
569	core 235, 0-5 cm	35.3	2100	59.5	
570	core 5-13 cm	21.7	0.738	0.0340	
<i>Bread Truck Pond</i>					
528	at 248, 0-3 cm	23.9	185	7.72	9
529	3-6 cm	30.3	0.0468	0.0015	9
530	6-10 cm	52.9	0	0	9
535	core at 248, 0-3 cm	44.3	0.191	0.0043	
536	3-6 cm	45.8	0.0120	0.0003	
537	6-9 cm	27.6	0.0384	0.0014	

#### *Area C/D Transition*

This small permanent pond area along the east side of ERJ is a complex area of deeper narrow ponds and channels where beavers are active (Fig. V-6). The bulrush and sedge vegetation surrounding these channels and ponds is very productive and over 2 m tall, affording concealment for waterfowl. Water depths are generally greater than 0.4 m, suggesting that feeding by dabbling ducks here is limited. The bottom sediments are black organics with very low redox potentials ( $-300$  mV). The salinities of the pond water are less than 4

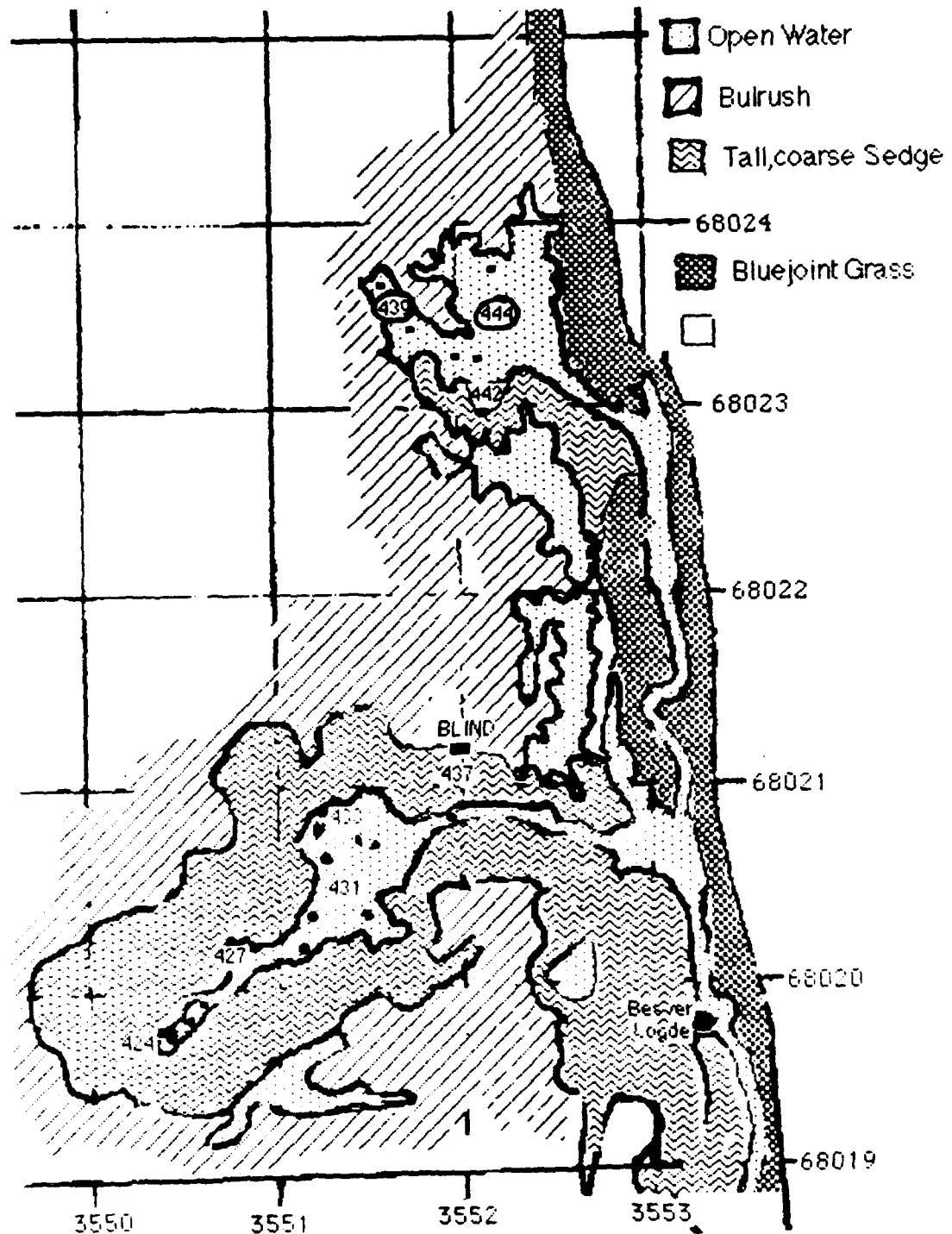

Figure V-6. Map of Area C/D on the east edge of ERF between Areas C and D, where there is beaver activity and tall bulrush and sedge marsh surrounding two small, deep pond areas. The locations of sediment samples are shown by black dots, with sample numbers provided for a few of these dots. The two samples testing positive for WP are circled. The UTM grid lines are 100 m apart.

ppt. Two pond areas were sampled (Fig. V-6). Thirteen samples at the bottom of the largest pond all tested negative for WP. However, two out of nine samples from a smaller pond area to the north contained low levels of WP (0.001 and 0.012  $\mu\text{g/g}$ ).

#### *Area D*

Area D consists of a fairly deep (0.3–0.5 m) permanent pond in an embayment in the northeast corner of ERF (Fig. V-7). Small islands and patches of bulrushes are scattered throughout the pond. To the northwest the pond grades into shallow ponds, mudflats and distributary streams out toward Knik Arm. Salinities here were about 7 ppt, and redox potentials were extremely low (–300 to –500 mV) in the highly organic black bottom muck. Although the 43 samples collected in Area D represented both the deeper pond and the shallow ponds to the west, none of the samples were positive for WP. This area is in the buffer zone of the impact area, and there are few craters.

#### *Bread Truck Pond*

This 5-ha semipermanent pond is located near Eagle River, about 500 m west of Area C/D and 200 m northwest of Area C. Craters are dense on the west side of the pond, and there are several target vehicles (including the yellow panel truck for which we named the pond). Water depths vary from 1 cm along the mudflats near Eagle River to 30 cm along the east side of the pond, where it grades into the vast bulrush area on the east side of ERF (Fig. II-1). Redox potentials here were always between –250 and –350 mV, with higher salinities (10–20 ppt) than in the other ponds sampled.

The Bread Truck Pond (Fig. V-8) was not originally recognized as an area of waterfowl feeding and mortality, but it was identified as a site of high mortality and predation in the spring of 1991 by our avian ecologists making observations from the tower in Area C. At their recommendation, we initially collected sediment samples at 25-m intervals along a north–south transect across this pond (Fig. V-8), with 10 of the 11 samples collected along this transect running south from the yellow panel truck testing positive for WP; one of these samples contained the highest level of WP found to date in surface sediment samples at ERF (57.6  $\mu\text{g/g}$ , or 2 mg/20  $\text{cm}^3$ ).

The mean concentration and mass of WP in the surface sediment samples testing positive from the Bread Truck Pond (3.70  $\mu\text{g/g}$  and 115  $\mu\text{g}$ ) (Table V-3,



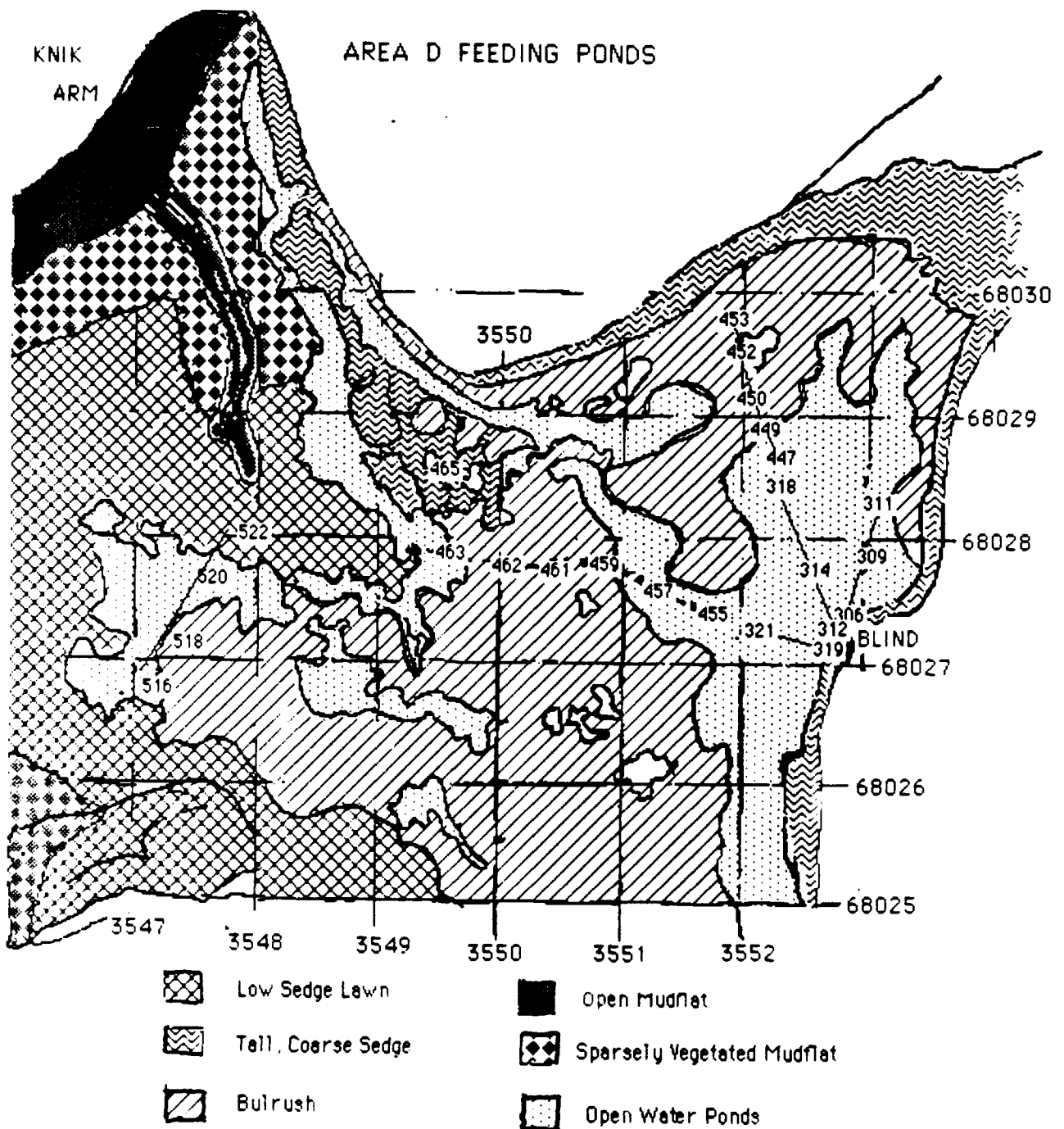

Figure V-7. Map of Area D permanent pond in the northeast corner of ERF, showing the distribution of sediment sample transect lines and points in relation to the various types of habitat. The main pond here is fairly deep (40 cm) and surrounded by bulrush marsh. A gull nesting area is also located here. Not all sample numbers are shown, and none of the 43 samples collected here tested positive for WP. The UTM grid lines are 100 m apart.

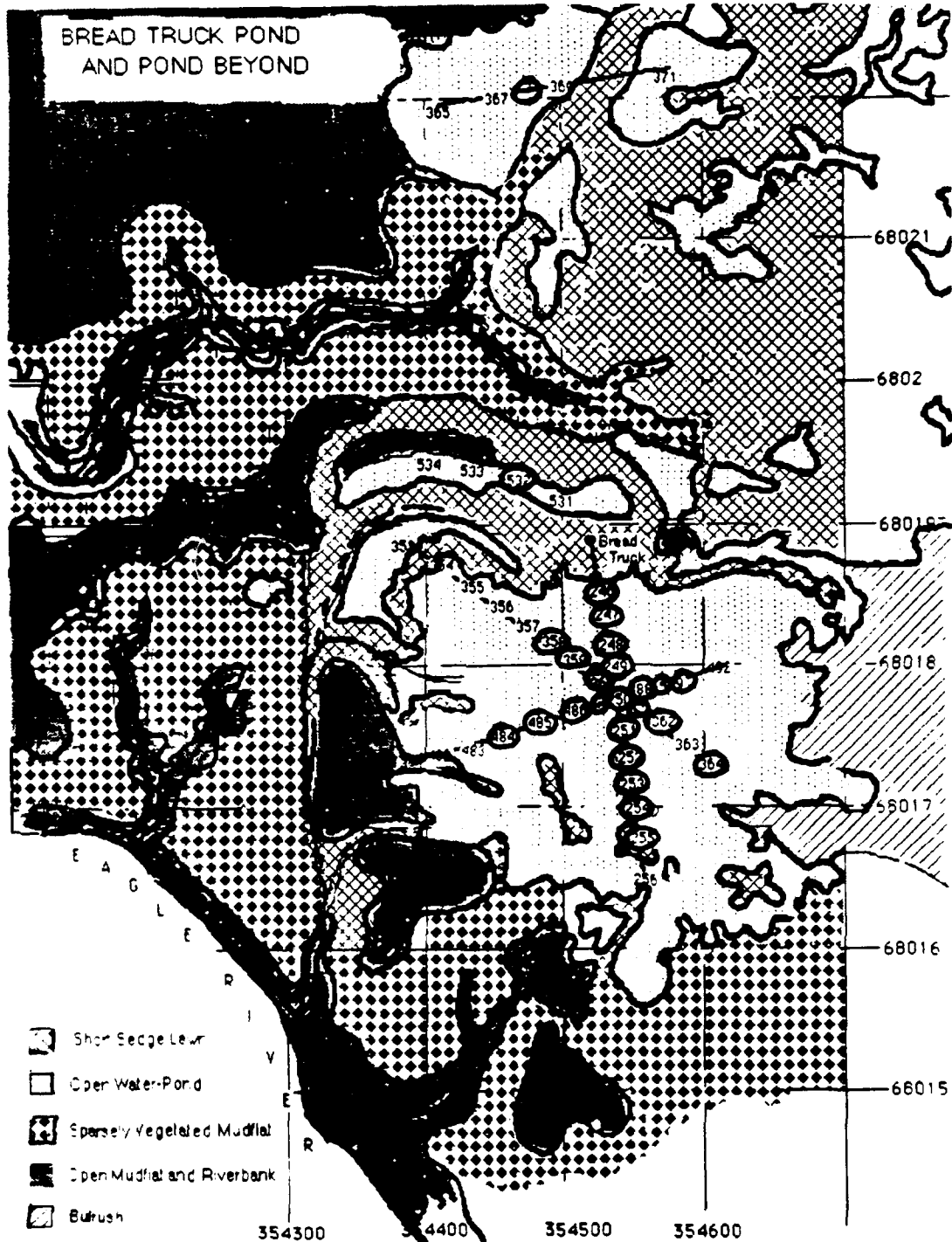

Figure V-8. Map of the Bread Truck Pond (center) and Pond Beyond (top of map) near the east bank of the Eagle River. The Bread Truck semipermanent pond was found to have the most highly WP-contaminated sediments of the six ponded areas. The pond is bordered by mudflats along the outer (or river) side and bulrush marsh along the inner side.

Fig. V-5) were significantly higher (using non-parametric tests on the mean and parametric tests on the mean log) than those in either Area C or Area A.

The main area of contamination and highest WP concentrations is near the center of the pond in 8–10 cm of water (Fig. V-8). Additional close-interval samples collected in the center of this pond were all positive, with high concentrations of WP. Two sediment cores collected near the pond's center showed that WP was present to depths of at least 10 cm in the sediments (Table V-3), although the levels here were lower than in the cores from Area C.

#### *Pond Beyond*

Several sediment samples were collected in a nearby shallowly flooded mudflat pond about 200 m north of the Bread Truck Pond (called here the Pond Beyond) (Fig. V-8). There are a target truck and abundant craters on the west edge of this pond. Seven samples were collected here, with one of these samples testing positive at a concentration of 0.022 µg/g.

## DISCUSSION

Both the high percentage of positive samples and the relatively high concentrations of WP found in Area C and the Bread Truck Pond strongly suggest that these two areas (15 ha, or 37 acres) may be a major source of waterfowl poisoning in Eagle River Flats. A starting point for remediation should be treatment of the sediments or exclusion of waterfowl feeding in the center of the Bread Truck Pond. However, our sediment sampling was confined to the bottoms of the major waterfowl feeding ponds representing an area less than 5% of Eagle River Flats. The other areas of ERF representing 95% of ERF should not be labeled as "uncontaminated." WP probably occurs elsewhere in the flats, particularly in wet mudflat sediments, which may in the future become ponded and used as feeding areas for dabbling ducks.

Despite the uncertainties at both large and small sampling scales and the subsampling error described in Section III, we think that we have identified the important hot spots in relation to the five major ponded areas where the bulk of migrating ducks feed.

The majority of sediment samples that tested positive for WP have very low concentrations or mass of WP, and although ingestion of a large number of very small particles could poison a duck, a 1- $\mu$ g particle about 0.082 mm in diameter is smaller than food items usually selected (Nudds and Bowlby 1984). Contaminated sediments probably contain many small particles and a very few large WP particles so that when a duck processes large amounts of contaminated sediments, the ingestion of a large particle is likely.

Although WP was found in a limited number of sediment samples in Area A, the concentrations or extent of contamination did not seem sufficient to be a major source of poisoning. Area C/D also contained two sediment samples with low levels of WP, and virtually no craters are located near this ponded area. One non-munition source of indirect WP contamination may be the decomposition of a WP-poisoned duck that ingested WP in the Bread Truck Pond or Area C and flew into the nearby sheltered Area C/D to die. A preliminary study of WP fate in decomposing carcasses conducted during 1991 showed that WP persisted in rotting carcasses and could therefore be redeposited in the sediments (Table VI-4).

The mechanisms by which an exploding WP smoke round deposits unburned WP particles into the sediments is not known but might include airburst residues, ground burst ejecta, delayed detonation deep within the sediments, leakage from WP-containing duds and low-level redistribution by ducks themselves when contaminated carcasses rot and are incorporated into the sediments. Both Area C and the Bread Truck Pond have high crater densities and a number of target vehicles on the mudflat (river) side. This fact, coupled with the observation that positive samples tend to be clustered in three to five successive 25-m-interval sample sites along a transect, suggests that WP is derived from airburst residues and/or ground burst ejecta. Targeting errors probably explain the contamination of bulrush areas along the east (landward) side of Area C.

There was no clear relationship between the distribution of WP in the bottom sediments and the redox potential, salinity or pH of the sediments. However, all the sediments in Eagle River Flats are highly reduced with a redox potential in the -150- to -400-mV range. WP, once deposited in these anaerobic sediments, would be protected from oxidation.

## SECTION VI. WATERFOWL MOVEMENT AND POSSIBLE TRANSPORT OF WP

### INTRODUCTION

Following the initial ingestion of WP by a dabbling duck in a particular pond on ERF, the bird may be capable of flying to another area on ERF or out of ERF to another area of Cook Inlet. Such ingestion followed by flight would result in the transport or movement of WP and could pose a health hazard to hunters in other areas of Cook Inlet. The objectives of this section are to present information on the ability of poisoned waterfowl to move within or out of ERF and to determine movement patterns of ducks within ERF.

The ability of birds to fly following ingestion probably depends on the size or mass (dose) of the particle ingested and the rate of absorption of the WP. The analysis of WP particle sizes and masses in the sediments described earlier in this report and the finding of a large number of sediment samples with low WP concentrations ( $<1 \mu\text{g}$ ) suggest that there are abundant opportunities for exposure to sublethal doses of WP. No toxicological studies of sublethal or chronic, long-term effects of WP on waterfowl were conducted, although Coburn et al. (1950) gave two mallards and two black ducks doses of 1 mg/kg at irregular intervals over two weeks or until death. Both of the black ducks survived for two weeks, while one of the mallards died within three days and the other survived for 18 days.

A 1969 spill of water containing colloidal and dissolved white phosphorus (phosphy water) into a marine bay at a Newfoundland WP-manufacturing plant resulted in a massive die-off of fish around the plant as well as the death of herring (*Clupea harengus*) and other fishes as far as 80 km from the manufacturing plant (Idler 1969). Schools of fish, especially herring, swam through the relatively small plume of "phosphy water" and died many kilometers from the source.

To understand the possible transport of WP within or out of ERF, several studies were conducted during the 1991 field season:

- Collection of tissues and dead waterfowl from Cook Inlet ponds and marshes outside ERF;

- Collection of flying (apparently healthy) waterfowl in ERF;
- Monitoring of waterfowl movement patterns within and outside ERF by human observations, by trapping and banding, and by radiotelemetry.

## METHODS

### Collection of Dead Waterfowl Outside ERF

#### *Lake Surveys*

Four small lakes surround ERF: Gwen, Clunie, Waldon and Otter lakes (Fig. VI-1). In 1991 all four of these lakes were searched by canoe on a weekly basis in June and on a bi-weekly basis in July through September to see if any waterfowl died on nearby lakes from WP poisoning.

In 1988 the military police found and collected a dead mallard in Gwen Lake. Our subsequent analysis of the gizzard contents of this mallard showed the presence of WP (Table VI-1). On 14 June the remains of a red-necked grebe (*Podiceps grisegena*) were found on Clunie Lake. The carcass of a common loon (*Gavia immer*) chick, less than one week old, was discovered in Otter Lake on 9 July, and on 14 August a dead red-necked grebe chick was picked up from Gwen Lake. Skin samples were taken, and no WP was present in the loon or the grebes. On 26 August a carcass of a green-winged teal was found in the road bordering the southeast side of ERF. High levels of WP (>1 mg) were found in the gizzard and tissues of this individual.

#### *Upper Cook Inlet Marsh Surveys and Collections*

Goose Bay and Fire Creek salt marshes (Fig. I-1) were searched by helicopter on a monthly basis from May through August 1991. No carcasses were found in Goose Bay or Fire Creek, but carcasses in emergent cover are very difficult to see in aerial searches and may be overlooked.

During the first week of the 1991 Cook Inlet waterfowl hunting season, over 300 gizzards and skin samples were collected from hunter-harvested ducks at Goose Bay, Palmer Hay Flats, Susitna Flats and the Anchorage Wildlife Refuge by the Alaska Dept. of Fish and Game and by USFWS (see Section IX). WP was not detected in any bird.

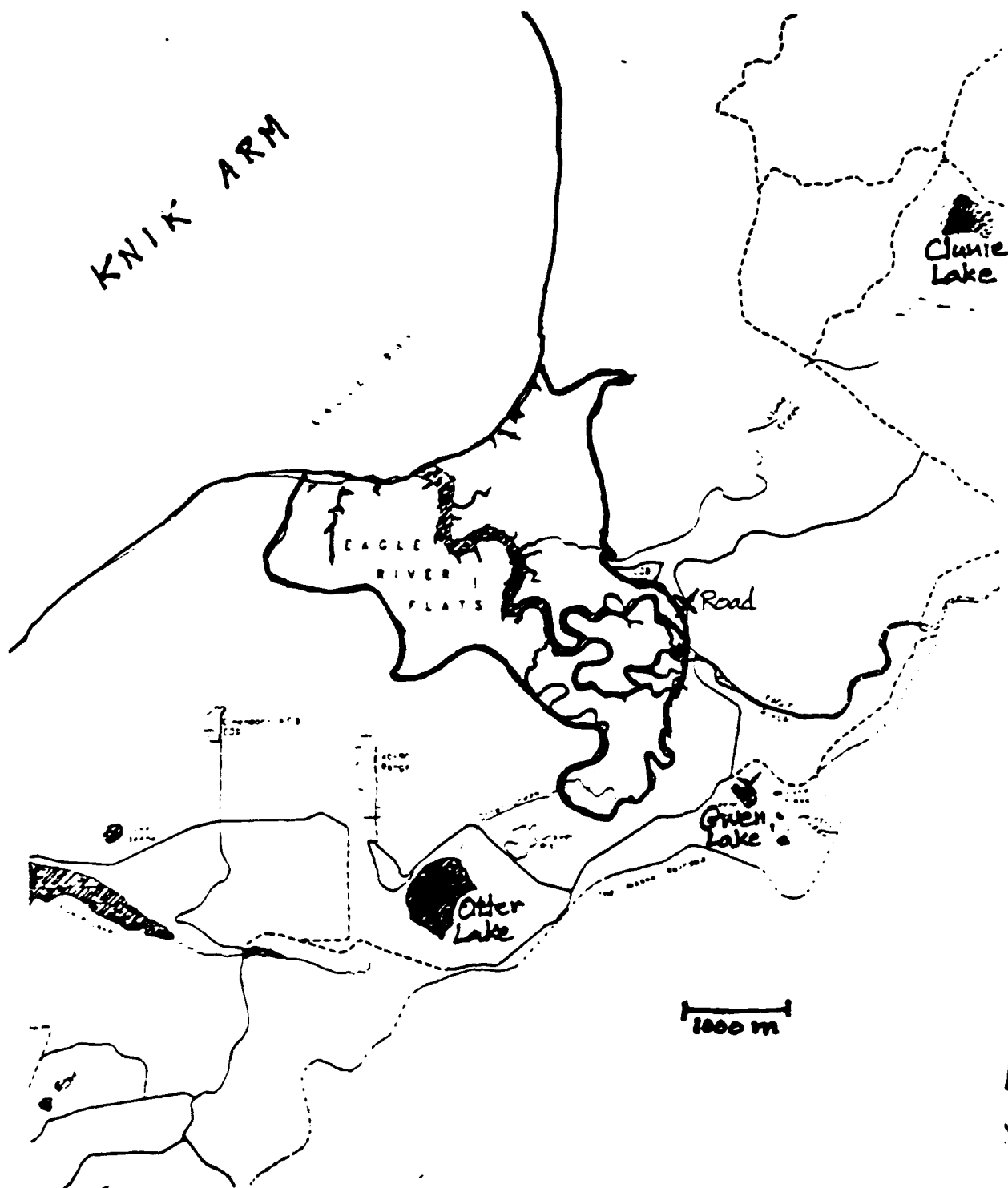

Figure VI-1. Map of the Eagle River Flats area, showing the surrounding lakes (Gwen, Clunie and Otter) where searches for waterfowl carcasses were conducted to determine if WP-poisoned waterfowl were capable of leaving ERF. X marks two locations (one at Gwen Lake and the other on the road near ERF) where a WP-containing carcass was collected (Table VI-1).

Table VI-1. WP analysis of tissues from dead waterfowl collected outside Eagle River Flats.

Species	Location	Date collected	Tissue	Mass of tissue (g)	Mass of WP (µg)	WP Conc. (µg/g)
Green-winged teal	Road	8/26/91	Gizz. contents	0.33	1155	3501
			Fat	<.1	0.35	34.6
			Skin	1.3	5.80	4.46
			Breast muscle	3.5	0.47	0.13
Grebe	Clunie Lake	6/14/91	Wing and skin	3.93	0	0
Swan	Elmendorf AFB	by B. Eldridge	Skin	5.4	0	0
Mallard	Gwen Lake	8/18/88 by mil. police	Gizz. contents	0.25	25.84	103.00
			Fat	0.39	0.15	0.39
			Skin	5.0	0.17	0.03
Loon chick	Otter Lake	7/9/91	Skin		0	0
Grebe chick	Gwen Lake	8/14/91			0	0

### Collection of Flying Waterfowl in ERF

On 28 August four teal were shot as they flew into the pond on Area C. Although they were clearly able to fly and were shot on the wing, all four contained WP (Table VI-2). Levels in one teal were similar to those in ducks found dead on the flats. Five mallards, two shovelers, one green-winged teal and one pintail were shot on September 18 near the C/D tower by Bill Eldridge (USFWS-Anchorage) and did not contain any WP (Table VI-2).

### Waterfowl Movement Patterns

#### *Observations from Blinds*

On August 24, 25 and 29, 1991, one person was stationed at each of four blinds. Each person had a radio and communicated the movement patterns of ducks throughout the flats. Flying into and out of the flats was also documented. When ducks left an area, the size and species composition of the flock was described to the observers in the tower toward which the flock was flying. Maps were developed showing the movement patterns of these flocks within ERF.



Table VI-2. Waterfowl collected while flying in Eagle River Flats and analyzed for WP. All birds were shot in Area C or the C/D transition.

Species	Date collected	Tissue	Mass of WP (ug)	WP Conc. (ug/g)
Green-winged teal	8/28/91	Gizzard contents	0.0114	0.0163
		Skin	0.2433	0.0737
		Fat	0.0414	0.0230
		Muscle	0	0
Green-winged teal	8/28/91	Gizzard contents	0.060	0.040
		Skin	0.132	0.070
		Muscle	0.042	0.011
		Fat		
Green-winged teal	8/28/91	Gizzard contents	0.109	0.156
		Skin	0.240	0.150
		Fat	0	
		Muscle	0.046	0.015
Green-winged teal	8/28/91	Gizzard contents	0.172	0.075
		Skin	2.28	1.14
		Fat	1.62	2.70
		Muscle	0.134	0.028
Five mallards	9/18/91	Gizzard contents	0	0
		Skin	0	0
		Fat	0	0
		Muscle	0	0
Two shovelers	9/18/91	Gizzard contents	0	0
		Skin	0	0
		Fat	0	0
		Muscle	0	0
Green-winged teal	9/18/91	Gizzard contents	0	0
		Skin	0	0
		Fat	0	0
		Muscle	0	0
Pintail	9/18/91	Gizzard contents	0	0
		Skin	0	0
		Fat	0	0
		Muscle	0	0

Ducks were observed routinely flying from one area to another. Of the 527 ducks seen flying over the three days of observations, only six (1%) were seen entering the flats from the northeast off the Knik Arm and 55 (10.4%) were seen leaving ERF. Most of the flying occurred between areas within ERF. The summary map (Fig. VI-2) shows that individuals of all the commonly seen waterfowl species move from Area C and the Bread Truck Pond, the areas with the highest concentrations of WP, to all the other areas on the flats. This summary map does not include all the recorded observations, only those in which the take-off and landing points were known. The map also does not show routes where the ducks took off or landed in an area on the flats other than the areas discussed (for example, Eagle River, Otter Creek Pond and other ponds north of the Bread Truck Pond). Also, many observations were made of ducks flying from one location to another location within an area. Excluding observations of movement within areas, a total of 98 observations were recorded, with an average flock size of 18.6 ducks.

On 29 August, seven censuses were conducted of the number of ducks on the flats. The average number of ducks counted between 0700 and 1500 was 398, with the highest count being 481. A total of 234 ducks were seen flying on 29 August, representing 58.6% of the average number counted that day and 48.6% of the highest number counted. This indicates that at least half the ducks on the flats on a given day are likely to move from one area to another.

An additional pattern we noticed from our observations was that ducks did not fly as frequently during certain periods of the day. Most of the documented flying occurred from 0700 (when the earliest observations were recorded) to 1100, with a steady decline from 1000 to 1100. Very little flying occurred from 1100 to 1330 or 1400. After 1400, activity began to increase again until about 1530. Some variation in this pattern exists between days, but the mid-day lull in activity was evident each day. Because ducks feed heavily in the morning hours and then settle down to preen and wash during mid-day, there may be a greater tendency to see ducks get sick during mid-day when individuals are in one location for an extended time, especially after having eaten heavily. The flying that occurs in the morning also suggests that ducks could ingest WP in one area and relocate before the mid-day lull, when they may then get sick and die.

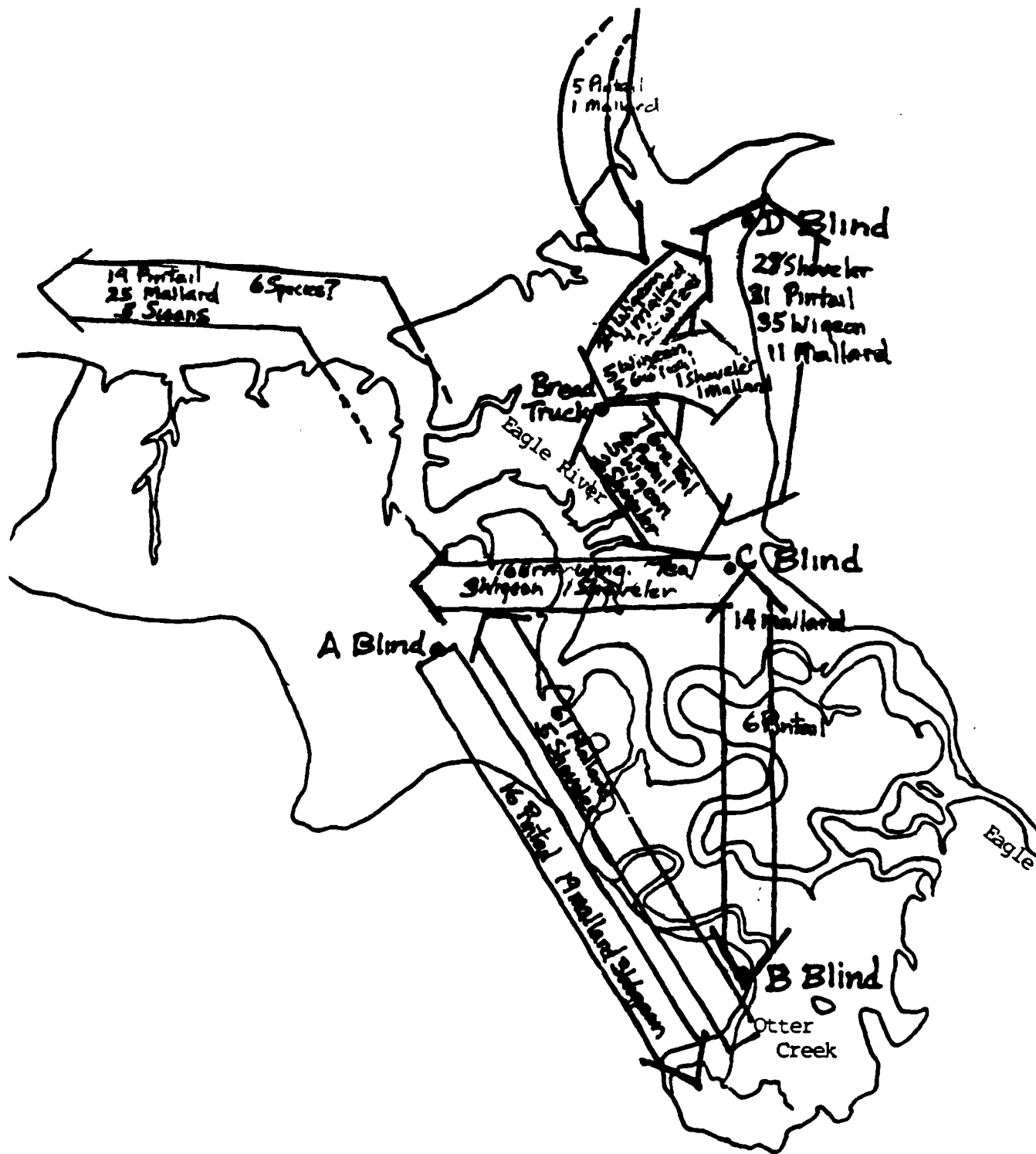

Figure VI-2. Outline map of Eagle River Flats showing the movement patterns of various numbers of several waterfowl species as determined by observers stationed in four blinds (A, B, C and D) with radio communication during 24, 25 and 26 August 1991.

### *Trapping and Banding*

The second technique involved trapping and then marking birds with patagial tags (Baldassarre et al. 1980) prior to their release. The marked birds were then resighted<sup>d</sup> as often as possible in ERF. Trapping efforts were initiated on 3 July by the DEH with the installation of two Medicine Hat traps baited with barley, one in Area C and one in Area D. On 9 August, bait was placed in two areas near the Area A tower. Up to six bait sites were maintained through 15 September, but only Area D attracted ducks.

Trapping of dabbling ducks during the 1991 fall migration was not productive; only six ducks were trapped (Table VI-3). For the past two years, bait traps have been successfully used in the upper Cook Inlet marshes to capture northern pintails and mallards. However, on Eagle River Flats the ducks showed little interest in grain, apparently due to the abundance of natural foods. Five American wigeon (*Anas americana*) and one ring-necked duck (*Aythya collaris*) were captured before high tides and poor roads forced the closure of Area D on 10 September (Table VI-3). Other bait sites were used by Canada geese (*Branta canadensis*) and greater white-fronted geese (*Anser albifrons*) and muskrats (*Ondatra zibethica*).

On 26 August, one mallard and two American wigeon were captured on ERF with a dipnet from a helicopter (Table VI-3). A northern shoveler was netted in Goose Bay. Captured ducks were banded and tagged with sequentially numbered yellow markers. One wigeon, in poor condition, and the ring-necked duck were not tagged.

Three of the tagged waterfowl (100, 107 and 103) were resighted in ERF two to three weeks after tagging. A northern shoveler originally trapped at Goose Bay and tagged in ERF was shot by a hunter on Palmer Hay Flats in early September. No WP was found in the gizzard of this duck.

### *Radio telemetry*

The immature male mallard (patagial tag 102), was captured using a dipnet on July 26, fitted with a 20-gm backpack mortality-mode transmitter (number 149.102), and released. It was subsequently located six times or more per week from 27 August through 25 September (Fig. VI-3). All locations were on the Eagle River Flats, 48% were in the bulrushes between the large ponds in C and the Beaver Pond. On three occasions the bird was flushed from this area.

Table VI-3. Waterfowl trapped and tagged in ERF during the 1991 field season.

Date	Method	Area	Species	Age	Sex	Patagial
8/26	Dipnet	B	Wigeon	HY	F	100*
8/26	Dipnet	B	Wigeon	HY	F	101
8/26	Dipnet	B	Mallard	HY	M	102
8/26	Dipnet	Goose Bay	Shoveler	HY	M	103**
9/6	Trap	D	Wigeon	HY	M	104***
9/6	Trap	D	Wigeon	HY	F	105
9/8	Trap	D	Wigeon	HY	F	106
9/10	Trap	D	Wigeon	HY	F	107***
9/10	Trap	D	Ringneck	HY	-	-
9/10	Trap	D	Wigeon	HY	F	-

\*Sighted 9/8 in B, 9/18 in D.

\*\*Shot by a hunter on Palmer Hay Flats.

\*\*\*Sighted 9/24 in pond between beaver pond and D.

Mallard 149.102 exhibited a home range of 350 ha (870 acres), with daily flight distances ranging from 0.1 to 1.9 km (Fig. VI-3). This duck exhibited localized flights between and within different portions of the ERF, often remaining in one location throughout the day. When last located, this mallard was still alive after spending at least 29 days on the ERF.

## DISCUSSION AND CONCLUSIONS

The evidence presented above suggests that during the August 1991 study period individual waterfowl spent considerable time within ERF and moved regularly between feeding Areas A, B, C, C/D, D and the Bread Truck Pond. The results also show that a duck can survive on the flats for at least a month without dying of WP poisoning.



Figure VI-3. Outline map of Eagle River Flats showing the movement patterns of an immature male mallard fitted with a radio-transmitter on 26 August 1991, released and then located six times or more per week from 27 August to 25 September 1991.

Table VI-4. WP analysis of decayed carcasses collected on 30 August 1991.

Species	Tissue	Tissue mass (g)	Mass of WP ( $\mu$ g)	WP Conc. ( $\mu$ g/g)
Mallard	Skin	2.90	0.21697	0.0748
	Larvae	0.80	0	0
Green-winged teal	Skin	1.90	0.86846	0.4571
	Larvae	0.20	0	0
Mallard	Skin	6.60	0.21297	0.0323
Green-winged teal	Skin	2.90	0.19133	0.0660
	Larvae	0.10	0	0

The movement of ducks between areas is understandable from an ecological point of view. By regularly moving to new areas, individuals or flocks reduce the chances of depleting food resources and reduce the risk of being preyed upon by predators restricted to a specific area. This movement, along with the finding of WP in waterfowl capable of flying and in carcasses found in Gwen Lake and on the road to ERF, substantiates the possibility of ducks ingesting WP in one area and flying to another area where they die. Limited data indicate that carcasses retain WP during decomposition, and this represents redistribution of WP in relatively small quantities to different areas within the flats (Table VI-4).

The documentation of ducks entering and leaving the flats, along with the record of the ducks with patagial tags being resighted or shot in other flats on the Cook Inlet, suggests that at least a few ducks fly from one salt marsh to another. We have no evidence of the transport of WP by flying ducks to other salt marshes on the Cook Inlet.





## SECTION VII. WATERFOWL MORTALITY PATTERNS AND ESTIMATES

### INTRODUCTION

During the 1991 field season, studies were initiated to measure the distribution and magnitude of WP poisoning of birds in ERF. The main goals of these studies were:

- To examine the spatial and temporal patterns of mortality in order to direct sediment sampling into areas of high mortality and to determine if there is a correlation between the distribution of WP in the sediments and the locations of waterfowl mortality;
- To determine what waterfowl species and sediment-feeding shorebird species are dying due to WP poisoning;
- To design a standardized mortality index technique with which to efficiently monitor the relative rates of mortality over time and make it possible to evaluate the effectiveness of future remediation efforts; and
- To apply and test this mortality index technique in several areas of ERF and use it to estimate the total number of dying waterfowl.

Various attempts to count the numbers and species of bird carcasses in various parts of ERF were made between 1983 and 1990 (Table VII-1). Both ground searches and observer inventories have been made. However, accurate estimates of waterfowl mortality are difficult to obtain in an area as large as the 1000-ha (2500-acre) ERF. These aerial and ground counts of dead ducks on ERF underestimated the actual mortality on the flats for three reasons:

- Predators such as bald eagles, gulls and ravens remove sick and dead ducks from the flats and carry them into the forest bordering ERF. In the spring, these removal rates are high due to the large number of bald eagles feeding at ERF (see Section VIII).
- Carcasses decompose and sink before they are found.
- Most poisoned ducks seek shelter and eventually die in taller and denser clumps of vegetation, making them difficult or impossible to see from the air (or on the ground).

Table VII-1. Summary of waterfowl mortality counts and estimates made between 1982 and 1990.

Date	Number of searches	Number of searchers	ERF area	Number of carcasses	Mortality estimate
<i>Ground counts</i>					
August 1982	1	1	Fox Point	n.d.*	
September–October 1983	5	5	A	159	
			B	21	
			C	71	
			D	117	
			Total	368	
August 1984	4	2–11	A	140	
September 1984	1	1	A	29	
16 May 1985	1	8	C	70	
20 April–7 October 1988	26	34	D, C/D, C	358†	1000
<i>Observations</i>					
May 1989 ESE (rates per hour)		?	A, C, D		2500–3000
1990 DEH aerial count (May–Oct.)	10	1	A, B, C, C/D, D	187	

\* n.d. = not determined.

† 573 feather piles also found.

For example, on August 27, 1991, we found nine dead ducks in bulrushes in a 200- × 10-m area while a helicopter survey detected seven dead ducks on the entire flats. However, the large size and conspicuous white plumage of swans allow for accurate counts of swan mortality from helicopters.

Past mortality counts were made on foot and often involved several individuals walking over certain areas of the flats during either the spring or fall (Table VII-1). The most intensive count of dead birds involved 26 different foot searches between 20 April and 7 October 1988 by two to four searchers along the east side of ERF from Area D through Area C/D into Area C (Tweten 1989). A total of 350 man-hours were spent on this 1988 count, and almost 1000 dead waterfowl were tabulated (Table VII-2).

*Table VII-2. Numbers of carcasses and feather piles either observed or collected between 3 April and 3 November 1988 (Tweten 1989).*

<u>Species</u>	<u>Fresh carcasses</u>	<u>Feather piles</u>
Northern pintail	117	118
Mallard	113	46
Green-winged teal	97	62
Northern shoveler	13	28
American wigeon	1	5
Gadwall	1	0
Least sandpiper	1	0
Semipalmated sandpiper	1	0
Dowitcher sp.	1	0
Yellowlegs	1	0
Swans	10	2
Bald eagle	1	0
Mew gull	1	0
Raven	0	1
Canada goose	0	2
Unknown ducks	0	254
Unknown shorebird	0	14
Unknown gull	0	1
<b>Total</b>	<b>368</b>	<b>573</b>

## METHODS

### Observations of Waterfowl Mortality and Symptoms of WP Poisoning

Intensive observations of waterfowl from towers in Areas A, C, C/D and the blind in D were used to locate and map sick and dying ducks, observe symptoms of WP poisoning, watch predation and count the numbers of each species using the ponds. Observations were made mostly in Area C during four migration periods: 9–16 September 1990, 18–31 May 1991, 18–30 August 1991 and 21–25 September 1991 (Table VII-3). In addition, Ft. Richardson per-

Table VII-3. Number of hours spent observing waterfowl and predators in the various areas of Eagle River Flats.

Dates	Area A	Area B	Bread Truck			Total
			Pond	Area C/D	Area D	
10-16 September 1990	0	100	0	0	0	100
19-31 May 1991	6	163	4	6	4	183
19-30 August 1991	9	40	9	17.5	3	78.5
Total	15	303	13	23.5	7	361.5

sonnel made occasional observations throughout the summer of 1991. Our observations usually extended from 0730 to 1800 each day.

#### Ground Counts of Mortality

Past ground searches and carcass counts in various areas of ERF have not been systematically carried out along marked and defined transects or areas. The actual ground area searched by individual searchers varied from week to week since no defined transects were established. In August 1991 a mortality sampling technique was designed that is based on counting carcasses and feather piles each time in exactly the same area using permanent transects of known length and width.

Transects in Areas A, C, C/D, D and the Bread Truck Pond were established, and counts made in each transect three or four times over a 10-day period in late August 1991. Dead ducks found on transects were labeled with metal tags to prevent recounting the same carcasses and to determine if carcasses are removed. Carcasses and feather piles were counted in two types of transects (Fig. VII-1). The "D" or density transect is a 10-m-wide belt transect of known length and area so as to obtain a measure of the number of carcasses or feather piles per unit area. These D transects were located so as to include the four major vegetation-habitat types around each feeding pond area. These types were bulrush, sedge, mudflat and open water with clumps of vegetation (I/W: island-water complex). We expected to find different numbers of carcasses in each of these four vegetation types because of the influence on sick ducks as well as the rates of removal by predators. Predator removal is more rapid in open mudflats and the island-water complex than in tall bul-

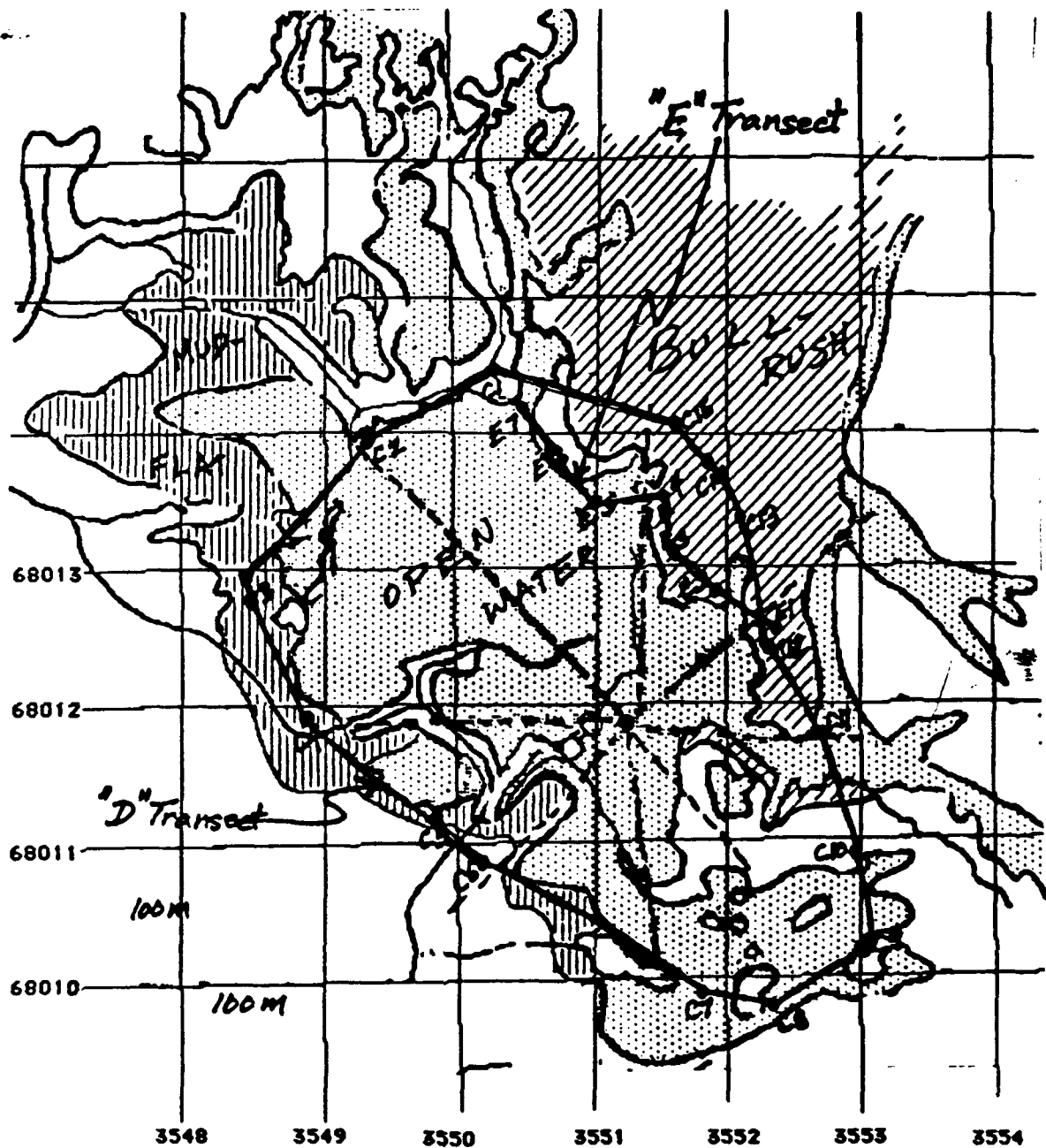

Figure VII-1. Map of Area C showing the location of the density or D transect surrounding the main pond area in which carcasses were counted in a 1400-m-long  $\times$  10-m-wide belt, and the edge or E transect where carcasses tended to accumulate in large numbers.

rush vegetation, where sick ducks often hide to escape predators. We assumed that our transects represented typical mortality density in each area.

The second type of transect is the "E" or edge transect of undefined width, established along the edges of the main water bodies where we expected to find high concentrations of carcasses (because wind may push floating carcasses to the pond edge or because sick birds tend to seek cover along the pond edge) (Fig. VII-1); the larger carcass numbers in these transects permit easier measurement and detection of relative mortality of each species and changes in mortality in subsequent years.

## RESULTS

### Mortality of Waterfowl Species

Of the 106 duck carcasses counted in all the mortality transects in ERF, 44 (42%) were green-winged teal, 27 (25%) were northern pintail, 18 (17%) were mallards, 1 was a wigeon and the rest were too decomposed to identify. Green-winged teal, northern pintails and mallards are the most frequently found carcasses in ERF (Table VII-2). When the percentages of carcasses belonging to each species in Area C are compared with the percentages for the numbers of each species using the Area C ponds (as observed from the tower), mallards and pintails appear to be dying in proportionately greater numbers than other waterfowl using the area (Table VII-4). This suggests that they may be more susceptible than green-winged teal to WP poisoning. Of the dabbling ducks using Area C in August, wigeon are clearly the least susceptible to WP poisoning. The number of mallards using the pond may be underestimated due to their use of densely vegetated areas (bulrush vegetation) in Area C rather than the ponds that were being observed from the tower. Although shoveler carcasses have been found, they did not comprise a significant percentage of the birds using the ponds.

### Mortality of Non-Waterfowl Species

During the 1991 field season we found six dead red-necked phalaropes and saw one die (Table VII-5). All seven had WP in their gizzards and tissues, and the three females collected also had WP in eggs still within their bodies. In

*Table VII-4. Percentage of four species of dabbling ducks observed in Area C compared with the percentage of carcasses counted in the edge transect in Area C.*

Species	Ducks observed in Area C (%)	Carcasses in edge count of Area C (%)	Selectivity Index (%Dead-%Observed)
Green-winged teal	53	49	-4
Pintail	15	30	+15
Mallard	2	20	+18
Wigeon	27	1	-26
Shoveler	3	0	-3

addition to these phalaropes, two sandpipers were collected, one in June and one in September. These birds also had WP in their gizzards.

Many shorebird species feed on the flats from spring to fall. The most common are short-billed dowitchers and lesser yellowlegs, although phalaropes are also abundant in spring and probably breed at ERF. The phalaropes appear to be the only species that do not aggressively probe into the sediments for food, yet more dead phalaropes have been found than dead birds of any of the other shorebird species. It is possible that shorebirds die regularly from WP poisoning but are either too small to detect or fly off the flats and die somewhere else, for example on the edge of the Cook Inlet where they may communally preen and wash.

#### Temporal Patterns of Mortality

Mortality of waterfowl was observed during all three observation periods including September 1990, May 1991 and August 1991. However, during 21-25 September 1991, no mortality was noted by observers in either areas C, C/D or D. This absence of mortality was correlated with the absence of waterfowl feeding in either Area C or the Bread Truck Pond. On 25 September 1991, over 1000 ducks were counted in Area D, while none were seen in Area C. Also during this time period, an average of 60 swans fed in Area D and none used Area C. These observations are interesting, but the mortality transects established in August were not walked and no systematic observations were made in Area C or the Bread Truck Pond. Therefore, because there are no quantita-

Table VII-5. Tissue analysis for white phosphorus of shorebird carcasses from Eagle River Flats.

Species	Sex	Area	Date collected	Tissue	Mass (g)	Mass of WP ( $\mu$ g)	Conc. of WP ( $\mu$ g/g)
Red-necked phalarope	F	C	5/27/91	Gizz. and cont.	0.46	0.0514	0.112
				Skin	1.21	0.546	0.451
				Egg Yolk	1.39	0.0432	0.0311
Red-necked phalarope	F	C	5/27/91	Gizz. and cont.	0.78	0.848	1.09
				Skin	1.25	3.98	3.19
Red-necked phalarope	?	road to D	5/27/91	Gut pile	2.96	13.5	4.57
Red-necked phalarope	F	C	5/28/91	Gizz. and cont.	0.84	1.18	1.4
				Skin	0.43	1.32	3.06
				Yolk 1	2.48	0.036	0.015
				Yolk 2	0.71	0.104	0.146
Red-necked phalarope	F	C	5/28/91	Gizz. and cont.	0.97	263	271
				Skin	0.32	0.37	1.15
				Egg Yolk	3.22	0.34	0.11
Red-necked phalarope	M	C	5/29/91	Gizz. and cont.	0.68	1.15	1.68
				Skin	0.46	0.27	0.59
				Testes	0.33	0	0
Red-necked phalarope	F	C	5/31/91	Gizz. and cont.	0.92	15,500	16,800
				Skin	0.18	0.11	0.61
Sandpiper	F	C	6/18/91	Gizzard cont.	0.43	12.4	28.7
				Fat	0.74	0.35	0.47
				Fat	0.5	0.32	0.64
				Skin	1.05	0.35	0.33
				Breast muscle	4.98	0.03	0.006
Sandpiper	?	?	9/?/90	Gizz. and cont.	2.71	0.21	0.078

tive data from September, it is difficult to confirm the "suspicion" that the absence of mortality in September is related to the avoidance of the highly contaminated Area C and Bread Truck ponds. During this time waterfowl also often feed on an abundant crop of seeds floating on the surface of the water, not in the sediments.



### Observations and Locations of Sick and Dying Waterfowl in Area C

During the three observation periods (September 1990, May 1991 and August 1991), a total of 19 ducks (17 green-winged teal and two pintails) and 3 shorebirds (phalaropes) were observed to get sick and eventually die in Area C (Fig. VII-2). WP was found in the gizzards of all these individuals. All but four of these birds died in the northern half of the Area C pond, and most were located along the edge of the main pond (Fig. VII-2). We also saw many other birds show early symptoms of sickness, but they flew to other areas and WP intoxication could not be confirmed as the cause of their behavior. In addition 15 other ducks were carried off by predators from Area C in May 1991 (Section VIII).

In May 1991, during observations from the tower in Area C, we saw bald eagles and gulls consuming duck carcasses in the Bread Truck Pond. This resulted in the sampling and discovery of large amounts of WP in the bottom sediments of this pond.

### Transect Mortality Counts during August 1991

From August 20 to 30 we performed 28 ground counts in density and/or edge transects located in five areas and found 106 dead ducks and three dead swans (Table VII-6). Seventy (66%) of the ducks were counted in edge transects (E counts), with the remaining 36 in the density transects. Fifty-six of the ducks were found in Area C, 26 in Area A, 17 in the Bread Truck Pond, nine in C/D, and only one in Area D.

#### *Area C*

In Area C the density transect ran 1404 m in a circular course around the C tower (Fig. VII-1) and covered an area of 1.4 ha (Table VII-7). This transect crossed bulrushes to the northeast, tall sedge to the northwest and southeast, and mudflat to the west. The edge transect, varying from 10 to 15 m wide, ran along the northeast shoreline of the main pool in Area C (Fig. VII-1). Counts in Area C were made on 20, 25, 27 and 30 August (Table VII-6). A total of 56 carcasses were counted in both the density and edge transects, with 41 of these in the edge transect along the northeast edge of this pond. Counting the 15 carcasses from the density transect, we calculate a density of 10.7 carcasses/ha (Table VII-7). This area probably contained high numbers of dead ducks because ducks that feed in the main pool and become sick take cover in the tall

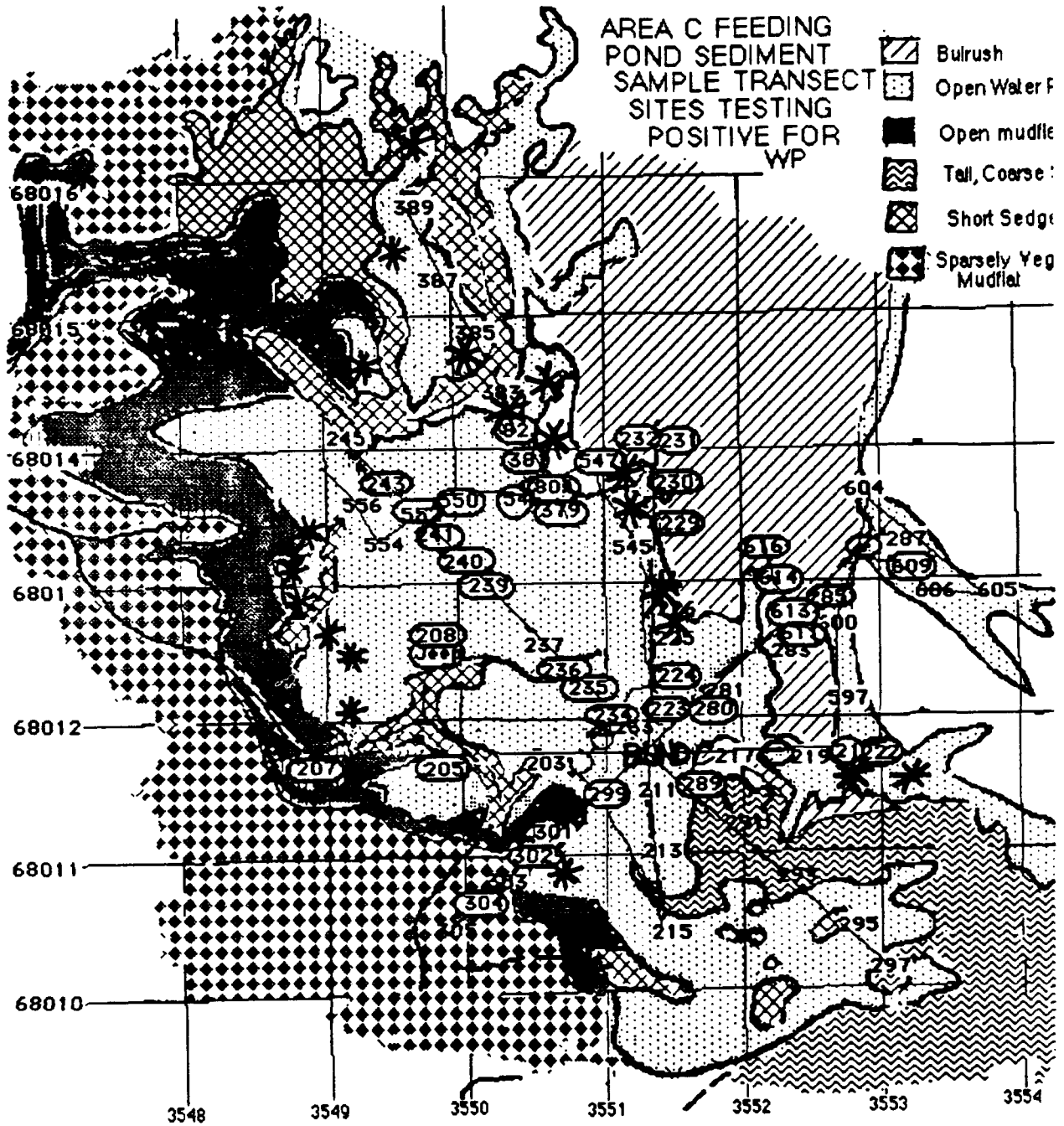

Figure VII-2. Habitat map of Area C showing the location of sediment samples testing positive for WP (239) and locations where 22 waterbirds were observed to become sick and die during observation periods in September 1990, May 1991 and August 1991.

Table VII-6. Number of dead ducks counted in each transect and in each area.

Date	A		C		C/D	D	Bread Truck Pond
	Dcount*	Ecount**	Dcount	Ecount	Ecount	Dcount	Dcount
Aug. 20	NC	NC	Pt 1	GwT7 Pt 10 Ma 1 unk. 9	NC	NC	NC
Aug. 21	NC	NC	NC	NC	GwT2 Swan 1 unk. 3	Pt 1	NC
Aug. 22	NC	NC	NC	NC	NC	NC	GwT5 Pt 1 Ma 1 unk. 3
Aug. 23	GwT1 Pt 1 Ma 2 Swan 1	Ma 8 Pt 6	NC	NC	NC	NC	NC
Aug. 24	NC	NC	NC	NC	GwT1 Swan 1	NC	NC
Aug. 25	NC	NC	GwT1 Pt 1	NC	NC	NC	NC
Aug. 27	NC	NC	GwT5 Pt 2	GwT6 Ma 3	GwT1	NC	GwT3
Aug. 28	Pt 1	GwT3 Pt 2 Wi 1	NC	NC	NC	NC	NC
Aug. 30	0	0	GwT3 Pt 2	GwT4 Ma 1	0	0	GwT2
Totals	Gwt 1 Pt 2 Ma 2 Swan 1	GwT3 Pt 8 Ma 8 Wi 1	GwT9 Pt 6	GwT17 Pt 10 Ma 5 unk. 9	GwT4 Swan 2 unk. 3	Pt 1	GwT10 Pt 1 Ma 3 unk. 3
Area totals	6	20	15	41	9	1	17

Grand total = 109

\*D counts = transects used for density measurements in estimating mortality

\*\*E counts = edge counts used only as indices of relative mortality (see text for details)

GwT - Green-winged Teal

Pt - Pintail

Ma - Mallard

Wi - Wigeon

unk. - unknown species, carcass too decomposed to identify species

NC = no count made in this area on this data

bulrushes lining this section of the pool, and because ducks that die in open water and are not removed by scavengers are likely to be pushed into this edge of the pond by the prevailing wind.

*Table VII-7. Total number of dead ducks counted on each density transect, the total area searched and the resulting density of dead ducks in Areas A, C, D and the Bread Truck Pond.*

<u>Area</u>	<u>No. of dead ducks</u>	<u>Area searched (ha)</u>	<u>Density (ducks/ha)</u>
A	6	0.64	9.4
C	15	1.40	10.7
Bread Truck Pond	17	1.05	16.2
D	1	0.60	1.7

#### *Bread Truck Pond*

The Bread Truck Pond is a combination of open water with clumps of sedge forming many small islands (Fig. V-8). There is also an area of sedge meadow along the north edge of the main 5.1-ha pond and some bulrush along the southeast edge of the pond. A density transect (10 m wide by 1054 m long) was established and marked; on 22, 27 and 30 August, both carcasses and feather piles (including enough body parts to be identifiable as a dead duck) were counted.

A total of 17 carcasses were found in the Bread Truck Pond density transect, with 14 of these represented by feather piles only. The resulting density of 16.2 carcasses per hectare is the highest density measured in the various areas (Table VII-7). The high rate of predation here suggests that many more sick or dead ducks may have been removed from the Bread Truck Pond by predators and will result in a low estimate of the actual mortality if the mortality estimate is based on carcass counts. Few of the dead ducks in counts from other areas were represented by feather piles (in Area C only four out of 56). The short-sedge meadow and mudflats that dominate this area make sick and dead ducks more visible to predators than in areas with taller bulrush.

*Area A*

Area A is an extensive area of interspersed bulrush and open water. We established a 530-m-long density transect following the marked grids where sediment samples had been taken (Fig. V-3). We also established an edge transect and counted carcasses from a canoe along the perimeter of the larger open water areas south of the A tower. Both density and edge counts were obtained on 23, 28 and 30 August. Carcass density was only 9.4 per hectare. Twenty-six carcasses were counted, with 20 (77%) of these from the edge count.

*Area C/D*

Area C/D includes mostly bulrush interspersed with small deep ponds. The deep water made it necessary to establish an edge transect that could be traversed by canoe (Fig. V-6). Counts were made on 21, 24, 27 and 30 August. Only 10 carcasses were counted here.

*Area D*

Area D consists mainly of a fairly deep pond with islands of tall bulrush (Fig. V-7). A 16-m-wide density transect ran for 375 m and counts made using a canoe. Counts on this transect were conducted on 21, 24 and 30 August. Only one carcass was found, so the density was only 1.7 carcasses per hectare.

**Estimates of August 1991 Mortality**

The primary purpose of the mortality transects was to monitor relative mortality in the same area over time. However, mortality transect data can also be used to derive a total estimate of mortality by making several assumptions about the data. The main assumption is that the number of dead ducks found in each habitat type in the mortality density transect is representative of the density of dead ducks in that habitat type farther away from the transect. We realize that our transects are in close proximity to feeding areas that have higher mortality, but the transects are actually 20 m from the feeding ponds. For example, in Area C we found seven ducks in the bulrush habitat of the density transect about 20 m from the edge of the main pond. This contrasts with 41 duck carcasses counted in the edge transect on the edge of the main pond in Area C.

The method involves calculating the area of each of four vegetation types that transects passed through. Then the number of carcasses or feather piles of

Table VII-8. Number of dead waterfowl of each species in density mortality transects counted during August 1991 in each of three vegetation types grouped by areas on the east side of Eagle River Flats (C, C/D, D and the Bread Truck Pond) and for Area A on the west side of ERF. The total area in each vegetation type was calculated from aerial photos.

	<u>Dead ducks counted</u>			<u>Area censused (ha)</u>			<u>Total area (ha)</u>			<u>Mortality estimate</u>		
	Sedge	Bulrush	water	Sedge	Bulrush	water	Sedge	Bulrush	water	Sedge	Bulrush	water
<i>Areas C, C/D, D and the Bread Truck Pond</i>												
GwTeal	12	6	5	1.33	0.52	0.60	34.6	46.2	18.6	312	533	155
Pintail	2	5	1							52	444	31
Unknown	0	1	3							0	89	93
Subtotal	14	12	9							364	1066	279
<i>Area A</i>												
GwTeal	1				0.64			17.0				27
Pintail	2											53
Mallard	2											53
Subtotal	5											133
<i>Total for All Areas and Habitats</i>												
	40			3.0			116.5			1842		

each species in each vegetation type is determined. The number of dead ducks per area for each habitat is then applied to the total area in each vegetation type to obtain the total number of individuals of each species dying in each vegetation type (Table VII-8). For example, this is how mortality was calculated for green-winged teal:

1. Number of dead green-winged teal counted in tall sedge on D counts in Areas C, C/D, D and the Bread Truck Pond = 12.
2. Total area of sedge included in D counts = 1.33 ha.
3. Total area of sedge in Areas C, C/D, D and the Bread Truck Pond = 34.6 ha.
4. Number of green-winged teal that died in sedge in August =  $(12) \times (34.6)/1.33 = 312$ .
5. The totals of each species in each vegetation type in Areas A, C, C/D, D and the Bread Truck Pond were then added to obtain the total number of ducks that died in August.

The total number of ducks estimated to have died between early August and the end of August 1991 in Areas C, C/D, D and the Bread Truck Pond is 1842 (Table VII-8). Our counts included old carcasses, so we assume that most of the early fall migrants are included. In addition, resident individuals may have died on our transects, so we consider our counts to estimate mortality for all of August, even though our counts did not begin until August 20.

## DISCUSSION

### Mortality Estimate

Our mortality estimate of 1842 dead ducks in August 1991 is not unreasonably high compared to previous estimates. In the spring of 1989, ESE (1990) estimated that 2500–3000 ducks were affected in a four-week period during the peak of migration in May. In August 1988, 232 dead ducks were counted by 3–4 people walking from Area D to Area C. Assuming that these ground searches covered about 20% of the 74-ha area represented by this search, the density of carcasses (16 carcasses per hectare) is similar to that obtained by our density counts in Areas C, C/D and D. A third piece of evidence supports the conclusion that mortality in ERF is much greater than the 1000–2000 waterfowl usually quoted: during May 1991 we observed that 80% of the dead or dying ducks preyed upon by eagles were removed from ERF and were therefore not counted in either the 1988 ground searches or 1991 transects. If this percentage is applied to the number of feather piles (573) (which represents ducks eaten in situ) counted in the spring of 1988, the estimated mortality for 1988 in a limited area of ERF is much greater than 1000.

### Spatial–Temporal Patterns of Mortality

If the density counts alone are compared, and if the counts are scaled by the amount of area covered, then the Bread Truck Pond had the highest density of dead ducks, followed by Area C and then Area A (Table VII-7). This pattern of mortality is consistent with the pattern of the distribution of WP in the sediments, with the highest occurrence and concentration of WP in Areas C and the Bread Truck Pond. The highest concentration of carcasses we have encountered anywhere on the flats is in the bulrushes along the northeast edge of the main pool in Area C, where high levels of WP were detected in

the sediments. At two spatial scales (the entire ERF and within Area C), there is a correlation between the location of WP in the sediments and the location of dead ducks and high incidences of predation on ducks. Most ducks probably die near where they ingest WP. However, the fact that dead ducks are found in areas with little or no WP in the sediments (Areas D and B) demonstrates that some ducks ingest WP and then fly 1000 m or more before dying. Evidence for the ability of poisoned ducks to fly include the finding of WP in the gizzards of four flying teal in Area C and the observation of several ducks with presumed early symptoms of poisoning flying considerable distances, e.g., from Area C to Area A.

### Shorebird Mortality

The finding of WP poisoning of shorebirds raises questions about the risk of mortality to these species. We have found feather piles both on the flats and in the bordering forest that were clearly shorebirds. We were puzzled after our initial observations in 1990 as to why these sediment-probing shorebirds did not appear to ingest WP or to suffer ill effects if they did. We are now aware that shorebirds are at some risk. Further observation and mortality counts are needed to determine the severity of the risk. In red-necked phalaropes, the source of WP may be suspended WP in the water column, where this species is known to feed (Dodson and Egger 1980).

### Future Use of Mortality Transects

The results presented above show that marked and measured transects can be used effectively in the future to monitor mortality in ERF. Assessments of methods to determine waterfowl die-offs from lead shot poisoning have been conducted by Humburg et al. (1984). We believe a continuation of these transect counts would be the best way to assess the effectiveness of any remediation attempts. The transects are marked and have been cleared by EOD, posing minimal threat to whomever conducts the counts. There are several advantages to this method. First, these counts can be conducted quickly, providing an inexpensive (compared to helicopter counts) and more reliable index of mortality. Second, this method is repeatable and therefore should indicate changes in mortality for whatever reasons.

The basic requirements for continued use of transects are:



- They will be walked or canoed at five-day intervals in August or September and possibly in May or June; and
- Carcasses and feather piles within 5 m of the centerline on both sides of the transect will be counted and tagged with metal bands.

Three levels of transect carcass counts could be made, requiring different amounts of time and effort to complete an inventory.

*Level I: Count in Area C Only*

The least-intensive repeatable index would be conducted in Area C. We have already established a transect we refer to as the edge transect (Fig. VII-1). This transect is along the northeast shoreline of the main pool of Area C and is clearly the section with the highest number of carcasses (Table VII-6). This transect is one of the most concentrated areas of dead ducks, probably because ducks in the main pond that get sick seek shelter in this tall bulrush and because it includes ducks that die in open water and float into the vegetation. The transect is 10 m wide from E-1 to E-5 and 15 m wide from E-5 to E-8, including several islands from E-5 to E-8 (Fig. VII-1).

In addition to counting dead ducks in this edge transect, part of the density transect already established in Area C also should be covered, specifically C-7 to C-15 and C-15 to C-1 comprising the eastern edge of the transect (Fig. VII-1). This was the area of highest mortality within the density transect.

These transects should be walked at five-day intervals beginning in mid-August (e.g., August 15, 20, 25, 30, September 4, 9 and 14) for a total of seven repeated counts. We approximate about three hours per count, not including the time getting to the flats.

*Level II: Counts in Areas C, A and C/D*

Both the transects mentioned in Level I would be counted, as well as two other already-established canoe transects around the pond southeast of the tower in Area A and along the edge of the pond in Area C/D.

These routes should be covered on the same dates mentioned in Level I. We approximate that these routes would take six hours, not including transportation between areas. We include these two canoe routes because of the relatively high numbers of dead ducks we have counted in these areas.

*Level III: Spring and Fall Counts and Observations in Areas C, A and C/D*

This level would be the most thorough assessment of mortality in different areas. It represents the best way to assess the effects of remediation in different areas.

All the above counts would be included as part of Level III. In addition, we propose that an additional transect be established in the large area of bulrush between Areas C and C/D and that the counts be conducted in the spring as well (e.g., May 10, 15, 20, 25, 30 and June 4) for a total of six counts in spring and six in late summer or fall. We also propose that at least four 10-hour days of observation from the tower in Area C be conducted from May 15 to 30 and at least two 10-hour periods in late summer or fall to monitor predator removal rates.

Based on past observations the removal of carcasses from the flats, principally by bald eagles, represents a significant proportion of the ducks dying in the spring (up to 80% during May 1991). These observation periods also would provide information regarding the relation between the use of Area C by waterfowl and the number of ducks dying. Only by censusing the number of individuals of each species feeding can we determine with any degree of accuracy the correlation between use of the flats and mortality on the flats.

## SECTION VIII. RISK OF WHITE PHOSPHORUS POISONING OF WATERFOWL PREDATORS

### INTRODUCTION

Evidence of predation on waterfowl in ERF include observations of predation events and numerous bird remains, consisting primarily of feathers from scavenged carcasses. These "feather piles" can be found both on the flats and on the forest floor in the surrounding woodland. Based on this evidence of predation and the very high lipid solubility of WP [i.e. 1 g of WP is soluble in 80 mL of olive oil (Stecher 1968)], we predicted that WP could pose a risk to both predators of ducks poisoned with WP and possibly to hunters should they consume a WP-poisoned duck (see Section IX).

A 1969 spill of water containing colloidal and dissolved WP (phossy water) into a marine bay at a Newfoundland WP-manufacturing plant supports the case that WP is not particularly reactive once deposited in biological tissues and, like many other highly lipid soluble chemicals, *might be transferred* from prey to predator (Idler 1969). In the vicinity of the plant, there were massive fish kills and dead and dying herring (*Clupea harengus*), and other dead fish were found as far as 80 km from the manufacturing plant. Later studies by Fletcher (1973) showed that WP-contaminated cod liver was lethal when fed to brook trout and the symptoms of WP poisoning were identical to those observed when WP is present in water. This type of transfer of WP from prey to predator could have explained in part the finding of dead and dying fish at considerable distances from the Newfoundland spill site. Fletcher (1971) also showed that marine invertebrates and seaweed all accumulated WP. There is evidence that the distribution of WP was highest in organisms and organs with the highest lipid contents. WP-fed cod contained 194  $\mu\text{g/g}$  in the liver as compared with 4–11  $\mu\text{g/g}$  in the muscle (Fletcher 1973). Dyer et al. (1972) found that WP was still present in the edible muscle tissue of cod during processing, including icing, freezing and thawing, frozen storage, salting and cooking, and suggested that the WP was dissolved and protected from oxygenation by the tissue lipid.

To determine if WP posed a toxicological risk to predators at ERF, our approach was to carefully monitor the predation events and record the species of prey and predator. We recorded the frequency and circumstances of predation, the amount of tissues ingested from ducks poisoned at ERF, the levels of WP in the duck tissues being consumed, any evidence of the presence of WP in predator species, and any resultant obvious toxicity to those predators.

## **METHODS**

### **Field Observations of Predation Events**

Observations of waterfowl, waterfowl poisoning and predation of waterfowl were made at ERF during the spring (21–31 May) and fall (19–30 August) of 1991 from an observation tower in Area C (Fig. II-8). This time period corresponds to the major spring and fall migrations of ducks into and through the Cook Inlet of Alaska. Field observations usually started between 0700 and 0800 hours and ended between 1800 and 2000 hours. These hours encompassed the major times when ducks were feeding in ERF. Eighty hours of observations specifically looked at predation events. Of particular importance were the types of predators and whether the ducks were alive or dead when preyed upon. Particular attention was paid to the signs of WP poisoning in the waterfowl, especially with respect to those signs that attracted predators. As discussed previously (Racine et al. 1991), the signs of WP toxicity included extensive drinking, uncontrolled and frequent head shaking, lethargy and convulsions.

### **Observations and Collections of Predators**

During May and June 1991 the U.S. Army 6th ID made a number of helicopter flights over ERF to locate sick or dead bald eagles. In addition observations of predators were made from the blinds to detect any abnormal behavior perhaps related to WP poisoning. Herring gulls and gull eggs were also obtained and analyzed for WP during the field season.

### **Tissue sampling procedures**

To determine if predators were commonly exposed to WP, we routinely sampled the breast skin, breast muscle and body fat deposits of waterfowl that

had been preyed upon in Area C. For each of these tissues, approximately 5-g samples were cut from the carcass, minced when necessary to produce pieces no thicker than 3 mm and added to a preweighed, 40-mL glass vial containing 10 mL of isooctane. If available the entire gizzard contents were sampled. If a predator had fed on a carcass, we often were not able to obtain specific tissue samples and/or sample sizes. In those cases, we sampled whatever tissue was available to determine if the prey contained WP.

Several whole carcasses collected in ERF were frozen and shipped to the laboratory, where it was possible to make a more detailed sampling of tissue. To assess the amount of WP a "predator" could ingest by eating all or parts of WP-poisoned waterfowl, we weighed and sampled over 14 major organs and tissues of ERF ducks that had all shown obvious signs of WP poisoning.

#### **WP analysis**

WP analyses were accomplished according to procedures used previously (Racine et al. 1991) and detailed elsewhere in this report. WP was determined by gas chromatography.

#### **Tissue lipid analysis**

The lipid content of duck tissues was analyzed by the method of Bligh and Dyer (1959) with slight modifications. The important feature of this assay was that the tissues were first analyzed for WP, then the isooctane was allowed to evaporate under a vacuum, and the same sample was evaluated for total lipids. Since microliter quantities of isooctane were used for the analysis of WP, there was insignificant removal of lipids from the 10 mL of isooctane. The resulting data were expressed as micrograms of WP per gram of tissue lipid.

## **RESULTS**

A total of 24 predation events were observed in Area C during May 1991 (Table VIII-1), from which carcasses were recovered and analyzed. Not included are events in which the prey could not be identified.

The majority of the ducks preyed upon were green-winged teal (Table VIII-1). The teal also represented the major species of duck in Area C during these

Table VIII-1. Predation events on ducks observed between 21 and 31 May 1991 from the blind in Area C.

Prey species	Events	Sex	When preyed on:		
			Alive	Dead	Unknown
Green-winged teal	7	male	2	2	3
	4	female	2	1	1
Shoveler	1	male		1	
Pintail	1	male		1	
Unknown	11	unknown			11
<b>Total</b>	<b>24</b>				

observation periods. Of particular interest was whether the ducks were alive or dead when preyed upon. This is particularly interesting since WP toxicity involves sedation or lethargy in the ducks, allowing them to be easy prey. For example, on several occasions the predator would flush a flock of ducks and then wheel around to prey on an individual that did not flush. Another sign of WP poisoning is convulsions. This violent behavior attracted predators, especially eagles. Often bald eagles would perch on the trees on the eastern shoreline of Area C and watch the ducks feeding in Area C. Herring gulls also were attracted by ducks that were convulsing.

Predators of ducks include bald eagles, gulls and ravens (Table VIII-2). During the May 1991 field season, immature bald eagles were more common than adult bald eagles, and every day there were several eagles in ERF. Herring gulls and ravens often scavenged remains left by eagles though this was not always the case. Herring gulls and occasionally ravens were observed to kill sick ducks and consume at least a portion of the duck.

Of the 24 predation events that were observed during May in ERF, about 20 of the preyed-on birds were carried by eagles out of the flats into the bordering woodland, where the carcasses were consumed. On May 21 and 22, 1991, over 40 fresh feather piles were identified by searching the dense wood to the east of Area C from the EOD Area, north along the margin of ERF to the C/D transition area. The species of duck could often be identified from the remains in the feather pile and were the species known to be susceptible to WP

*Table VIII-2. Major predators observed to feed on sick or dead ducks at Eagle River Flats between 21 and 31 May 1991.*

<u>Primary predator</u>	<u>Number of predation events</u>
Bald eagle	
Immatres	12
Adults	3
Herring gull	7
<u>Common raven</u>	<u>2</u>

poisoning in ERF. Feather piles of shorebirds were also found suggesting that they may also be victims.

Another important feature regarding predation was the observation of multiple predators feeding on a single carcass. This included both multiple individuals of the same species and a succession of eagles followed by gulls and/or ravens. On two occasions, pairs of herring gulls were observed to feed on ducks. These pairs appeared to be offering bits of food to each other. On other occasions pairs of herring gulls were observed to search the flats together. We suspect that these pairs represented breeding pairs of herring gulls.

On May 21, 1991, an immature bald eagle was observed to eat three ducks within three hours. This was the only time that an individual predator was seen consuming several ducks. The first duck was consumed in a tree near the C/D transition area. The second was a male green-winged teal convulsing in Area C, and it was carried to a tree and consumed. Finally, a third duck was taken to a tree in this same area. It seems likely that a large predator would consume at least portions of several ducks in a single day.

Other predators, in addition to the ones we observed (Table VIII-2), may also feed on poisoned birds in ERF. During the 1991 field season, coyotes, both singly and in small groups of four or five, were observed to hunt over a wide range of the flats. Whether they prey upon sick or dead ducks is not known. In August 1991 a northern harrier (*Circus cyaneus*) was observed to feed upon a duck that had just died. The role of other less common or less commonly observed predators at ERF is not known.

Table VIII-3. Concentrations of WP in duck tissues from various carcasses collected between 21 May and 3 June 1991 in Eagle River Flats.

Species	Gizzard contents ( $\mu\text{g WP}$ )	Tissue concentration ( $\mu\text{g WP/g wet weight}$ )		
		Fat	Skin	Muscle
Green-winged teal (male)				
WP range	1310-0.021	1.80-0.52	6.34-0.012	0.022-0.001
number =10	(8)	(5)	(9)	(8)
median value	0.48	0.187	0.0733	0.007
Green-winged teal (female)				
WP range	8820-37.8	5.92-0.235	1.37-0.142	0.560-0.006
number =3	(3)	(3)	(3)	(3)
median value	1084	2.04	0.214	0.010
Shoveler (female)				
WP level	0.751	0.047	0.067	0
number =1	(1)	(1)	(1)	(1)
Mallard (male)				
WP level	1.32	0.42	0.06	0.004
number =1	(1)	(1)	(1)	(1)

Table VIII-3 summarizes the concentrations of WP in the tissues of 15 duck carcasses randomly collected primarily in Area C during the 1991 field season. The gizzard contents had WP masses that ranged from 8820  $\mu\text{g}$  to 0.021  $\mu\text{g}$ , a range of over five orders of magnitude. This wide range implies that the exposure to WP is quite variable and depends on the number and size of particles that are ingested, which in turn depends upon where the duck feeds and the extent of foraging that occurs in the contaminated sediments. The gizzard contents indicate exposure, but not absorption and tissue deposition, of WP. These 15 ducks all contained WP in their tissues, with the highest concentrations being in the fat deposits, followed by skin and muscle. Tissue concentrations, both from a single bird and from bird-to-bird comparisons, varied considerably and may reflect variations in WP exposure, rates of WP absorption, amount of tissue fat, blood supply to the specific organ or tissue or other factors. With the amount of WP found in gizzards varying by or-



*Table VIII-4. Concentration of WP in various tissues of duck carcass remains that were observed to be partially consumed by various predators in Area C between 21 and 31 May 1991.*

Prey	Predator	Comment	Sample	Conc. (ug/g)
Teal (female)	Raven	Duck convulsed and killed by raven	Gizzard	1084*
			Fat	0.235
			Skin	0.142
			Muscle	0.006
Teal (male)	Immature eagle	Predation two days prior to collection	Wing tissue	0.022
Shoveler (male)	Herring gull		Muscle	0.060
Pintail (male)	Adult eagle	Fed on by five other eagles	Wing tissue	0.017
Teal (male)	Herring gull		Unknown tissue	0.521

\* The gizzard contents are cited as mass of WP in the contents and not on a concentration basis as with tissue.

ders of magnitude, it is likely that differing exposures are the greatest variable with respect to determining the tissue concentration.

Direct evidence that predators are being exposed to WP is provided by tissues (Table VIII-4) collected from five scavenged carcasses left behind after an observed predation event (Table VIII-1). Based on these data, there is no doubt that predators are ingesting ducks with WP in their tissues.

To estimate the quantities of WP that are being ingested by predators, 10 ducks that had obvious signs of WP intoxication were collected before predation. In the laboratory we carefully weighed the ducks and dissected and weighed major organ and tissue samples. As the tissue WP concentration appears highest in those organs and tissues that are associated with high lipid contents (skin and fat deposits usually have higher WP concentrations than do lean tissues such as breast muscle; Table VIII-3), a determination of both WP and lipid content of the tissue samples is in progress. To date we have analyzed five of the ducks. If WP levels are correlated with the lipid contents of the tissues, we may be able to use what is known about other highly lipid-soluble toxicants and their transmission up the food chain to predict the effect of WP in the food chain.

*Table VIII-5. Analysis of WP in tissues of predators or predator eggs collected during May or June 1991 in Eagle River Flats.*

Prey	Source	Sample	Concentration ( $\mu\text{g/g}$ wet tissue)
Bald eagle (immature female)	Found dead in flats	Fat	0.060
		Skin	0.010
Herring gull (2)	Shot in Area C	Fat	0.0
		Skin	0.0
Herring gull eggs (3)	Collected from two nests in Area D	Entire egg contents	0.003

### Predator Tissues

In late May an immature bald eagle carcass was collected in Area A. Fatty tissues of this eagle contained WP (Table VIII-5). This immature female apparently did not die of a chronic condition, as it contained large quantities of adipose fat. In addition a mature bald eagle was seen exhibiting abnormal behavior on 28 and 29 May. It was approached to within 50 m and ran into a drainage ditch with its wings dragging. Eventually it was able to fly, and we were not able to confirm the cause of its initial inability to fly.

Three herring gull eggs were collected in May and June 1991 from three nests in ERF (two in Area D and one in Area C). One of these eggs contained a small quantity of WP (Table VIII-5). In August and September, two herring gulls were killed in ERF. Neither of these birds contained WP, and we do not know whether the gulls had eaten ducks at ERF. Additionally the gull collected in September was likely not eating many ducks as there were almost no dead ducks seen in the flats. Based on the single gull egg with WP, there is some indication that WP moved from ducks to gulls and to their eggs. This emphasizes the stability of this toxicant and, at least with respect to bioaccumulation, its similarity with other lipid soluble toxicants.

### DISCUSSION AND CONCLUSIONS

These data support the hypothesis that predators can be poisoned by ingesting ducks and other waterbirds containing WP, but the risk of poisoning

is not known. WP was found in tissues of ducks and other species, as well as in one of the predators feeding on the poisoned ducks. Generally WP was associated with fatty tissues, including skin and adipose fat. To date, except for the WP-containing eagle carcass, we have little evidence of toxicity to predators of ducks.

Of particular concern is the effect on a predator, such as an eagle or other large species, that ingests an intact gizzard and its contents of WP particles. In some duck gizzards, milligram quantities of WP are present. If the lethality of WP is in the range of 1 mg/kg of body weight for a wide range of predators, then the ingestion of a single, highly contaminated gizzard could be lethal. The lower concentrations of WP in the tissues of poisoned ducks makes ingestion of these tissues a more unlikely source of toxicity to a predator. It is not known, however, if the rate of accumulation of WP is greater than its rate of detoxification or elimination by the predator.



## SECTION IX. HUMAN HEALTH RISK

## INTRODUCTION

Since waterfowl displaying early symptoms of WP poisoning have been observed to fly, the potential for these birds leaving the flats is a concern from a human health risk standpoint. Because of this concern, Alaska state epidemiologist John Middaugh issued a warning in September 1991 (Price 1991) to hunters not to take sick or dead ducks in Cook Inlet. Meanwhile, the U.S. Army Environmental Hygiene Agency (AEHA), in a memorandum to USATHAMA on July 24, 1991, described a statistical sampling plan for hunter-harvested ducks to assess the exposure risk to hunters in neighboring Cook Inlet salt marshes. Following their recommendations, on the opening day of hunting season, over 300 gizzards from hunter-harvested ducks were collected by personnel from the Alaska Department of Fish and Game and U.S. Fish and Wildlife Service for WP analysis. Collections were made from Palmer Hay Flats, Goose Bay, the Anchorage Coastal Wildlife Refuge and Susitna Flats (Figure I-1). The gizzards were primarily from dabbling ducks such as mallards, northern pintails, green-winged teal, northern shovelers and American wigeon (Table IX-1). For most birds, a skin or fat sample was also taken. A limited number of gizzards from diving ducks were also collected.

*Table IX-1. Hunting areas and species of dabbling ducks from which gizzards were collected and analyzed for WP.*

	Mallard	Pintail	GW Teal	Shoveler	Wigeon	Other	Total
Palmer Hay Flats							
Rabbit Slough	6	23	17	6	12	5	69
Cottonwood Creek	37	19	11	7	6	15	95
Knik River	11	15	2	5	6	8	47
Anch. Coastal Wildf. Ref.	26	2	14	4	9	0	55
Goose Bay	9	2	1	0	1	0	13
Susitna Flats							
Susitna River	16	3	0	0	0	0	19
Little Susitna River	2	3	2	0	0	0	7
<b>Total</b>	<b>107</b>	<b>67</b>	<b>47</b>	<b>22</b>	<b>34</b>	<b>28</b>	<b>305</b>

## METHOD FOR SCREENING OF GIZZARDS FOR WP CONTAMINATION

Following collection in the field, the gizzards were frozen and shipped to CRREL, where they were analyzed for WP. Our plan was to test the gizzard contents and, if WP was found, to analyze the fat or skin samples as well. We chose to analyze the gizzard contents first because we have found WP in the gizzard contents of every bird found dead or observed to die at ERF. While we do not know the residence time of WP in the gizzard, the analytical method as outlined below is sensitive enough to detect 20 ng (or 0.00002 mg) of WP in the gizzard contents. Thus, even a minute quantity remaining in the gizzard will be detected. We did not analyze the fat or skin from each bird because the chromatographic column used in the analysis degrades in performance with each injection of fat extract. Thus, the column would have to be changed frequently, adding to the time and expense required for the analysis.

Each gizzard was defrosted overnight in a cooler. Then a razor blade was used to slice the gizzard open. The gizzard contents were scrapped with a spatula into a preweighed vial containing 5 mL of isooctane. The vial was reweighed and the weight of the gizzard contents obtained by difference. The gizzard was rinsed with distilled water, and this rinse water was added to the vial with the scrapings. The sample was vortex-mixed for 30 s and then shaken overnight. The isooctane extract was analyzed by gas chromatography using the same parameters described previously in this report.

## RESULTS AND DISCUSSION

WP was not detected in the gizzard contents of any duck.

As outlined in the AEHA memorandum, a binomial distribution can be used to calculate the probabilities that a certain proportion of the duck population in neighboring salt marshes is contaminated with WP. The estimated maximum proportion of the total population that could be contaminated varies with sample size and confidence levels (Table IX-2).

Since 305 gizzards were analyzed and no WP was detected, we can state that the proportion of contaminated ducks in the population is less than or equal to 0.010 at the 95% confidence level. In other words, the chances of

*Table IX-2. Maximum proportion of total population contaminated for various sample sizes and confidence levels for the case where no contaminated ducks are found.*

Sample size	Confidence level		
	90%	95%	99%
25	0.088	0.113	0.168
50	0.045	0.058	0.088
100	0.023	0.030	0.045
200	0.011	0.015	0.023
300	0.008	0.010*	0.015
400	0.006	0.007	0.011

\*Sample calculation:

$$(1 - 0.95) = (1 - 0.010)^{300}.$$

selecting 305 uncontaminated individuals is only 0.05 (0.99 raised to the 305 power) if 1% of the population is contaminated.

Two exposure situations can be considered: chronic and acute. We have no evidence for either situation given that no WP was detected in the gizzard contents of any duck collected from other Cook Inlet salt marshes. We can, however, calculate a worst-case estimate of human health risk based on data for five ducks observed to die with symptoms of WP poisoning in ERF in August 1991. Using data for the most commonly consumed portions of the duck (i.e. breast muscle, thigh muscle, fat and skin), an estimate was made of the amount of WP that could be ingested by eating these five contaminated birds (two green-winged teal and three pintails) (Table IX-3). When making this calculation we must stress that since hunting is not allowed in ERF these birds were not accessible to hunters.

The chronic oral reference dose (Rfd) is used to assess chronic exposure. The Rfd is an estimate of a daily exposure level that is not likely to pose a significant risk of adverse health effects. Rfd's typically are based on animal and/or human data and contain safety factors to provide an adequate margin of safety for all members of the population. The Rfd for WP has a safety factor of 1000. The chronic Rfd for WP is  $2 \times 10^{-5}$  mg/kg · day (Gordon et al. 1990).

Table IX-3. Estimate of total WP in edible tissues from five ducks that died in ERF.

	Tissue	Total tissue mass (g)	Conc. of WP ( $\mu\text{g/g}$ )	Total WP ( $\mu\text{g}$ )
Green-winged teal	Breast muscle	62.1	0.0923	5.7
	Thigh muscle	12.0	0.277	3.3
	Fat	3.1	1.57	4.9
	Skin	53.6	0.891	47.8
	Total			61.7
Green-winged teal	Breast muscle	56.5	0.00792	0.4
	Thigh muscle	12.3	0.036	0.4
	Fat	3.7	0.0901	0.3
	Skin	41.5	0.0344	1.4
	Total			2.7
Pintail	Breast muscle	129.2	0.0169	2.2
	Thigh muscle	30.3	0.0234	0.7
	Fat	26.6	0.269	7.1
	Skin	115.3	0.176	20.3
	Total			30.3
Pintail	Breast muscle	129.8	0.00867	1.1
	Thigh muscle	28.2	0.049	1.4
	Fat	13.7	0.289	4.0
	Skin	109.4	0.211	23.1
	Total			29.5
Pintail	Breast muscle	143.0	0.0128	1.8
	Thigh muscle	35.2	0.031	1.1
	Fat	1.2	0.475	0.6
	Skin	160.6	0.0108	1.7
	Total			5.2
<b>Average per duck</b>				<b>25.9</b>

For a 70-kg adult, this amount represents a daily dose of about 1.4  $\mu\text{g}$  WP/day, or, on a yearly basis, the consumption of approximately 20 contaminated ducks per year. Since it is unlikely that birds able to leave ERF would be contaminated to the levels seen in the five birds used in this estimate, and it is



unlikely that a single hunter would take this many contaminated birds, the risk of chronic exposure from hunter-harvested ducks is low.

There is no value comparable to a Rfd to assess acute exposure. Using data from accidental poisonings, the lowest recorded lethal dose of WP for humans is 1.4 mg/kg (Gordon et al. 1990). To ingest this amount of WP, a human would have to consume 3784 ducks at a single sitting.

Based on the chronic and acute human health risk assessment data, Dr. John Middaugh, Alaska State Epidemiologist, stated in a letter on 28 August 1991 to John T. Toenes, Deputy Director, DEH, that, "while the risk of adverse health effects from potential exposure to elemental phosphorus in waterfowl cannot be said to be zero, based upon evidence from available scientific data and findings of the ongoing investigation, the risk can be said to be so low as to constitute no basis for public concern."



Remediation of WP contamination generally involves the conversion of WP to phosphorus oxides, either by exposing WP to oxygen or by using chemical oxidants. Most of the reported techniques for oxidizing WP in aqueous media were developed to treat "phossey water," which forms when water is used to protect WP from the atmosphere when WP is produced or processed for munitions.

After massive fish kills in Long Harbour, Newfoundland, release of phossey water from a WP production facility into the harbor was halted, and holding ponds were constructed to contain the plant's liquid and solid wastes. Research was initiated on how to treat the pond supernatant. ERCO (Electric Reduction Company of Canada, Ltd) Industries Limited patented a method (Deshpande 1976) to treat pond supernatant with WP concentrations up to 50  $\mu\text{g/L}$  using electrolytically produced atomic oxygen to reduce WP concentrations to less than 0.1  $\mu\text{g/L}$ . Other oxidation methods, including aeration, oxygenation or the use of chemical oxidants such as sodium chlorate, sodium chlorite and sodium hypochlorite, failed to decrease WP concentrations to undetectable levels ( $<0.1 \mu\text{g/L}$ ) (Deshpande 1976). At Pine Bluff Arsenal, treatment of water (25 mg/L of WP) in a phossey water settling pond with aeration sprays was unsuccessful in reducing the concentration to 0.01 mg/L (the limiting concentration at that time for discharge into the Arkansas River) (Blumbergs et al. 1973). By 1976 the shell-filling process was changed so that the amount of water used in processing was substantially reduced. The munition rinse water is treated with ozone to convert WP to phosphorus pentoxide, which is removed by a scrubbing system. Then the ozone-treated water is recycled in a closed system (i.e. it is not discharged) (Berkowitz et al. 1981).

The residue collected over the years in settling ponds presents a serious hazardous waste problem. Anazia et al. (1991) estimated that WP-contaminated sludge accumulates at a rate of 2 million tons per year because of the lack of reliable methods to remove or recover WP from waste streams. Using 13-year-old sludge (28–31% WP) from a settling pond containing wastes from the WP-production facility in Muscle Shoals, Alabama, Anazia et al. (1991) developed a technique where up to 87% of the WP was recovered from the sludge by physical separation; then the residual material was aerated with finely divided air bubbles to oxidize some of the unrecovered WP. Physical separation involved froth flotation, a technique generally used for mineral processing. Kerosene was used to recover the WP (Anazia et al. 1991). Strong

## SECTION X. REMEDIATION TECHNIQUES: LITERATURE REVIEW AND PRELIMINARY STUDIES

### LITERATURE REVIEW

After we identified WP as the waterbird toxicant at ERF (Racine et al. 1991), we began a literature search for information on other cases of environmental contamination by WP. We were specifically interested in clean-up strategies. Since WP is stable under water (Jangaard 1972), we predict it will persist in ERF sediments and continue to poison waterbirds until remedial actions are implemented. Our objectives are to eliminate waterfowl mortality caused by WP and preserve the ERF wetland as a very productive and diverse habitat.

Case studies are published describing environmental contamination with WP (Burrows and Dacre 1973). Primarily, this contamination occurred from the release of phosphy water, containing colloidal (suspended) and dissolved WP, from WP manufacturing facilities (Long Harbour, Newfoundland, and Muscle Shoals, Alabama) and from an arsenal (Pine Bluff, Arkansas). One case study described a train derailment in which a car containing molten white phosphorus ruptured and caught fire (Scoville et al. 1989). WP contamination of US artillery training areas with related animal dieoffs has not been previously described, although it was predicted by Berkowitz et al. (1981). In Great Britain, 20 ewes and lambs died after grazing in an artillery range; phosphorus was found in the sheep viscera and in "shell holes" (Stewart and Brynmor 1930). Another case was reported in Montgomeryshire (Great Britain), where two bullocks died after grazing in a field in which a phosphorus bomb had exploded (Adams et al. 1942).

The following is a brief summary of methods developed to treat WP contamination in aqueous media. Most of the treatment strategies would not be directly applicable to ERF. ERF is an impact area containing an unknown amount of unexploded ordnance. Any remedial action undertaken at ERF will have to take into account the hazards associated with this ordnance. However, by reviewing these case studies, we may gain insight into the potential success of a proposed remediation technique.

agitation and aeration with small air bubbles failed to reduce the concentrations of unrecovered WP of the flotation tailings to U.S. EPA safety disposal limits. Tests are continuing to study the effect on the WP concentration of increasing the air flow rate and the intensity of agitation and adding oxidizing agents such as ozone or hydrogen peroxide.

There are two cases describing the remediation of contaminated sediments, one in which the contaminated sediment was removed by dredging, and the second in which some of the sediment was treated in situ. In Long Harbour, Newfoundland, contaminated sediments, with WP concentrations as high as 2900  $\mu\text{g/g}$ , were suction-dredged and placed into a 3.8-million-cubic-foot retaining pond. The pond was divided into two sections. In the first section the dredged material (1 part sediment and 10-20 parts sea water) was held for six hours for settling, then the standing water was pumped to a tank for clarification with charcoal, lime and alum. After 40 minutes the clarified water was pumped to the second section of the pond for 24 hours, prior to pumping back into Long Harbour (Idler 1969). The sediments in the ponds were not treated in any way, so this procedure simply moved contaminated sediment from one area to another where WP would do less ecological damage.

In 1986 in Miamisburg, Ohio, a tanker car containing 40,000 L of liquid WP (45°C) derailed and burst into flames next to a stream feeding the Great Miami River, which leads to the Ohio River (Scoville et al. 1989). Three lagoons (700  $\times$  100 m total area) were constructed to isolate the contaminated stream. While most of the contaminated sediment was removed and treated by exposing the sediment on an open-air pad, the sediments that could not be removed were oxidized with two treatments of 15,000 L of 8-10% hydrogen peroxide. The hydrogen peroxide was injected into subsurface sediments with a high-pressure spray system. The initial WP concentration was as high as 4500  $\mu\text{g/g}$ . Ten days after the first treatment, the concentration was reduced to 300  $\mu\text{g/g}$ . Fifteen days following the second treatment, concentrations were less than 100  $\mu\text{g/g}$ , and one year later, the concentrations were less than 4.4  $\mu\text{g/g}$ , or a 99.9% reduction from the original concentrations. No further monitoring was reported.

These case studies show that WP in aqueous media is not reduced to undetectable concentrations by simple techniques such as aeration. Treatment of

the salt marsh sediments of ERF will likely require a combination of remediation strategies.

## LABORATORY STUDIES

A series of laboratory studies were undertaken to test some potential strategies for ERF. We tested sediment drying, aerating and chemical oxidation. We also exposed some WP to room air to get a measure of its persistence.

### Drying of Sediments

One possible remediation strategy for ERF is draining highly contaminated ponds, exposing the sediments to air and allowing the sediments to dry. We performed a laboratory experiment using ERF samples collected in August 1991 to see the effect of air-drying on contaminated sediments. The conditions in the laboratory were idealized in that the sediment was allowed to dry completely. WP concentration and soil moisture were monitored with time.

### *Methods*

Four 0.5-L sediment samples (603, 532, 493 and 484) with WP concentrations of approximately 0.1  $\mu\text{g/g}$  (wet weight basis) were homogenized as much as possible by hand mixing in a glove bag filled with argon gas. After mixing, 0.5 L was removed for the aeration experiment described below, and five subsamples were taken from the remaining sediment for WP analysis to check for homogeneity. The 1.5-L composite sample was then spread to a thickness of 2.7 cm onto a piece of filter paper covering a 26-cm-diameter perforated porcelain plate and allowed to drain and air dry. Two tensiometers measured changes in the pore water tension. Samples were taken over a six-week period and were analyzed for WP; the soil moisture was also determined. Usually only one sample was taken to avoid coring or breaking up the sample, which would accelerate drying. After one week the mud was dry and hard, and the samples, which had been obtained using a plastic corer, had to be broken off. Only pieces that were freshly broken were used; no edge pieces were analyzed. After 17 days the WP concentration appeared to stabilize, and five subsamples were taken.

### Results

The concentrations of WP were computed on a dry-weight basis to allow comparisons over time as the sample dried. The initial WP concentration in the bulk sample, as determined from five subsamples, was approximately 0.1 ( $\pm 0.073$ )  $\mu\text{g/g}$ . The composite sample was not homogeneous in terms of WP concentration or soil moisture despite thorough mixing (Table X-1). As the sample dried, there was a decrease in WP concentration (Fig. X-1). Two additional subsamples were taken at 42 days and no WP was detected.

Table X-1. WP concentrations and soil moisture determined on day 0 and day 17 in an air-dried sample.

	WP concentration ( $\mu\text{g/g}$ dry wt. basis)		Soil moisture (%)	
	Day 0	Day 17	Day 0	Day 17
Subsample 1	0.043	0.008	39.8	1.1
Subsample 2	0.060	0.008	40.6	1.8
Subsample 3	0.055	0.007	38.3	1.7
Subsample 4	0.138	0.008	48.8	2.0
Subsample 5	0.213	0.009	19.0	2.2
Mean	0.102	0.008	37.3	1.8

### Discussion and Conclusions

From this study we may conclude that a contaminated pond, if drained for remediation, will have to remain drained for weeks or months. The sediment sample for the laboratory experiment was allowed to dry to a much greater degree than would be possible in situ.

### Exposure to Air

WP persisted in an ERF sediment for several days after the sediment appeared completely dry. We performed an experiment to see how long a particle of WP would persist when exposed to atmospheric oxygen. The autoignition temperature for WP in dry air is  $38.5^{\circ}\text{C}$  (Dainton and Bevington 1945), and below this temperature, WP will oxidize by a reaction that occurs in the

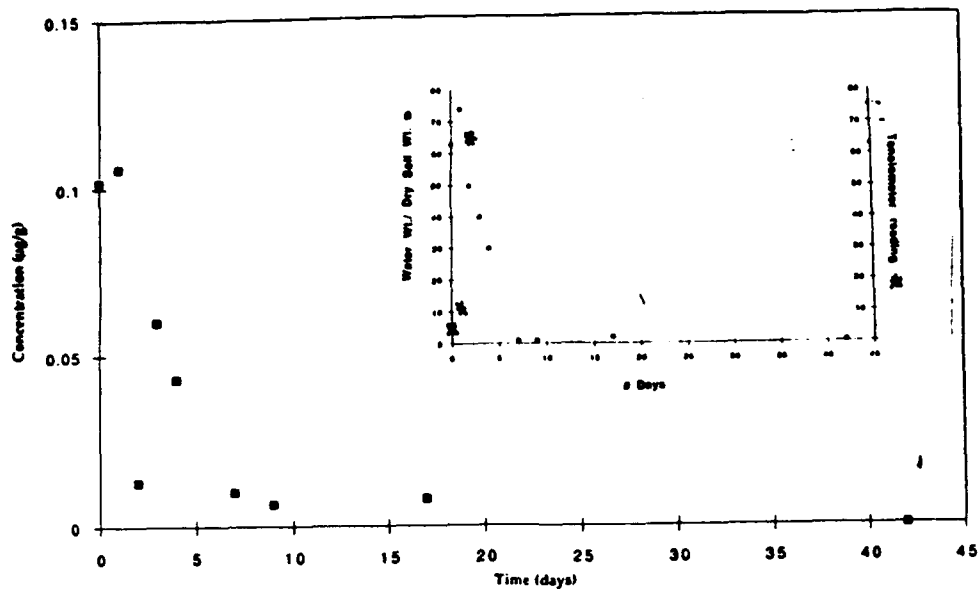

Figure X-1. Concentration of WP in an ERF sediment measured as the sample dried. Even when the sediment appeared totally dry (day 7), WP was still detectable.

vapor phase immediately adjacent to the solid phase. Thus, with time the oxidation reaction should go to completion.

#### Methods

A piece of newly cut white phosphorous (approximately 17 mg) was placed in a pre-weighed watch glass containing 500 mL of de-gassed water and weighed on a Mettler balance. (The particle was covered with the water to prevent its oxidation while it was being placed on the balance.) Drierite (anhydrous  $\text{CaSO}_4$ ) was placed in the balance enclosure to reduce the relative humidity. The weight of the watch glass and the WP particle were recorded with time, as were changes in the appearance of the phosphorus.

#### Results

After four hours all the water initially covering the WP had evaporated. The particle no longer looked vitreous and translucent, and the color changed to brown. By the following day the shape of the particle had also changed; the edges had rounded. [Dainton and Bevington (1945) recorded a similar observation and attributed the edge-rounding to surface melting from the heat



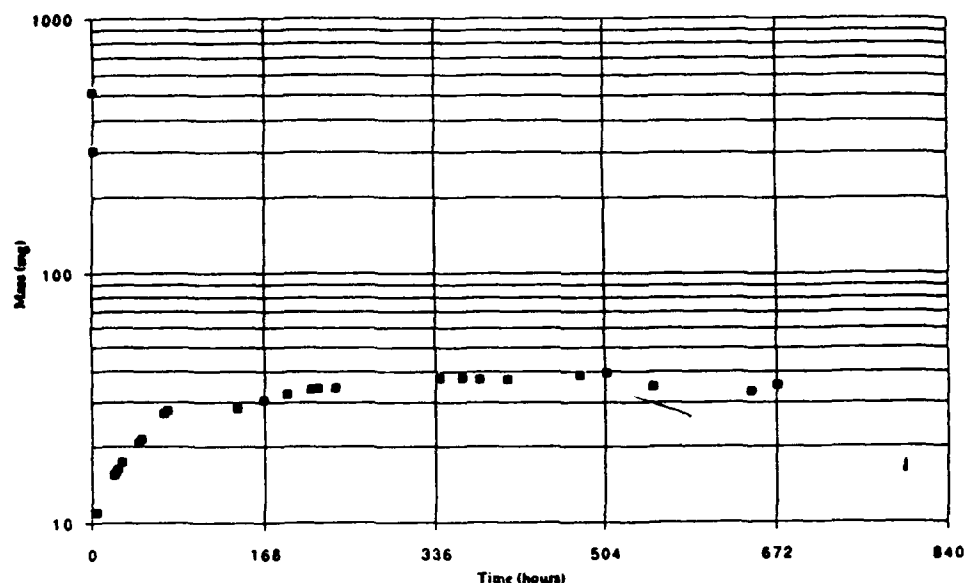

Figure X-2. Mass of white phosphorus particle and associated water with time. The large initial decrease in mass is due to the evaporation of the 500 mg of water used to cover the WP particle at the beginning of the experiment. The steady increase in weight is due to the conversion of WP to phosphorus pentoxide (a powerful drying agent). With the formation of phosphorus pentoxide, the weight increases due to moisture accretion until enough water covers the particle to prevent further oxidation.

produced by the oxidation reaction in the spatially adjacent vapor phase.] Also, by the second day a small amount of water had condensed around the base of the particle. This water is attributed to the formation of the extremely hygroscopic  $P_4O_{10}$ , the oxidation product of WP. On the fourth day only a small disk of solid material remained in the dish, and it was surrounded by a much larger amount of water. After four weeks the appearance of the phosphorus was the same as it was on the fourth day, and the weight had stabilized (Fig. X-2). The contents of the watch glass were placed in isooctane, and the isooctane was analyzed to obtain an estimate of residual WP. The surrounding water and the small disk of material remaining contained 1  $\mu$ g and 1 mg of WP, respectively.

#### Discussion and Conclusions

After four weeks of exposure to atmospheric oxygen, approximately 6% of the WP remained unoxidized. The water that was surrounding the remain-

ing WP protected it from oxidation, and, if left undisturbed, the WP would have persisted for an undetermined amount of time.

### **Aeration**

Aeration has been used to reduce WP concentrations in phosphy water and in sludge. Off-the-shelf technology such as bubblers is available for aerating ponds and potentially could be used in some areas of ERF. In the laboratory, we subjected a composite ERF sediment to active and passive aeration.

### *Methods*

A 0.5-L composite sample made from ERF sediments collected in August 1991 (603, 532, 493, and 484) was subsampled and then split into two approximately 0.25-L samples in a 0.5-L glass jar (18.5 × 19 cm). A 3-cm layer of distilled water was poured over each sample. Into one sample were placed four glass capillary tubes through which compressed air was forced. The air pressure was high enough to maintain vigorous bubbling. The other sample was left open to the air to allow passive diffusion of oxygen. Water was added daily to maintain the initial water level.

After 58 days the compressed air was turned off, and the samples were allowed to stand undisturbed for 24 hours to allow sediment to settle in the actively aerated sample. Then samples were taken for WP analysis.

### *Results*

After 58 days of exposure to air, either passively or actively, the WP concentration in the wet sediment decreased by a factor of about five from a mean initial concentration of 0.0989 µg/g (Table X-2). The mean concentration for the actively aerated samples was close to that of the passively aerated samples. After 58 days the sediment of the passively aerated sample was uniformly black, whereas the sediment of the actively aerated sample had streaks of brown. The brown color is an indication that some of the sediment was no longer anaerobic.

### *Discussion and Conclusions*

Exposure of WP-contaminated sediments to air will decrease WP concentrations, but the process is slow. For the laboratory experiment described here, active aeration of a sediment sample was not significantly more efficient at

Table X-2. WP concentrations ( $\mu\text{g/g}$ ) found after aerating for 58 days.

	Day 0 Composite	Day 58	
		Passively aerated	Actively aerated
Subsample 1	0.069	0.0181	0.0138
Subsample 2	0.053	0.0177	0.0061
Subsample 3	0.219	0.0226	0.0259
Subsample 4	0.055	0.0159	0.0151
Mean	0.0989	0.0186	0.0152
Std. dev.	0.0801	0.0028	0.0081

decreasing WP concentrations than simple passive diffusion. While aeration has been used in the treatment of phosphy water (Blumbergs et al. 1973) and sludge (Anazia et al. 1991), it has not been completely successful because the reaction tapers off and aeration alone does not decrease WP to undetectable concentrations.

### Chemical Oxidation

Hydrogen peroxide has been used to treat in-situ lagoon sediments contaminated with WP (Scoville et al. 1989). While WP does not react directly with hydrogen peroxide (Tausz and Gorlacher 1930), the hydrogen peroxide rapidly breaks down on contact with organic sediments to form oxygen and water. We treated a sample collected from ERF in August 1991 (615) with hydrogen peroxide in the laboratory.

### Methods

A 5-mL aliquot of hydrogen peroxide (Fisher 30%) and a 5-mL aliquot of water were added to each of five 50-mL glass culture tubes. Then approximately 7 g of wet sediment were added to each tube. About one minute after contact with the hydrogen peroxide solution, vigorous bubbling started and continued for at least two hours. The intensity of the bubbling diminished with time but was still visible after four hours. The color of the sediment was initially black, but after a few minutes in contact with the hydrogen peroxide, the sediment was brown, indicating it was no longer in a reduced state. For

comparison a control set was prepared in a similar manner, except 10 mL of water were added to each tube along with 7 g of sediment. After five hours both the hydrogen-peroxide-treated samples and the control samples were extracted for WP analysis.

### Results

The means for the control and the hydrogen-peroxide-treated samples were 0.316 and 0.00789  $\mu\text{g/g}$ , respectively (Table X-3). The means were compared and found to be significantly different using a t-test. The computed t value was 8.2 ( $t_{0.95;df=8} = 2.31$ ).

Table X-3. WP concentrations found after treatment with hydrogen peroxide (five replicates).

	WP concentration ( $\mu\text{g/g}$ )	
	Control	H <sub>2</sub> O <sub>2</sub>
Replicate 1	0.358	0.0133
Replicate 2	0.394	0.00377
Replicate 3	0.325	0.00402
Replicate 4	0.174	0.0107
Replicate 5	0.326	0.00768
Mean	0.316	0.00789
Std. dev.	0.0838	0.00414

### Discussion and Conclusions

In the laboratory, treatment of ERF sediments with hydrogen peroxide significantly reduced WP concentration. Only one application of hydrogen peroxide was tested; repeated applications would likely reduce the WP concentration further (Scoville et al. 1989). Whether this technique is a possible strategy for treating ERF sediment in situ requires further evaluation. Hydrogen peroxide is used as an efficient way to supply oxygen to aerobic oil degrading bacteria (McCarty 1988), so its use for environmental clean-up is not unprecedented. A literature search is underway to gain information on its environmental impact.

## USE OF EXPLOSIVES AS A REMEDIATION TECHNIQUE

### Introduction

After we uncovered the presence of WP particles in the bottom sediments of shallow waterfowl feeding ponds during the summer of 1991, Ft. Richardson DIVARTY (Division Artillery) and Training personnel suggested that the resumption of training in ERF might remediate the WP problem. They reasoned that when a point-detonating projectile from a mortar or howitzer landed in the contaminated sediments, large amounts of sediments would be thrown up into the air, where oxidation of WP could take place. Heat from the explosion might also initiate the burning of some of the WP.

We agreed to test their hypothesis and asked the Explosive Ordnance Disposal team to set a 105-mm howitzer-sized charge in a WP-contaminated pond site. The explosion of an HE (high explosives) projectile was simulated using 6 lb of explosives placed in the bottom sediment of a shallow pond in Area C, where we had found high WP contamination (6.32  $\mu\text{g/g}$ ) in May 1991 (Fig. V-4). Sample site 235 is located 75 m northwest of the Area C observation tower. At the time of the test (28 August 1991), the depth of the water over the test site was approximately 15 cm. The sediments at the bottom of the pond were soft, organic-rich silts and clays. Vegetation was sparse, consisting of scattered patches of wigeon grass.

### Methods

Prior to the test explosion the WP concentration in the bottom sediments was determined along four perpendicular axes out 16 m north, south, east and west from the detonation point as well as in the immediate vicinity of the detonation point. Composite sediment samples from the bottom surface of the pond were collected along the north, south, east and west axes, 10–13 and 13–16 m out from the detonation point. At each of the eight locations, the top 5 cm of sediment was scraped from the bottom of the pond within a 2-  $\times$  3-m sample area, placed in a large bucket and thoroughly stirred to homogenize the sediment. A subsample was taken and placed in a 16-oz I-Chem wide-mouth glass sample jar. At the detonation point a sediment core 13 cm deep was obtained to determine the vertical depth of WP contamination; compos-



*Figure X-3. Plastic sheets (2 × 3 m) placed 10–16 m from the detonation point to collect sediment blown up and out by the explosion.*

ite sediment surface samples were also obtained 1 and 2 m out from the detonation point in the four directions.

To collect the sediment thrown up and out by the explosion so it could be analyzed for WP, 2- × 3-m sheets of plastic were laid out along each of the four axes in the same locations as the pre-explosion sampling (10–13 and 13–16 m out along each of the four axes) (Fig. X-3). The plastic sheets were stretched out taut on the water surface, and the four corners of each sheet were tied to survey lath so they would stay in place.

The explosive charge used to simulate the 105-mm howitzer HE projectile was a composite charge of 6 lb of TNT and C-4 made up by the 176th EOD Detachment. The explosive charge was placed 10 cm into the bottom sediment by hand, and a ten-minute detonator cord was used to initiate the explosion.

Following the explosion, several sediment samples were collected from the rim and bottom of the crater. A composite sediment sample was also collected at a distance of 2.5 m from the crater rim. The sediment falling onto each of the 2- × 3-m plastic sheets was collected for analysis. Four people gathered up the sides of the sheet, and the sediment and water on the sheet was



*Figure X-4. Black plume produced following detonation of 6 lb of TNT and C-4 in a shallow pond in Area C.*

poured into a bucket and decanted; the remaining sediment was placed in a 16-oz I-Chem sample jar.

### Results

The explosion produced a black plume that reached an estimated height of 30 m (Fig. X-4). Sediment and water was thrown upward and outward and fell on all eight plastic sheets. The prevailing wind was from the northeast, so the most sediment fell on the sheets on the west side. A crater 2.75 m in diameter and 70 cm deep was produced.

### *Pre-explosion WP Concentrations*

Prior to the explosion the five surface samples at the center had an average WP concentration of 5.91  $\mu\text{g/g}$  (Fig. X-5a). The core sample taken at the detonation center had a very high WP concentration (59  $\mu\text{g/g}$ ) in the top 5 cm and a much lower concentration (0.034  $\mu\text{g/g}$ ) from the 5- to 13-cm depth. Along the west axis, 10–13 and 13–16 m from the center, the concentrations of WP in the surface sediments were 0.0018  $\mu\text{g/g}$  and undetectable. WP was not de-

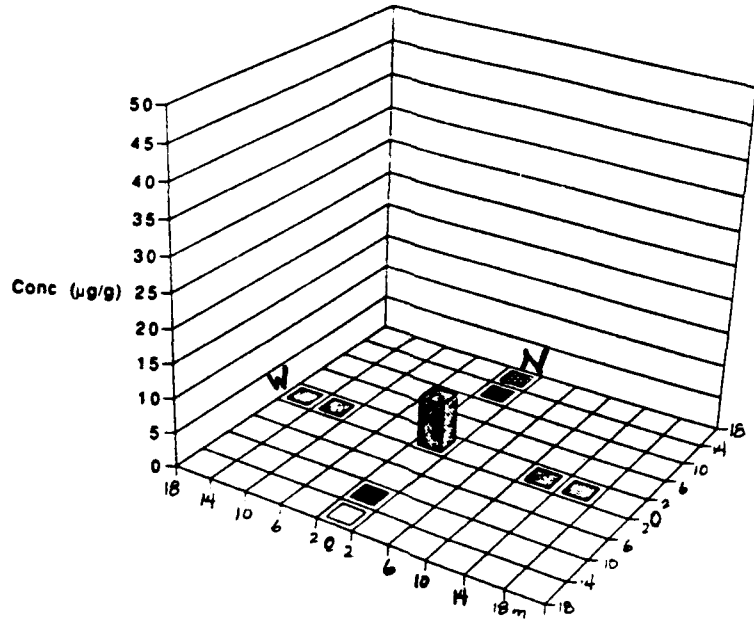

a. Before explosion.

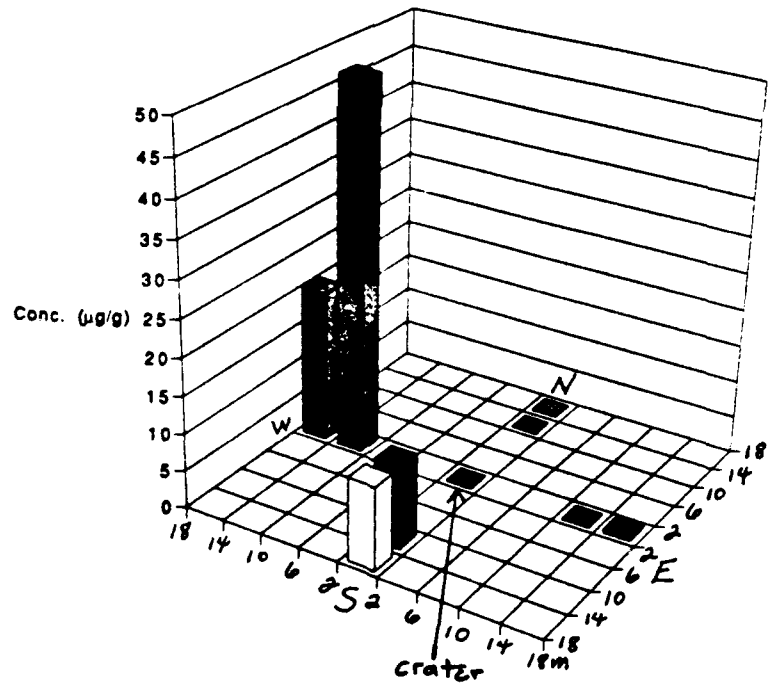

b. After explosion.

Figure X-5. WP concentrations measured in composite samples taken before and after the explosion at detonation point and 10–16 m along north, south, east and west axes.



tected along the north and east axes, and there was only a trace (less than the certified reporting limits) along the south axis.

#### *Post-explosion WP Concentrations*

Following the explosion there were dramatic increases in surface WP concentrations, particularly in the sediments collected on the plastic sheets (Figure X-5b). The concentration in the composite sample from the bottom and sides of the crater was of 0.0171  $\mu\text{g/g}$ , and the concentration in the area 2.5 m out from the edge of the crater averaged 0.113  $\mu\text{g/g}$ . Along the west axis the WP concentrations at 10–13 m and 13–16 m went from a maximum of 0.0018  $\mu\text{g/g}$  to 49.8 and 20.5  $\mu\text{g/g}$ , respectively—a four-order-of-magnitude increase in concentration. Along the south axis the sediment sample from both sheets had a concentration of 11.1  $\mu\text{g/g}$ . The WP concentrations along the north and east lines did not increase greatly after the explosion because most of the sediment ejected by the explosion landed along the west and south axes. However, along all four axes, WP concentrations were higher after than before the explosion.

#### **Discussion and Conclusions**

The explosion remediation test indicates that blowing up WP-contaminated sediments does not oxidize WP, instead WP is redistributed and scattered over a greater area by the detonation. Areas that had little or no WP prior to the explosion are now contaminated. These results are not unexpected based on the laboratory experiments described earlier in this report, which show that oxidation of WP particles in wet sediments is relatively slow.

The presence of WP in the pond sediments at ERF is evidence that WP was not totally consumed following an air or ground burst of a WP-containing projectile. During detonation the WP charge inside the projectile is blown apart, and the WP is ignited. If under these ideal conditions (unconsumed WP deposits on the ponds), it is not surprising that WP in contaminated sediments is not oxidized by the detonation of a high-explosive artillery projectile, where the sediments would be thrown up into the air for a relatively short time, along with wet mud and water from the pond. Based on these results we concluded that the resumption of summer firing would exacerbate the WP contamination.



## SECTION XI. DISCUSSION AND CONCLUSIONS

A high proportion of the sediment samples from the bottom of two of the six waterfowl feeding pond areas in ERF tested positive for WP. Mean WP concentrations in one of these ponds was significantly higher than in the others. These results from the collection and analysis of over 400 sediment samples and over 350 hours of observations by avian ecologists resulted in the hypothesis that these two ponded areas, together covering an area of 15 ha (37 acres), are the major sources of dabbling duck WP poisoning in ERF. The most heavily contaminated pond area was first identified by the avian ecologists, who noted intense duck predation by eagles, gulls and ravens in the vicinity of this pond.

The actual extent of WP contamination of non-ponded areas (i.e. mudflats, meadows and marsh) is not known since only the feeding ponds, covering an area of about 5% of the 1000-ha (2500-acre) ERF, were sampled. Although these unsampled areas receive less use by waterfowl, mudflats are used extensively by shorebirds during migrations, and in the future, areas that are now mudflat could become areas of standing water (i.e. due to earthquakes, erosion, etc.). Although a high risk of WP ingestion by duck-eating predators was confirmed along with WP-poisonings of shorebirds (particularly phalaropes), the effects of WP on other salt marsh food chains (invertebrates and fish) is unknown.

The WP particles in the sediments range in size from very small (<0.1 mm), which can become suspended in the water column, to larger particles of about 1 mm buried up to 20 cm deep in the sediments. There is evidence that the very small particles are abundant in contaminated ponds while the large particles are few. The WP mass of each particle (or dose to a bird ingesting one of these particles) ranges from 0.0001 mg for the small particles up to 3.4 mg for the large particles. Ducks feeding in the bottom sediments probably ingest these particles as they feed on food items such as seeds and invertebrates. Since a lethal dose of white phosphorus is on the order of 1 mg/kg of body weight, the ingestion of one particle can be fatal to a small duck (0.25 kg) such as a green-winged teal. Whether the very small particles (<0.1 mm) and sed-

iment concentrations ( $<0.001 \mu\text{g/g}$ ) represent a hazard to waterbirds or aquatic invertebrates is uncertain.

Although the two pond areas of major contamination are in artillery target areas, as evidenced by the numerous craters, the mechanisms by which WP entered the sediments are not known (i.e. airburst smoke clouds, groundbursts, dud leakage or delayed detonation in sediments). WP may also be indirectly deposited in the pond sediments by birds that ingest WP in a contaminated area and then fly to uncontaminated areas, where they die and decompose, with resulting WP deposition. Evidence for this mechanism includes:

- WP was found in the tissues of four green-winged teal harvested while flying in ERF and in two ducks found dead 250 m from ERF;
- Some of the uncontaminated ponds where carcasses are found are too deep for dabbling ducks such as green-wing teal to feed; and
- Samples of tissue from floating duck carcasses in advanced stages of decomposition still contained significant WP levels.

Although poisoned ducks can fly short distances within ERF and just beyond its edge, long-distance transport of WP to other Cook Inlet salt marshes apparently did not occur during the 1991 fall hunting season based on the analysis of 305 gizzards from hunter-harvested ducks.

A large percentage of the dead and disabled waterfowl from WP poisoning are partially or completely eaten by predators (eagles, ravens, gulls) on or outside ERF, resulting in high risks of WP poisoning to predators. The risk is particularly high if the gizzard contents are ingested by the predator. Tissues of a dead eagle and a herring gull egg collected from ERF tested positive for WP. Since neither eagles nor gulls feed in the sediments and both feed on duck carcasses, we conclude that WP can be transferred from one trophic level to another via predation. WP appears to be stable in fat-containing tissues in a way similar to DDT and other well-known food chain contaminants.

Previous to our work at ERF, WP was thought to be non-persistent in the environment because it is thermodynamically unstable in the presence of oxygen. However, the wet fine-grained clays and silts of ERF, even on non-flooded mudflats, remain sufficiently wet and anaerobic to prevent oxidation and sustain storage of WP particles. Most documented cases of WP environmental contamination and toxicity to biota involve colloidal forms (small particles suspended in water) of WP generated in the manufacturing of WP

and WP munitions. Existing remediation techniques are therefore not easily applied to the WP contamination in ERF sediments and, for the most part, were unsuccessful at reducing WP to undetectable concentrations in laboratory tests. Since WP is so stable in saturated sediments, capping or covering contaminated areas to make the WP particles inaccessible to sediment-feeding waterfowl may be the most feasible strategy. Recently developed geotextile fabrics placed over the bottom of contaminated ponds may be useful for this purpose. Geotextiles are "woven or nonwoven fabric manufactured from synthetic fibers or yarns that are designed to serve as a continuous membrane between soil and aggregate in a variety of earth structures." To maintain these areas as waterfowl habitat, a geotextile that permits plant growth while maintaining a barrier to WP particles would be ideal.

Whatever remediation techniques are used, it will be important to monitor and measure relative changes in mortality rates using methods developed here.

The major conclusions of the report are:

- Reliable analytical methods (solvent amounts, extraction times and subsample size) were developed to extract WP particulates from ERF sediment samples. In the field one 20-cm<sup>3</sup> extracted subsample from each 500-cm<sup>3</sup> jar containing the sediment sample provided a reliable determination of the presence or absence of WP but is less reliable in representing actual concentration of WP in the total 500-cm<sup>3</sup> sample.
- Procedures for processing waterfowl tissue samples were developed. WP was found in highest concentrations in the fatty tissues.
- Over 400 pond-bottom surface sediment samples were collected at 25-m intervals along transects in the six waterfowl feeding ponds in ERF (representing less than 5% of the area of ERF). The bottom sediments of two of the sampled waterfowl feeding ponds contained a high percentage of WP-positive samples. In addition the WP concentrations of samples from one of these ponds (Bread Truck Pond) were significantly higher than those from the other ponds. Area C and the Bread Truck ponds are hypothesized to be the major sources of WP poisoning in ERF.
- The bottom sediments of the two contaminated ponds in ERF likely contain a large number of very small WP particles (<80 μm) and a small number of much larger particles (1 mm). The larger particles could pro-

vide a lethal dose (around 0.25 mg) for a small duck such as a green-winged teal.

- The very small WP particles in the sediments can become suspended in the water column and could provide another source of exposure to waterbirds, fish or plankton.
- Following ingestion of WP particles, waterfowl are capable of flying to other feeding pond areas in ERF. Four green-wing teal out of 13 flying ducks harvested in ERF at the end of August contained WP.
- The mechanisms by which WP particles enter the pond sediments are unknown but could include smoke projectile air bursts or ground bursts, as well as leakage or subsurface explosion of duds. Evidence is presented that WP may be transported and redeposited in sediments from the decay of poisoned ducks.
- A method to monitor waterfowl mortality in permanent transects was tested and should be used to establish a baseline mortality index for evaluating the success of future remediation efforts. Observations of dying ducks and predation on them led to the discovery of the Bread Truck Pond as a major source of WP poisoning. Annual waterfowl mortality in ERF probably exceeds 2000 waterfowl and involves shorebirds as well as ducks and swans.
- Predators in ERF such as eagles, ravens and gulls are ingesting WP-contaminated duck tissues and are likely at risk. The tissues of a dead eagle and a seagull egg contained WP.
- Human health risks through consumption of ducks shot in nearby Cook Inlet marshes were found to be minimal based on the analysis for WP in over 300 hunter-harvested duck gizzards collected in September 1991.
- WP is relatively stable in wet ERF sediments and in the fatty tissues of WP-poisoned waterfowl.
- No standard remediation strategies for oxidizing WP particles in pond sediments have been developed. Sediment drying and the use of hydrogen peroxide was tested on ERF sediments in the laboratory with some success. Covering of the particles may be necessary.
- A test detonation of a high-explosive projectiles charge in WP-contaminated ERF sediments did not reduce WP concentrations and would likely exacerbate the contamination problem.

LITERATURE CITED

Adams, S.H., R. O. Davies and W.M. Ashton (1942) Phosphorus poisoning. *Agric. Jrl. Min. Agric.*, 49(1): 61-62.

Addison, R.F. and R.G. Ackman (1970) Direct determination of elemental phosphorus by gas-liquid chromatography. *Journal of Chromatography*, 47: 421-426.

Anazia, I.J., J.-O. Jung and J. Hanna (1991) Recycling and detoxification of phosphorus sludge. Proceedings of National Research and Development Conference on the Control of Hazardous Materials. February 20-22, 1991, Anaheim, CA. Sponsored by Hazardous Materials Control Research Institute.

Batten, A.R., S. Murphy and D.F. Murray (1978) Definition of Alaskan coastal wetlands by floristic criteria. Final Rept. EPA 80496501, Corvallis Environmental Res. Lab. Oregon.

Beeftink, W.G. (1977) The coastal marshes of western and northern Europe. Chapter 6 in *Wet Coastal Ecosystems* (V.J. Chapman, ed.). Elsevier, Amsterdam.

Berkowitz, J.B., G.S. Young, R.C. Anderson, A.J. Colella, W.J. Lyman, A.L. Preston, W.D. Steber, R.G. Thomas and R.G. Vranka (1981) Occupational and environmental hazards associated with the formulation and use of white phosphorus-felt and red phosphorus-butyl rubber screening smokes. U.S. Army Medical Research and Development Command, Fort Detrick, Frederick, MD 21701.

Bligh, E.G. and W.J. Dyer (1959) A rapid method of total lipid extraction and purification. *Canadian J. Biochem. and Physiology*, 37: 911-917.

- Blumbergs, P., R.C. Gillmann, R. Gault, D.L. Hatto, A.B. Ash and C.L. Stevens (1973) Chemical process studies for commercially unavailable materials. Edgewood Arsenal Contract Report EACR 1510-2. Edgewood Arsenal, MD 21010.
- Burrows, D. and J.C. Dacre (1973) Mammalian toxicology and toxicity to aquatic organisms of white phosphorus and "phossy water," a waterborne munitions manufacturing waste pollutant—A literature review. U.S. Army Medical Research and Development Command. Washington, D.C. 20315
- Chapman V.J. (1977) Wet coastal ecosystems. In *Ecosystems of the World 1* (D.W. Goodall, ed.). Elsevier, Amsterdam.
- Coburn, D.R., J.B. DeWitt, J.V. Derby and E. Ediger (1950) Phosphorus poisoning in waterfowl. *J.Am. Pharmaceutical Assoc.*, 39: 151-158.
- Cragin, J.H. (1984) Snow chemistry of obscurants released during Snow-Two/Smoke Week VI. Snow Symposium IV. USACRREL, Hanover, NH. August 1984. CRREL Special Report 84-35.
- Dainton, F.S. and J.C. Bevington (1945) The oxidation and inflammation of yellow phosphorus. *J. Chemical Society*, 377-388.
- Day, J.W., C.A.S. Hall, W.M. Kemp and A. Yanez-Arancibia (1989) *Estuarine Ecology*. 558 p., J. Wiley and Sons, New York.
- Deshpande, A.K. (1976) Oxidation of phosphorus in aqueous medium. U.S. Patent 3,971,707, July 27, 1976.
- Dodson, S.I. and D.L. Egger (1980) Selective feeding of red phalaropes on zooplankton of arctic ponds. *Ecology*, 61: 755-763.
- Dyer, W.J., D.F. Hiltz, R.G. Ackman, J. Hingley, G.L. Fletcher, and R.F. Addison (1972) Stability of elemental phosphorus in edible muscle tissue of cod during processing including icing, freezing, and thawing, frozen



## Literature Cited

---

- storage, salting, and cooking. *Journal Fisheries Research Board of Canada*, 29(7): 1053-1060.
- Earle, J.C. and K.A. Kershaw (1989) Vegetation patterns in James Bay coastal marshes. III. Salinity and elevation as factors influencing plant zonations. *Can. J. Bot.*, 67: 2967-2974.
- ESE (1990) Eagle River Flats expanded site investigation. Fort Richardson, Alaska. Environmental Science and Engineering, Inc. Final Technical Report. Data Item A011. U.S. Army Toxic and Hazardous Materials Agency, Aberdeen, MD.
- Fletcher, G.L. (1971) Accumulation of yellow phosphorus by several marine invertebrates and seaweed. *J. Fish. Res. Bd. Canada*, 28: 793-796.
- Fletcher, G.L. (1973) The acute toxicity of a yellow phosphorus contaminated diet to brook trout (*Salvelinus fontinalis*). *Bull. of Env. Cont and Toxicology*, 10: 123-128.
- Friend, M., ed. (1987) Lead poisoning. Chapter 18 in *Field Guide to Wildlife Diseases*. National Wildlife Health Center, Madison, Wisconsin
- Evans, C.D., E. Buch, R. Buffler, G. Fisk, R. Forbes and W. Parker (1972) The Cook Inlet environment, a background study of available knowledge. Anchorage, Alaska: Resource and Science Center, University of Alaska.
- Glooshenko, W.A. and K. Clark (1982) The salinity cycle of a subarctic salt marsh. *Nat. Can. (Que.)*, 109: 483-490.
- Gosselink, J.G. (1984) The ecology of delta marshes of coastal Louisiana: A community profile. U.S. Fish and Wildlife Service, Biological Services. FWS/OBS-84/09, Washington, D.C. 134 p.
- Gordon, L. W.R. Hartley, W.C. Roberts and K. Khanna (1990) Health advisory on white phosphorus. Office of Drinking Water, U.S. Environmental Protection Agency, Washington, D.C. 20460.

- Grant, C.L. and P.A. Pelton (1974) Influence of sampling on the quality of analyses with emphasis on powders. In *Advances in X-Ray Analysis*. C. L. Grant, Ed. Plenum Press. New York, New York. p. 44-67.
- Grey, B.J., and D.K. MacKay (1979) Aufeis (overflow ice) in rivers. Canadian Hydrology Symposium: 79 - Cold Climate Hydrology, National Research Council of Canada, Ottawa, p. 134-165.
- Humburg, D.D. , D. Graber, S. Sheriff and T. Miller (1984) Estimating autumn-spring waterfowl nonhunting mortality in northern Missouri. In *Lead Poisoning in Wild Waterfowl A Workshop*. 3-4 March, Wichita, KS by Coop Lead Poisoning Control Information Program. Nat. Wildlife Fed. Washington, D.C. 139 p.
- Idler, D. R. (1969) Coexistence of a fishery and a major industry in Placentia Bay. *Chem Can.*, 21: 16-21.
- Jangaard, P.M. (1972) Effects of elemental phosphorus on marine life. Atlantic Regional Office, Research and Development, Fisheries Research Board of Canada, Halifax, Nova Scotia. Circular No. 2. November 1972.
- Jeffries, R.L. (1977) The vegetation of salt marshes at some coastal sites in arctic North America. *Journal of Ecology*, 65: 661-672.
- Jenkins, T.F. and C.L. Grant (1987) Comparison of extraction techniques for munitions residues in soil. *Analytical Chemistry*, 59: 1326-1331.
- Jenkins, T.F., M.E. Walsh, P.W. Schumacher, P.H. Miyares, C.F. Bauer and C.L. Grant (1989) Liquid chromatographic method for the determination of extractable nitroaromatic and nitramine residues in soil. *Journal of the AOAC*, 72: 890-899.
- Jenkins, T.F. and M.E. Walsh (1987) Development of an analytical method for explosive residue in soil. U.S. Cold Regions Research and Engineering Laboratory, Hanover, NH. CRREL Report 87-7.

## Literature Cited

---

- MacDonald, K.B. (1977) Plant and animal communities of Pacific North American salt marshes. In *Wet Coastal Ecosystems* (V.J. Chapman, ed.) p. 167-191. Elsevier, Amsterdam.
- McCarty, P.L. (1988) Bioengineering issues related to in situ remediation of contaminated soils and groundwater. In *Environmental Biotechnology*. (G.S. Omenn, ed.), p. 143-162.
- Mitsch, W.J. and J.G. Gosselink (1986) *Wetlands*. Van Norstrand Reinhold, New York. 537 p.
- Neiland, B.J. (1971) Survey of vegetational and environmental patterns of the Chickaloon Flats, Kenai Peninsula, Alaska. Unpublished report to Kenai Natl. Moose Range U.S.D.I.
- NOAA (1989) U.S. Dept of Commerce, National Climate Center, Federal Building, Asheville, NC 28801.
- Nudds, T.D. and J.N. Bowlby 1984. Predator-prey size relationships in North American dabbling ducks. *Can. J. Zool.*, 62: 2002-2008.
- Patrick, W.H., Jr., and R.D. DeLaune (1977) Chemical and biological redox systems affecting nutrient availability in the coastal wetlands. *Geoscience and Man*, 18: 131-137.
- Pearson, J.G., E.G. Bender, D.H. Taormina, K.L. Manuel, P.F. Robinson and A.E. Asiki (1976) Effects of elemental phosphorus on the biota of Yellow Lake, Pine Bluff Arsenal, Arkansas, March 1974 - January 1975. Edgewood Arsenal Technical Report EO-TR-76077.
- Pomeroy, L.R., L.R. Shenton, R.D. Jones and R.J. Reimold (1972). Nutrient flux in estuaries. In *Nutrients and Eutrophication* (G.E. Likens, ed.). Am. Soc. Limnol. Oceanogr. Spec. Symp. Allen Press, Lawrence, KS, p. 274-291.

- Pourbaix, M. (1966) *Atlas of Electrochemical Equilibria in Aqueous Solutions*. Pergamon Press, Oxford.
- Price, N. (1991) Phosphorus-tainted ducks pose low health risk on dinner table. *Anchorage Times*. 27 September 1991, page B-5.
- Racine, C.H., M.E. Walsh, C.M. Collins, D.J. Calkins and B.D. Roebuck (1991) Waterfowl mortality in Eagle River Flats, Alaska: The role of munition compounds. U.S. Army Cold Regions Research and Engineering Laboratory, Hanover, NH. Final Report to USATHAMA. CETHA-IR-CR-91008
- Rosenberg, D.H. (1986) Wetland types and bird use of Kenai Lowlands. Unpub. Rept. U.S. Fish and Wildlife Service, Special Studies, Anchorage, AK.
- Russell, E.J. (1903) The reaction between phosphorus and oxygen. *Journal Chemical Society*, 83: 1263-1284.
- Scoville, W., S. Springer and J. Crawford (1989) Response and cleanup efforts associated with the white phosphorus release, Miamisburg, Ohio. *Journal of Hazardous Materials*, 21: 47-64.
- Small, J.B. and L.C. Wharton (1972) Vertical displacements. In *The Great Alaska Earthquake of 1964. Volume II, Seismology and Geodesy*. National Academy of Sciences, Washington, D.C., p 449-458.
- Snelson, A. (1980) Personal communication as reported in Berkowitz et al. (1981).
- Snow, A.A. and S.W. Vince (1984) Plant zonation in an Alaskan salt marsh. I. Distribution, abundance and environmental factors. *Journal of Ecology*, 72: 669-684.
- Spanggard, R.J., R. Rewick, T.-W. Chou, R. Wilson, R.T. Podoll, T. Mill, R. Parnas, R. Platz and D. Roberts (1985) Environmental fate of white

## Literature Cited

---

phosphorus/felt and red phosphorus/butyl rubber military screening smokes. SRI International, Menlo Park, CA 94025. ADA176922.

Stecher, P.G. (ed) (1968) *The Merck Index*. 8th edition, Merck and Co., Inc., Rahway, NJ, p. 824.

Stewart, W. L. and T. Brynmor (1930) A curious case of phosphorus poisoning in sheep. *Jour. Min. Agric.*, 37: 56-69.

Sullivan, J.H., H.D. Putnam, M.A. Keirn, B.C. Pruitt, Jr., J.C. Nichols and J.T. McClave (1979) A summary and evaluation of aquatic environmental data in relation to establishing water quality criteria for munitions-unique compounds. Part 3: White phosphorus. Water and Air Research, Inc., Gainesville, FL 32602. ADA083625.

Tausz, J. and H. Gorlacher (1930) The oxidation of phosphorus by oxygen. *Z. anorg. allgem. Chem.*: 190:95-119. (Chemical Abstract 24:4476).

Teal, J.M. (1986) Tidal salt marshes of eastern North America: The ecology of the low salt marsh. U.S. Fish and Wildlife Service, Biological Services. Washington, D.C.

Tweten, R. (1989) Eagle River Flats waterfowl mortality investigation progress report. U.S. Fish and Wildlife Service, Tudor Rd. Anchorage, AK. Unpublished.

USGS (1990). Hydro Data, Vol. 2.0. USGS Daily Values/Western: Period of Record. CD ROM. US West Optical Publishing Co.

Van Voris, P. M.W. Ligothke, K.M. McFadden, S.W. Li, B.L. Thomas, D.A. Cataldo, T.R. Garland, J.K. Fredrickson, R.M. Bean and D.W. Carlile (1987) Evaluate and characterize mechanisms controlling transport, fate and effects of army smokes in the aerosol wind tunnel: Transport, transformations, fate, and terrestrial ecological effects of red phosphorus-butyl rubber and white phosphorus obscurant smokes. PNL-6071. Pacific Northwest Laboratory, Richland, Washington 99352.

Van Wazer, J.R. (1958) *Phosphorus and Its Compounds, Volume I: Chemistry*, Interscience Publishers, Inc., New York.

Vince, S.W. and A.A. Snow (1984) Plant zonation in an Alaskan salt marsh. I. Distribution, abundance and environmental factors. *J. of Ecology*, 72: 651-667.

USATHAMA (1990) U.S. Army Toxic and Hazardous Materials Agency Quality Assurance Program. Aberdeen Proving Ground, MD. USATHAMA PAM 11-41.

APPENDIX A. WATERFOWL CENSUS 1991

Waterbird Utilization of Eagle River Flats  
April-October 1991

by

William Dean Eldridge  
U.S. Fish and Wildlife Service  
1011 E. Tudor Road  
Anchorage, Alaska

Key Words: Eagle River Flats, Cook Inlet, aerial survey, ducks,  
geese, swans, waterbirds, migration

December 9, 1991

## Introduction

The U.S. Fish and Wildlife Service (Service) and the U.S. Army, Fort Richardson, conducted aerial waterbird surveys of Eagle River Flats (ERF) during spring, summer and fall of 1991, as part of the ongoing waterbird mortality studies on ERF, sponsored by the United States Army. The purpose, history, and status of this investigation have been presented elsewhere (Tweeten 1989, ESE 1990, Cold Regions Research and Engineering Laboratory (CRREL) 1991). The objective of the 1991 aerial waterbird survey was similar to that of previous aerial surveys of ERF, initiated in 1988: To monitor waterbird abundance and distribution on ERF during spring, summer, and fall.

## Study Area

Eagle River Flats is a salt marsh complex comprising 2,500 acres located along the southern side of upper Cook Inlet, approximately 10 km east of Anchorage (Figure 1). A detailed description of the area is presented elsewhere (ESE 1990, CRREL 1991).

## Methods

Aerial surveys of ERF were flown from April through October, 1991. A total of 33 surveys were conducted, with increased frequency in spring and fall. Surveys were flown using fixed-wing aircraft at an airspeed of 70-90 mph and at an altitude of 150 to 300 feet. Total coverage of ERF was obtained on each survey. Numbers of waterbirds were counted or estimated and recorded by species or species group with a cassette tape recorder. All species of birds were recorded during Service surveys and the U.S. Army recorded all waterfowl, eagles, and cranes. As in 1990 (CRREL, 1991), waterfowl numbers were classified by location on ERF in 1991 using the broad study zones, areas A,B,C and D (Figure 1). Tide, snow, ice and water conditions were noted. When bald eagles were present, a perimeter survey of the treeline was flown to count perched eagles. Tapes were transcribed in the office and entered in a computer.

## Results

Moisture Conditions. Breakup in 1991 was somewhat delayed over 1990. On the first aerial survey, 18 April, ice and snow covered 95% of ERF compared to 50% on 17 April, 1990. By 30 April, 40% of ERF was still covered by snow or ice, and the remainder was flooded with meltwater. Eagle River Flats was essentially snow free by 26 April in 1990, but did not become snow free until



between 3-10 May, 1991. Coastal conditions in Cook Inlet varied somewhat from recent years in that the coastal fringe adjacent to the inlet remained iced over through April and into May, while more inland habitats opened up. This condition was less pronounced on ERF, but definitely affected habitat use by waterbirds elsewhere in the inlet, and probably influenced utilization of ERF.

As in previous years, much of Area A on ERF dried up during summer, and water levels dropped throughout ERF. Rains in August replenished water levels to some extent, however, flood tides did not occur until mid-September. In general, the fall was probably drier than recent years. Skim ice covered most of ERF by 8 October, but melted over the much of the area within a few days. The area rapidly froze again, although small open areas remained and a few ducks were still using the area on 16 October, the date of the last survey.

Migration phenology. Spring migration, particularly of geese, through Cook Inlet and ERF was probably affected by the iced shoreline conditions. Much of the preferred habitat on the Susitna Flats, Trading Bay, and Redoubt Bay was unavailable to birds through much of April, so birds tended not to stay in the Inlet long in spring. Alaska experienced a mild fall in general, and interior wetlands did not freeze over until late September or October. Therefore, many ducks, geese and swans did not concentrate in Cook Inlet to the extent that they normally do. Depending on species, migration occurred as a general mass exodus at freeze-up, or birds tended to trickle through as fall progressed. A brief description of migration and peak numbers of major waterbird species follows:

Swans. Normally utilization of ERF by tundra (Cynus colubianus) and trumpeter swans (C. buccinator) is higher in fall than spring (see CREEL 1991, Appendix 1). In 1991, more swans were observed in spring than fall (Figure 2), and more swans were observed in spring (approximately 500 at one time) than in previous years. A maximum of 250 were observed in the fall, compared to over 1,500 in other years. The lack of build up of swan numbers can probably be attributed to the mild fall weather in Alaska this year. Swans migrated through Cook Inlet in large numbers during the first 10 days in October, but did not stop or concentrate in large numbers anywhere in the Inlet, including ERF.

Geese. Snow geese (Chen caerulescens) used ERF in spring, 1991 much more than previous years, which accounts for the high numbers of geese depicted in spring in Figure 2. This is probably due to the unavailability of good habitat elsewhere in the Inlet during peak migration. Snow geese were not observed during fall surveys. Trends in numbers of Canada geese (Anser canadensis) were similar to other years, with peak numbers in the fall, however the 1991 peak was less than that of other

years. Canada geese also migrated through Cook Inlet in large numbers in early October, but did not stop or concentrate in large numbers except briefly at Chickaloon Flats and Coffee Point on the Palmer Hay Flats. Numbers of white-fronted geese (A. albifrons) were low, similar to other years, peaking in early to mid-September.

Ducks. Duck species utilizing ERF in 1991 were similar to those of previous years (Table 1). As in other years, fall numbers were higher than spring, although peak numbers counted in 1991 were less than 1990. Trends in migration phenology were very similar for 1990 and 1991 (Figure 2, CRREL 1991). As in previous years, mallards (Anas platyrhynchos), northern pintails (A. acuta), American wigeon (A. americana), green-winged teal (A. crecca) and northern shoveler (A. clypeata) were the most common duck species observed. Numbers of the most common species are depicted in Figure 2, with trends similar to those of other years.

Bald Eagles. As in previous years, bald eagles (Haliaeetus leucocephalus) were more abundant in spring than fall, although 31 were counted on October 16. Eagles appear to be concentrating feeding efforts on dead or sick waterfowl and numbers may relate to available carcasses.

Shorebirds. As in previous surveys, shorebirds were not identified to species from the air, so numbers of all species are combined. This masks differences in timing of migration by individual species, and ground observations would be required to remedy that situation. However, similar to 1990, it is clear that large numbers of shorebirds migrate through ERF in late May and again in early July (Table 1). Common species to ERF probably include least (Calidris minutilla), semipalmated (C. pusilla), and western sandpipers (C. mauri), and dowitchers (Limnodromus spp.) in addition to greater and lesser yellowlegs (Tringa spp.)

Gulls and Terns. Gull species were combined for aerial surveys, but include primarily mew gulls (Larus canus), glaucous-winged gulls (L. glaucescens) and Herring gulls (L. argentatus). As in previous years, a small colony of mew gulls was located in Area D, and small numbers of Herring gulls nested on ERF. Nesters arrived by early May and gulls were common through the summer, departing abruptly by mid September. Arctic terns (Sterna paradisaea) were common from early May to late June, as in previous years, and nested on ERF.

#### Spatial Distribution of Waterfowl on ERF

Results of the classification of waterfowl by areas A, B, C, and D of ERF are presented in Table 2.

Swans made heaviest use of area A in the spring, were not present in summer, and as in 1990, used area D the most in fall. Many more swans were classified in spring of 1991 (n=543), than in 1990 (n=42) which may explain the different pattern observed in spring.

Canada geese used area A most in the spring and fall, and areas C and D in summer. Snow geese were only observed in spring, which is typical of their migration, when they used areas A and B most.

When all ducks are considered together, areas A and C were most used in spring, area D in summer, and areas A and D in fall. Spring and summer use was similar to 1991, however fall use appeared to shift more to areas A and D in 1991 from the relatively equal distribution in 1990. As in 1990, species specific use of certain areas varied in fall (Table 2), however differences occurred between 1990 and 1991 for individual species. Green-winged teal used area C most in 1991, and area A in 1990. Mallards used area A most in 1991, but exhibited equal distribution in 1990. Northern pintails also used area A most in 1991, where area B was most used in 1990. American wigeon also used area A most in 1991, but used area D considerably more than other areas (49%) in 1990. Without statistical analysis, we do not know the significance of these differences. If real, they could likely be explained by varying water and food conditions, as well as other factors such as disturbance from humans and predators.

#### LITERATURE CITED

- Cold Regions Research Laboratory (CRREL). 1991. Waterfowl Mortality in Eagle River Flats, Alaska: the role of munitions compounds. U.S. Army Toxic and Hazardous Materials Agency Aberdeen Proving Ground, Maryland. 80pp.
- ESE (1990) Eagle River Flats expanded site investigation. Fort Richardson, Alaska. Environmental Science and Engineering, Inc. Final Technical Report. Data Item A011. U.S. Army Toxic and Hazardous Materials Agency, Aberdeen, MD.
- Tweeten, R.G. 1989. Eagle River Flats Waterfowl Mortality Investigation Progress Report. Eagle River Flats Task Force. R.G. Tweeten Project Leader, August 1989. 37pp.



Table 1. Continued.

	8/5	8/16	8/30	9/13	9/15*	9/18*	9/20	9/21*	9/22*	9/24*	9/28*	10/2	10/5*	10/6**	10/8	
<u>Swans (Cvgnus sp.)</u>	0	0	0	8	20	61	65	70	130	136	73	146	145	149	105	211
<u>Geese</u>																
Greater White-fronted Goose ( <u>Anser albifrons</u> )	0	0	55	135	70	0	0	0	0	0	0	0	0	0	0	0
Snow Goose ( <u>Chen caerulescens</u> )	0	0	0	0	0	0	0	0	0	0	0	0	0	0	0	0
Canada Goose ( <u>Branta canadensis</u> )	33	105	45	922	935	972	450	495	166	444	616	640	640	180	0	0
Subtotal Geese	33	105	100	1057	1005	972	450	495	166	444	616	640	640	180	0	0
<u>Ducks</u>																
Green-winged Teal ( <u>Anas crecca</u> )	116	198	49	220	65	0	107	20	0	105	135	70	0	0	10	10
Mallard ( <u>Anas platyrhynchos</u> )	122	51	210	334	630	0	973	940	910	625	812	265	205	0	450	450
Northern Pintail ( <u>Anas acuta</u> )	127	265	193	158	60	0	181	0	5	0	0	200	0	0	32	32
Northern Shoveler ( <u>Anas clypeata</u> )	0	2	8	0	0	0	60	0	0	0	0	5	0	0	5	5
American Wigeon ( <u>Anas americana</u> )	49	45	162	93	0	0	270	0	70	148	178	88	62	0	0	0
Canvasback ( <u>Aythya valisineria</u> )	0	0	0	0	0	0	0	0	0	0	0	0	0	0	0	0
Redhead ( <u>Aythya americana</u> )	0	0	0	0	0	0	0	0	0	0	0	0	0	0	0	0
Greater Scaup ( <u>Aythya marila</u> )	0	0	0	0	0	0	0	0	0	0	0	0	0	0	0	0
Goldeneye ( <u>Bucephala sp.</u> )	0	0	0	0	0	0	0	0	0	0	0	26	0	0	0	0
Bufflehead ( <u>Bucephala albeola</u> )	0	0	0	0	0	0	0	0	0	0	0	0	0	0	0	0
Merganser ( <u>Mergus sp.</u> )	0	0	0	0	0	0	0	0	0	0	0	0	0	0	0	0
Unknown Duck	0	0	0	0	0	0	918	0	228	28	1	0	0	420	0	0
Subtotal Ducks	414	561	622	805	755	918	1591	1188	1013	879	1125	654	687	497	497	497
<u>Other</u>																
Bald Eagle ( <u>Haliaeetus leucocephalus</u> )	0	3	3	7	0	0	3	0	0	0	2	5	11	6	3	3
Sandhill Crane ( <u>Grus canadensis</u> )	2	13	2	30	46	0	0	0	0	0	0	0	0	0	0	0
Shorebird sp.	539	157	42	5			103					25				
Gull ( <u>Larus sp.</u> )	22	18	23	32			8					2				
Arctic Tern ( <u>Arctic tern</u> )	0	0	0	0	0	0	0	0	0	0	0	0	0	0	0	0
Common Raven ( <u>Corvus corax</u> )	9	3	0	0	0	0	6	0	0	0	0	4	0	0	2	2
Northern Harrier ( <u>Circus cyaneus</u> )	0	0	1	0	1	0	0	0	0	0	0	0	0	0	0	0
Peregrine Falcon ( <u>Falco peregrinus</u> )	0	0	1	0	0	0	0	0	0	0	0	0	0	0	0	0
Osprey ( <u>Pandion haliaetus</u> )	0	0	0	0	1	0	0	0	0	1	0	0	0	0	0	0

Table 1. Continued.

	10/10*	10/12*	10/15	10/16*
Swans ( <u>Cygnus</u> sp.)	211	241	31	25
<u>Geese</u>				
Greater White-fronted Goose ( <u>Anser albifrons</u> )	0	0	0	0
Snow Goose ( <u>Chen caerulescens</u> )	0	0	0	0
Canada Goose ( <u>Branta canadensis</u> )				
Subtotal Geese	0	0	0	0
<u>Ducks</u>				
Green-winged Teal ( <u>Anas crecca</u> )	0	0	0	0
Mallard ( <u>Anas platyrhynchos</u> )	295	362	110	80
Northern Pintail ( <u>Anas acuta</u> )	0	0	2	0
Northern Shoveler ( <u>Anas clypeata</u> )	0	0	0	0
American Wigeon ( <u>Anas americana</u> )	2	0	0	0
Canvasback ( <u>Aythya valisineria</u> )	0	0	0	0
Redhead ( <u>Aythya americana</u> )	0	0	0	0
Greater Scaup ( <u>Aythya marila</u> )	0	0	0	0
Goldeneye ( <u>Bucephala</u> sp.)	0	0	0	0
Bufflehead ( <u>Bucephala albeola</u> )	0	0	0	0
Merganser ( <u>Mergus</u> sp.)	0	0	0	0
Unknown Duck	0	225	0	0
Subtotal Ducks	297	587	112	80
<u>Other</u>				
Bald Eagle ( <u>Haliaeetus leucocephalus</u> )	11	12	28	31
Sandhill Crane ( <u>Grus canadensis</u> )	0	0	0	0
Shorebird sp.				
Gull ( <u>Larus</u> sp.)				
Arctic Tern ( <u>Arctic tern</u> )				
Common Raven ( <u>Corvus corax</u> )				
Northern Harrier ( <u>Circus cyaneus</u> )				
Peregrine Falcon ( <u>Falco peregrinus</u> )				
Osprey ( <u>Pandion haliaetus</u> )				

\* Waterfowl, cranes, and eagles survey only, Bill Quirk, U.S. Army

\*\* Swan survey only, Bill Quirk, U.S. Army

Table 2. Percent of total observations\* recorded in areas A, B, C, D of Eagle River Flats (Figure 1) during spring, summer and fall for major waterfowl groups and species.

	Spring				Summer				Fall						
	A	B	C	D	(n)	A	B	C	D	(n)	A	B	C	D	(n)
Swans	84	7	6	3	(543)	0	0	0	0	(0)	12	5	1	82	(1,423)
Geese															
Can.	71	7	13	9	(1,277)	14	2	45	39	(94)	55	0	19	26	(5,237)
Snow	48	33	19	tr	(6,409)										
Ducks	37	9	33	21	(2,214)	15	18	17	50	(1,265)	37	17	16	30	(10,451)
Green-winged teal											21	6	50	23	(976)
Mallard											43	23	14	20	(5,798)
Northern pintail											48	8	28	16	(1,091)
American wigeon											35	5	12	24	(1,024)

\* Represents only observations classified by area

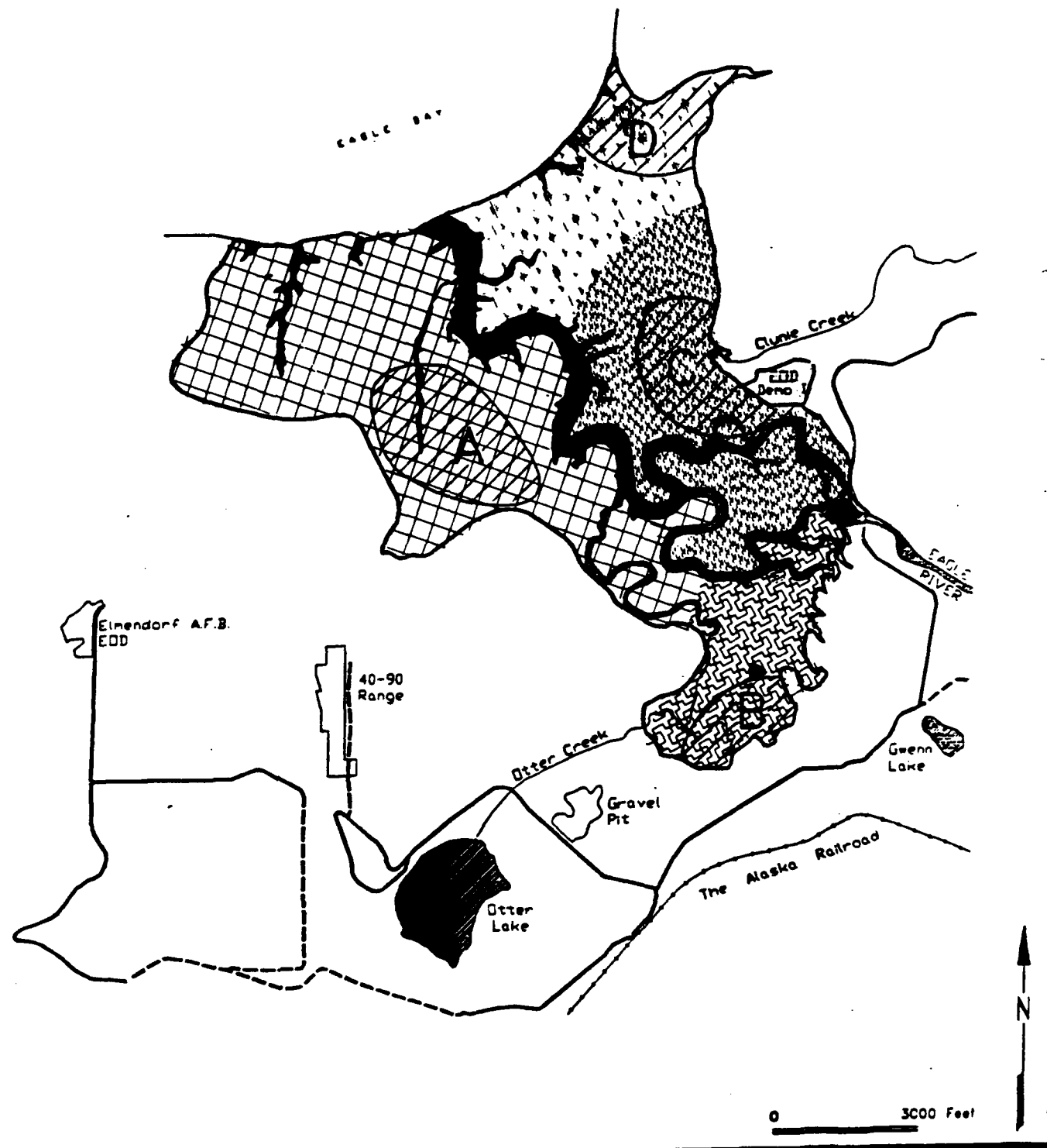
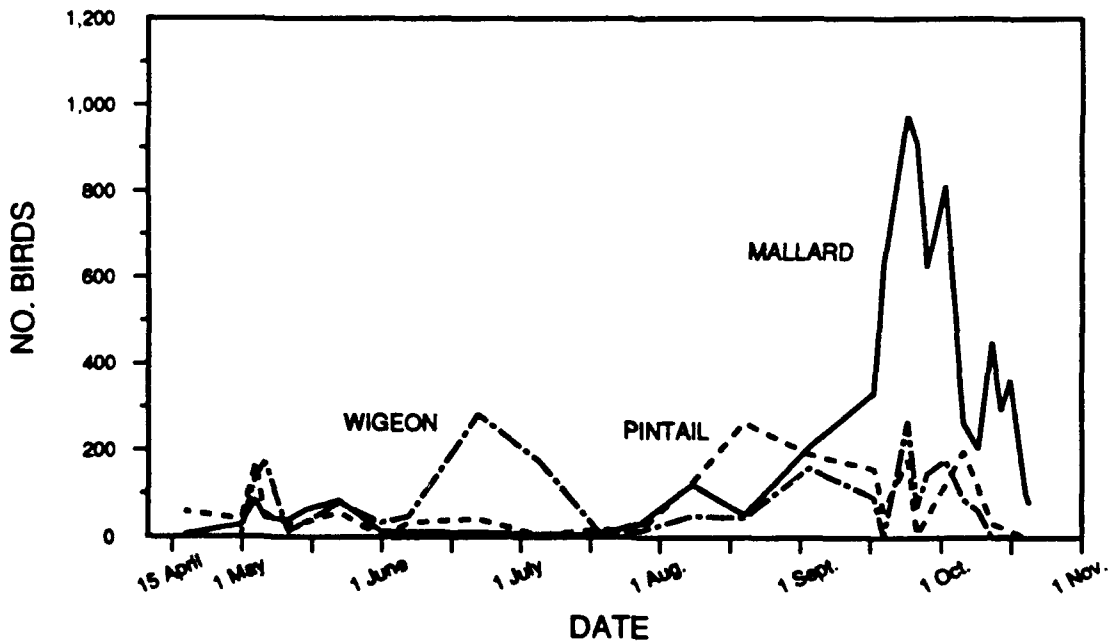
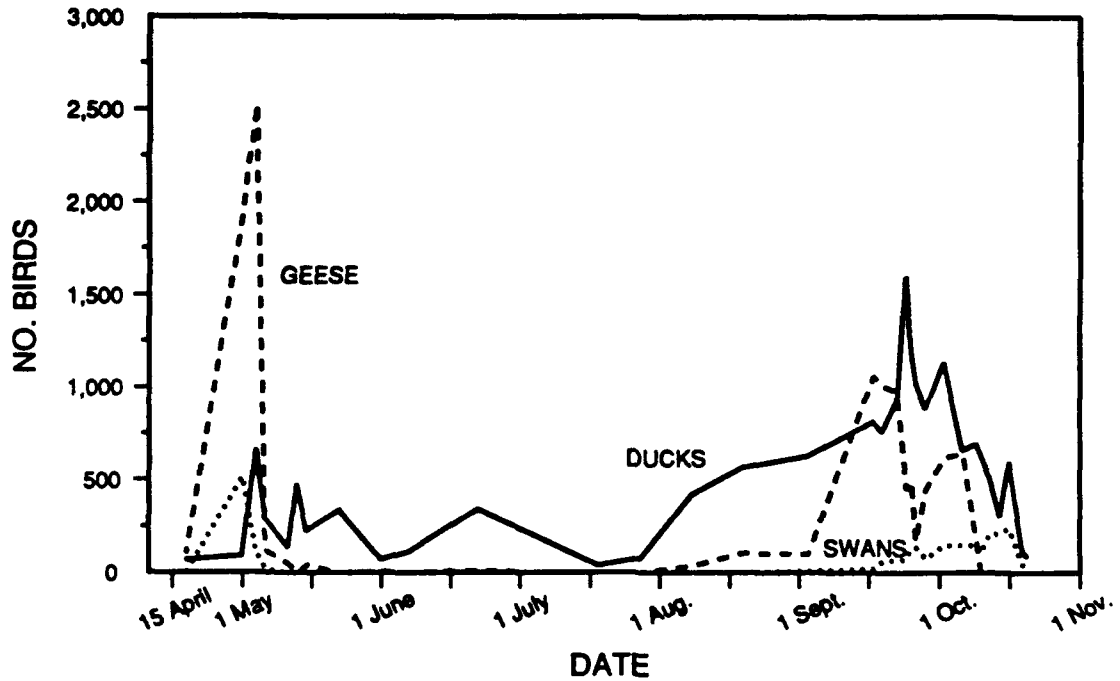

Figure 1. The Eagle River Flats study area, with zones A, B, C, and D.



Figure 2. The numbers of swans, geese, and ducks observed on Eagle River Flats during aerial surveys conducted in 1991.



**APPENDIX B.**  
**ANALYTICAL METHOD FOR WHITE PHOSPHORUS IN SOIL**  
**(KN01)**

**I. Summary**

- A. Analyte:** This method is suitable for determining white phosphorus ( $P_4$ ).
- B. Matrix:** This method is suitable for determining white phosphorus ( $P_4$ ) in wet soil or sediment.
- C. General Method:** A 10-g subsample of wet soil or sediment is placed into a 40-mL vial containing 10.0 mL of isooctane. A 5-mL aliquot of degassed water. The sample is vortex-mixed for 1 minute then placed horizontally on a platform shaker for 12 hours or overnight. The sample is then allowed to stand vertically for 15 minutes to allow phase separation. A 1.0- $\mu$ L aliquot of the isooctane layer is analyzed on a gas-chromatograph equipped with a nitrogen-phosphorus detector.

**II. Application**

- A. Tested Concentration Range:** This method was tested over the range of concentration 4.08-81.6  $\mu$ g/kg (0.00408 - 0.0816  $\mu$ g/g).
- B. Sensitivity:** The instrumental response at the calculated reporting limit was 13106 peak height units for 4.08 picograms.
- C. Reporting Limit:** The certified reporting limit was calculated to be 4.08  $\mu$ g/kg.
- D. Interferences:** No interferences were found.
- E. Analysis Rate:** In an 8-hour day, approximately 50 samples can be processed and analyzed.

**F. Safety Information:** White phosphorus is highly toxic and may ignite at 30°C if exposed to air. Procedures requiring the use of the solid material, such as the preparation of a stock solution, should be performed only in an inert atmosphere such as a nitrogen-purged glove bag. Skin contact with potentially contaminated soil should be avoided. Isooctane is a flammable organic solvent. Normal laboratory safety precautions should be followed.

### **III. Apparatus and Chemicals**

#### **A. Glassware/Hardware**

1. Glass vials, 40-mL, equipped with Teflon-lined caps
2. Pipettes - 5 and 10-mL, volumetric, glass
3. Glove box or inflatable glove bag
4. Injection syringe - Hamilton, gas tight, 10- $\mu$ L
5. Glass vacuum apparatus (to degas water)
6. Tweezers
7. Razor blades

#### **B. Instrumentation**

1. Gas chromatograph equipped with a nitrogen-phosphorus detector (NPD), SRI 8610 or equivalent.
2. DB-1 Megabore column, 15 m, 3.0 $\mu$ m film thickness, J and W #125-1014 or equivalent.
3. Digital integrator - HP3396A or equivalent
4. Vortex mixer
5. Platform shaker
6. Analytical balance ( $\pm 0.1$  mg)

### **C. Analyte**

White phosphorus (P<sub>4</sub>)

CAS # [7723-14-0]

Density: 1.8 g/cm<sup>3</sup>

Water solubility (15°C): 2.4 mg/L

Melting point: 44°C

Vapor pressure (20°C): 0.026 mm Hg

Octanol/water partition coefficient: 1200

### **D. Reagents**

White phosphorus (99+%), Aldrich Chemical Co. # 30,255-4

Isooctane (2,2,4-trimethylpentane), A.C.S. spectrophotometric grade

Water - Reagent grade

Nitrogen - pre-purified (for glove bag)

Nitrogen - zero grade (for GC carrier gas)

Hydrogen - zero grade (for NPD flame)

## **IV. Calibration**

### **A. Initial Calibration**

**1. Preparation of Standards.** The stock solution is prepared in a nitrogen-purged glove bag. The white phosphorus available from Aldrich Chemical Co. is a stick that is stored under water, and it generally has a white oxidized coat. A razor blade is used to slice a small piece (approximately 100 mg) off the stick of white phosphorus. Then the razor blade is used to remove the white oxidized coating. The piece of white phosphorus should be lustrous in appearance on all surfaces. The piece is dried under a gentle stream of nitrogen; since white phosphorus is hydrophobic, it sheds water immediately. Using a tweezers, the piece is placed in a preweighed 250-mL volumetric flask con-

taining a small amount of isooctane. The mass of white phosphorus is determined by difference. The flask is brought to volume with isooctane, and shaken until the white phosphorus dissolves. (To protect the stock solution from light, the flask is wrapped in aluminum foil). This stock solution has a concentration of approximately 400 mg/L.

A working stock solution is prepared by pipetting 1.00 mL of the stock solution into a 100-mL volumetric flask, and bringing the flask to volume with isooctane. The working stock solution has a concentration of approximately 4.00 mg/L.

To prepare calibration standards, 2.00 mL of the working stock solution is placed in a 100-mL volumetric flask and the flask brought to volume with isooctane. The resulting solution will have a concentration of 80.0  $\mu\text{g/L}$  and serves as the 10XTRL standard. Solutions corresponding to 0.5X, 1.0X and 2XTRL are prepared in 100-mL volumetric flasks with 5.00, 10.0 and 20.0 mL of the 10XTRL standard. The solutions have concentrations of approximately 4.00, 8.00, and 16.0  $\mu\text{g/L}$ . A solution corresponding to 5XTRL is prepared with 25.0 mL of the 10XTRL in a 50-mL volumetric flask and has a concentration of approximately 40.0  $\mu\text{g/L}$ . Assuming a 10.0 g soil subsample is extracted with 10 mL of solvent, the concentration range for the calibration standards is equivalent to 4.0-80  $\mu\text{g/kg}$ . Stock solutions and calibration standards are stored at 4°C in the dark.

**2. Instrument Calibration.** Duplicate 1.0- $\mu\text{L}$  aliquots of each standard are injected into the GC in random order. Peak heights or areas are obtained on the digital integrator.

**3. Analysis of Calibration Data.** The acceptability of a linear model with zero intercept is assessed using the protocol specified in USATHAMA QA program (January, 1990). Based on the precertification calibration curve, a linear model

with zero intercept is appropriate. Therefore, the slope of the best-fit regression line is equivalent to a response factor that can be compared with values obtained from replicate analyses of a single standard each day.

**B. Daily Calibration.** The 80.0  $\mu\text{g/L}$  (10XTRL) standard is used for daily calibration. This standard is analyzed in triplicate at the beginning of the analysis, singly after each ten samples and singly after the last sample of the day. A response factor is obtained from the mean peak height obtained over the course of the day and compared with the response factor obtained for initial calibration. These values must agree within  $\pm 25\%$  for the first seven days following the initial calibration and on subsequent days must be within  $\pm 2$  standard deviations or a new initial calibration must be obtained. The response is expected to decline with operating time of the thermionic source in the nitrogen-phosphorus detector. The rate of decline depends on operating conditions.

## V. Certification Testing

**A. Preparation of Spiking Solutions.** A stock white phosphorus spiking solution (400 mg/L) and a working stock solution (4.00 mg/L) are prepared in an identical manner to that described for the stock calibration standard and working stock solution.

The 10XTRL spiking solution is prepared by pipetting 20.0 mL of the 4.00 mg/L working stock solution into a 100-mL volumetric flask and bringing the flask to volume with isooctane. The resulting solution will have a concentration of 800  $\mu\text{g/L}$  and serves as the 10XTRL spiking solution. Spiking solutions corresponding to 0.5X, 1.0X and 2XTRL are prepared in 100-mL volumetric flasks with 5.00, 10.0 and 20.0 mL of the 10XTRL spiking solution. The solutions have concentrations of approximately 40.0, 80.0, and 160  $\mu\text{g/L}$ . A solu-

tion corresponding to 5XTRL is prepared with 25.0 mL of the 10XTRL in a 50-mL volumetric flask and has a concentration of approximately 400 µg/L.

**B. Preparation of Control Spikes.** Spiked soil samples are prepared by placing 10.0-g subsamples of prewetted USATHAMA Standard Soil in individual 40-mL glass vials. Each sample is spiked with 1.00 mL of one of the spiking standards and extracted as described below for real samples (except that 9.00 mL of isooctane are used for extraction). Samples are extracted immediately after spiking.

**C. Analysis of Soil Spikes.** Soil spikes are analyzed as described below for real samples.

## **VI. Sample Handling and Storage**

All soil samples are stored in tightly sealed glass jars at 4°C in the dark until extracted. Contact with atmospheric oxygen should be as brief as possible since the white phosphorus will oxidize forming phosphoric acid. Sample handling is best performed in a nitrogen-purged glove bag inside a fume hood. Samples containing high concentrations of white phosphorus can be immediately identified by a garlic-like odor and the formation of a cloud of vapor if the sample is exposed to the atmosphere.

## **VII. Procedure**

**A. Soil Extraction.** A 10-g soil subsample is placed into a 40-mL vial containing 10-mL of isooctane. A 5-mL aliquot of degassed water is added; this added water prevents the soil from forming a pellet during the shaking process. The samples are vortex-mixed for 1 minute then placed horizontally on a platform shaker for 12 hours or overnight at 2500 rpm. Samples are allowed to

stand vertically for 15 minutes to allow phase separation, then the isooctane layer is analyzed.

**B. Determination.** A 1.0- $\mu$ L aliquot is injected on-column into the gas chromatograph equipped with a nitrogen-phosphorus detector. The DB-1 Megabore column is maintained at 80°C. The carrier gas is Nitrogen set at 30 mL/min. Under these conditions, white phosphorus elutes at 1.2 min.

### VIII. Calculations

**A. Response Factor.** Since a linear calibration curve with zero intercept is to be expected, calculation of results on a daily basis is obtained using a response factor. The mean response (R) for the white phosphorus standard is obtained in peak height units. The response factor is obtained by dividing the mean response by the known solution concentration (C) in units of  $\mu$ g/L.

$$RF = R/C$$

**B. Analyte concentrations.** Solution concentrations ( $\mu$ g/L) in the extracts ( $C_a$ ) are obtained by dividing the response obtained for each sample ( $R_a$ ) by the response factor

$$C_a = R_a/RF$$

Concentration in soil ( $X_a$ ) on a  $\mu$ g/g or  $\mu$ g/kg basis is obtained by multiplying extract concentrations by the volume of extraction solvent (0.01 L), and dividing by the actual mass of wet soil.

### IX. Daily Quality Control

**A. Control Spikes.** Spiked soil samples are prepared as described for Class 1 methods in the USATHAMA QA Manual (January 1990). For each analytical lot, a method blank, a single spike at two times the certified reporting limit and duplicate spikes at ten times the certified reporting limit are analyzed.



Control spikes are prepared using the appropriate spiking solution in a manner identical to that described in section V.

**B. Control Charts.** The control charts required are described for Class 1 methods in USATHAMA QA Manual (January 1990). Standard Shewhart X and R chart for the duplicate high spikes and moving average X and R charts for the single low spike are required. Details on the charting procedures are specified in USATHAMA QA Manual (January 1990).

#### REFERENCES

1. Hubaux A. and G. Vos (1970) Decision and detection limits for linear calibration curves. Analytical Chemistry, 42:840-855.
2. USATHAMA (1990) U.S. Army Toxic and Hazardous Materials Agency Installation Restoration Quality Assurance Program. Aberdeen Proving Ground, Maryland 21010.

**APPENDIX C. SEDIMENT SAMPLES COLLECTED  
AND ANALYZED DURING 1991**

**Appendix C-1. List of All Samples Collected by Waterfowl Feeding Area of  
Eagle River Flats**

AREA A 91

Area A Sediment Samples - 1991														
UTM Coordinate System		East (m)	Elev. (ft)	Site Description	Date Collected	Sample Mass (g)	Mass WP (µg)	Conc (µg/g)	Salinity (ppt)	Redox (mV)	Water Depth (cm)	Vegetation	pH	T (°C)
Sample #	North (m)													
SPRING														
257	6,800,897.8	353,835.9	13.51	N-1	5/23/91	31.52	not detected		15.2	-233		BR pond		
258	6,800,922.7	353,835.5	13.92	N +50	5/23/91	45.67	not detected				5	BR		
	6,801,022.6	353,835.2	14.30	N+150								Sedge lawn		
259	6,801,022.7	353,821.2	13.57	N +150/25W	5/23/91	38.84	not detected				5	shallow pond		
260	6,801,064.7	353,785.5	14.21	old A-8	5/23/91	35.87	not detected				0			
261	6,800,842.3	353,835.9	13.83	S-1	5/23/91	22.44	not detected		13.5		5	C50/BR50		
262	6,800,817.2	353,836.6	13.28	S +50	5/23/91	30.53	not detected				15	BR75		
263	6,800,792.4	353,837.4	12.61	S-2	5/23/91	32.43	not detected				26	OW/BR		
264	6,800,768.2	353,838.3	13.00	S +100	5/23/91	33.47	0.2067	0.00617			26	OW		
265	6,800,744.0	353,839.3	12.84	S-3	5/23/91	28.76	not detected			-341	20	BR50(dead)		
266	6,800,717.9	353,839.4	13.20	S +150	5/23/91	36.09	not detected		7.9	-270	15	BR40/C1		
267	6,800,692.9	353,840.0	13.33	S-4	5/23/91	22.01	0.0126	0.00057			10	C25/BR25		
268	6,800,870.5	353,807.4	14.22	W-1	5/23/91	29.44	not detected				5	BR25/C1		
269	6,800,871.1	353,782.6	13.59	W +50	5/23/91	41.46	not detected				13	BR50		
270	6,800,871.6	353,757.7	12.30	W-2	5/23/91	30.76	not detected		10.3	-263	36	OW		
271	6,800,872.1	353,732.8	12.29	W +100	5/23/91	32.48	not detected				34	OW		
272	6,800,872.7	353,708.1	13.27	W-3	5/23/91	30.01	not detected				17	BR50		
273	6,800,873.4	353,683.0	12.67	W +150	5/23/91	31.44	not detected			-312	30	OW/BRRedge		
274	6,800,873.7	353,673.2		W +162	5/23/91	31.01	not detected							
275	6,800,873.7	353,658.3	12.87	W-4	5/23/91	31.96	not detected				24	pool near BR		
276	6,800,874.4	353,632.8	12.84	W +200	5/23/91	25.80	not detected		9.6	-358	30			
277	6,800,874.6	353,607.8	12.82	W-5	5/23/91	23.00	not detected			-301		pond BR border		
322	6,800,851.8	353,814.6	12.42	SW-1	5/28/91	31.44	0.961	0.0306	23	-448	23	Crater-BR/C		
323	6,800,834.9	353,796.2	13.26	SW 50m	5/28/91	47.39	0.0124	0.00026			12	BR50		
324	6,800,818.1	353,777.7	13.12	SW-2	5/28/91	52.18	not detected				15	BR75		
325	6,800,801.2	353,759.3	13.52	SW 100m	5/28/91	59.12	not detected				8	BR50(dead)		
326	6,800,784.6	353,740.9	12.81	SW 125m	5/28/91	42.12	not detected				20	OW/BR25		
327	6,800,767.3	353,722.2	13.40	SW-3	5/28/91	34.28	not detected				14	BR50/C1		
328	6,800,750.7	353,703.8	13.90	SW-4	5/28/91	42.46	not detected				10	BR/C		
329	6,800,734.1	353,685.1	13.55	SW	5/28/91	33.13	not detected		7	-357	10	C50/BR20		
330	6,800,868.8	353,862.2	13.69	E-1	5/28/91	31.78	not detected				10	BR75		
331	6,800,868.0	353,887.3	13.99	E 50m	5/28/91	30.57	not detected				0	mudflat		
332	6,800,867.3	353,912.1	13.83	E-2	5/28/91	33.31	not detected		41	-342	0	mudflat		
333	6,800,866.6	353,937.2	14.34	E 100m	5/28/91	30.68	1.9029	0.06202			0	mudflat		
334	6,800,865.9	353,662.0	13.80	E	5/28/91	33.15	0.005	0.00015	18.5	-360	3	shal.pond		

AREA A 91

Area A Sediment Samples - 1991														
Sample #	UTM Coordinate System			Elev. (ft)	Site Description	Date Collected	Sample Mass (g)	Mass WP (µg)	Conc (µg/g)	Salinity (ppt)	Redox (mV)	Water Depth (cm)	Vegetation	pH T(°C)
	North (m)	East (m)												
335	6,800,849.0	353,853.4	13.81	SE-1	5/28/91	31.71	not detected				10	C30/BR5		
336	6,800,830.6	353,870.5	13.85	SE (50m)	5/28/91	50.40	1.36	0.0269			3	C10/BR/Tr		
337	6,800,812.6	353,887.5	13.28	SE-2	5/28/91	26.12	1.00	0.0381			10	BR75		
338	6,800,794.2	353,904.5	12.85	SE 100m	5/28/91	22.46	not detected				21	OW pond		
339	6,800,776.1	353,921.7	13.20	SE-3	5/28/91	27.36	not detected				18	OW main pond		
340	6,800,757.7	353,938.2	12.63	SE 150m	5/28/91	30.58	not detected				28	OW		
341	6,800,739.5	353,955.8	12.80	SE-4	5/28/91	30.29	not detected				35	OW		
342	6,800,721.1	353,972.8	12.88	SE 200m	5/28/91	26.65	not detected				25	OW		
Jeep	6,800,698.0	353,923.8	15.58											
343	6,800,702.9	353,989.7	12.84	SE-5	5/28/91	32.72	not detected				25	OW		
344	6,800,684.8	354,006.6	12.91	SE 250m	5/28/91	34.07	not detected				23	OW		
345	6,800,666.2	354,023.6	13.66	SE-6	5/28/91	29.54	not detected				19	OW		
346	6,800,889.2	353,817.0	13.79	NW-1	5/28/91	33.11	not detected				13	BR/C/pond		
347	6,800,907.1	353,799.6	13.52	NW 50m	5/28/91	35.13	not detected				13	BR		
348	6,800,909.6	353,797.5	13.59	NW 55m	5/28/91	29.52	not detected				crater	blister		
349	6,800,925.1	353,782.4	13.27	NW-2	5/28/91	32.52	not detected				10	BR		
350	6,800,943.1	353,765.0	13.49	NW 100m	5/28/91	30.22	not detected				13	BR75		
351	6,800,961.1	353,747.8	13.69	NW-3	5/28/91	25.85	not detected				8	OW/BR		
FALL														
391	6800845.5	353881.5	13.93	ESE 50m	8/20/91	36.2	0.124	0.00341	*	1.5	-111	3	Tri25/OW-50	8.5 17.0
392	6800834.7	353903.7	13.82	ESE 75m	8/20/91	40.4	0.0515	0.00127	*	5.1	-120	7	Tri/BR dead	7.5 16.0
393	6800823.8	353926.2	13.90	ESE 100m	8/20/91	39.0	not detected			6.1	-200	3	Tri 10	8 17.5
394	6800813.0	353948.6	13.60	ESE 125m	8/20/91	28.7	not detected			4.5	-193	18	BR /C-5	7 15.1
395	6800802.0	353970.9	13.71	ESE 150m	8/20/91	31.5	not detected			3.9	-160	13	BR40(45 cm)	7 15.5
396	6800790.6	353993.1	13.45	ESE 175m	8/20/91	34.9	not detected			5.9	-165	15	BR/Tr/WG/C	7 16.5
397	6800779.7	354015.7	13.79	ESE 200m	8/20/91	27.8	not detected			3.9	-240	12	BR dead	7 15.5
398	6800773.8	354036.3	13.59	E from Bd.Walk 0m	8/20/91	39.4	not detected			4.8	-208	17	BR15(35cm0	7 16.0
399	6800784.9	354058.8	13.48	E from Bd.Walk 25m	8/20/91	33.8	not detected			5.0	-243	17	BR20(30cm)	7 16.0
400	6800796.2	354080.9	13.62	E from Bd.Walk 50m	8/20/91	36.9	not detected			6.5	-212	16	BR20(dead)	7 16.1
401	6800807.3	354103.1	13.71	E from Bd.Walk 75m	8/20/91	40.0	not detected			6.9	-253	12	BR10(dead)C1	7 16.1
402	6800821.4	354131.6	14.00	E from Bd.Walk 100m	8/20/91	35.0	not detected			6.6	-281	11	BR5-pond edg.	7 17.5
403	6800934.9	353990.1	14.22	NE Shal. Pond 0m	8/20/91	34.9	not detected			7.0	-226	7	OW-Tri	7.5 19.5
404	6800958.4	353981.9	14.28	NE Shal. Pond 25m	8/20/91	35.0	not detected			8.5	-318	3	OW	8 21.0
405	6800982.0	353973.8	14.31	NE Shal. Pond 50m	8/20/91	13.3	not detected			8.5	-274	3	OW	8 22.0
406	6801005.7	353965.6	14.14	NE Shal. Pond 75m	8/20/91	37.5	not detected			7.5	-352	7	OW	8 20.5
407	6801029.3	353957.2	14.13	NE Shal. Pond 100m	8/20/91	31.6	not detected			6.9	too dry	10	OW	8 21.0

AREA A 91

Area A Sediment Samples - 1991														
Sample #	UTM Coordinate System		Elev. (ft)	Site Description	Date Collected	Sample Mass (g)	Mass WP (µg)	Conc (µg/g)	Salinity (ppt)	Redox (mV)	Water Depth (cm)	Vegetation	pH	T (°C)
	North (m)	East (m)												
408	6801052.4	353949.3	14.32	NE Shal. Pond 125m	8/20/91	43.1	not detected		6.1	too dry	8	Tri edge	7.5	20.0
409	6801076.7	353941.1	14.79	NE Shal. Pond 150m	8/20/91	35.4	not detected		8.1	too dry	11	OW	8	20.5
410	6801256.3	353666.5	14.30	Pond NW of 2.5 t truck	8/20/91	16.1	not detected		19.6	-254	13	Puct/OW	8	
411	6801163.2	353716.7	13.94	Pond btw 2.5 t truck/A	8/20/91	12.8	0.0281	0.00220	7.9	-263	3	Puc/Tri edge	8	22.5
412	6801140.8	353727.9	13.67	Pond btw 2.5 t truck/A	8/20/91	37.5	not detected		7.1	too dry	11	OW		20.5
413	6801117.5	353738.4	13.83	Pond btw 2.5 t truck/A	8/20/91	33.3	0.0213	0.00064	6.1	too dry	6	C/OW/edge	8	21.9
414	6801094.6	353748.1	13.88	Pond btw 2.5 t truck/A	8/20/91	31.9	not detected		7.2	too dry	8	BR1(dead)	8	20.5
497	6,800,457	354,310		Offter Pond edg	8/26/91	33.2	not detected		5.0	-294	23	WG/Tall C	8	13.5
498	6,800,443	354,330		Offter Pond	8/26/91	34.9	not detected			-314	25	WG		
499	6,800,423	354,367		Offter Pond	8/26/91	33.5	not detected			-255	27	WG/Tall C		
500	6,800,380	354,403		Offter Pond	8/26/91	33.0	not detected			-240	20	WG/Hip/Tall C		
501	6,800,370	354,427		Offter Pond	8/26/91	31.7	not detected		5.5	-265	15	WG/Tall C	7.5	14.0
502	6,800,457	354,453		Offter Pond	8/26/91	28.8	not detected		6.0	-360	9	Tri/Plan/Ctall		
503	6,801,462	353,183		NW ponds	8/26/91	31.5	not detected		5.5	too dry	17	edge C/Pot/GT		22.0
504	6,801,390	353,190		NW ponds	8/26/91	35.1	not detected			-280	5	mud		
505	6,801,403	353,259		NW ponds	8/26/91	33.5	not detected			-279	5	mud		
506	6,801,362	353,266		NW ponds	8/26/91	33.5	not detected		6.5	too dry	5	feathers		21.5
507	6,801,290	353,293			8/26/91	31.7	not detected			-303	8	Pot/C/Tri		
508	6,801,245	353,300			8/26/91	27.0	not detected			-281	10	Blister		
509	6,801,241	353,366			8/26/91	30.9	not detected		6.5	-384	35	muck		23.0
510	6,801,297	353,321		Small pond edg	8/26/91	35.4	not detected			too dry	12	mud/bl.specks		
511	6,801,428	353,355		Small pond	8/26/91	32.3	not detected		6.5	-291	8	mud		
512	6,801,448	353,376		Shallow pond	8/26/91	48.7	not detected			-315	5	mud		
513	6,801,434	353,434		Old Channel	8/26/91	34.1	not detected		5.5	-360	15	WG/moss		
514	6,801,372	353,428		Old channel	8/26/91	30.6	not detected			-328	15	mud		
515	6,801,297	353,430		Old channel edg	8/26/91	32.6	not detected			too dry	25	BR9dying		

AREA A 91

Area A Sediment Samples - 1991												
UTM Coordinate System												
Sample	North (m)	East (m)	Elev. (ft)	Site Description	Date Collected	Sample Mass (g)	Mass WP (µg)	Conc (µg/g)	Salinity (ppt)	Redox (mV)	Water Depth (cm)	Vegetation
Close	Interval	Samples										pH T (°C)
415	6,800,867.6	353,937.2		1 m N of 333	8/20/91	37.9	not detected			too dry		
416	6,800,866.6	353,938.2		1 m E of 333	8/20/91	37.4	not detected			too dry		
417	6,800,866.6	353,936.2		1 m W of 333	8/20/91	40.7	not detected			too dry		
418	6,800,865.6	353,937.2		1 m of 333	8/20/91	33.2	not detected			too dry		
419	6,800,831.2	353,871.2		E of 336	8/20/91	32.1	1.71	0.0534		-323		BR10/Tri20
420	6,800,831.2	353,869.8		N of 336	8/20/91	25.9	0.0989	0.00382		-289		
421	6,800,829.8	353,869.8		W of 336	8/20/91	38.9	0.0164	0.00042		-252		
422	6,800,829.8	353,871.2		SE of 336	8/20/91	42.2	not detected			too dry		
423	6,800,821.6	353,879.0		Btw 336 and 337 (1/2)	8/20/91	32.6	0.135	0.00413		-261	13	

\*WP detected at a concentration less than certified reporting limit (0.004 µg/g).

AREA B 91

Area B- Sample #	Sediment		Samples		1991 Elevation (ft)	Site Description	Date Collected	Mass (g)	Mass WP (µg)	Conc (µg/g)	Salinity (ppt)	Redox (mV)	Wat Depth (cm)	Vegetation	pH	T (°C)
	North (m)	East (m)														
466						pond Near B1-2	8/23/91	35.4	not detected		1.5	-226	12	BR/WG		15.5
467						pond Near 466?	8/23/91	27.6	not detected		3.5	-303	12	WG/BR	7	14.0
468	6,799,119.4	355,432.1			12.57	small pond	8/23/91	29.1	not detected		3.0	-242	33	Carex border	7	16.0
469	6,799,101.0	355,451.8			13.47	small pond	8/23/91	30.9	not detected			-320	40	WG75		
470	6,799,084.4	355,483.3			11.84	large pond area	8/23/91	31.9	not detected		2.5	-356	42	BR(S,v and p)		14.5
471	6,799,059.8	355,494.7			11.85	pond complex	8/23/91	30.6	not detected		3.0	-370	36	BR/Ct	7	16.5
472	6,799,040.7	355,493.4			11.49	pond complex	8/23/91	27.7	not detected		2.0	-337	30	BR/Hip/C		15.0
473	6,799,035.1	355,521.2			11.31	pond complex	8/23/91	32.0	not detected		2.0	-287	38	BRo		15.5
474	6,799,020.2	355,540.0			11.83	pond complex	8/23/91	30.3	not detected		1.5	-297	33	BRo/WG		14.0
475	6,798,980.0	355,546.7			11.49	pond complex	8/23/91	22.9	not detected			-253	42	BRo(1m)WG		
476	6,799,224.8	355,406.0			13.84	pond complex	8/23/91	34.6	not detected			-297	46	BRo(1m)		
477	6,799,260.4	355,386.5			13.85	shallow pond	8/23/91	31.4	not detected		2.0	-393	10	WG/Hip		
478	6,799,309.2	355,362.5			13.35	new shal pond	8/23/91	17.3	not detected		3.5	-348	15	BR/Hip/C	7.5	15.0
479						larger pond	8/23/91	20.4	not detected		3.5	-356	15	BR/Hip/WG/C	8	15.5
480						small pond	8/23/91	45.7	not detected			-359	10	blister (H2S)		

AREA C

UTM No.	Area C - Sediment Samples - 1991		Date Col	Mass (g)	WP Mass (µg)	WP Conc (µg/g)	Sal (ppt)	Red (mV)	Dep (cm)	Vegetation	pH	T(C)
	North	East										
200	6,801,163	355,132	5/21	38.7	0.140	0.0036			11	OW		
201	6,801,163.4	355,108.4	5/21	21.4	not detected		8.0	-186	10	1% Tri (crater)		
202	6,801,163.3	355,085.2	5/21	36.8	not detected				5	OW		
203	6,801,163.2	355,060.7	5/21	31.6	not detected				9	OW		
204	6,801,163.2	355,035.1	5/21	32.3	not detected				6	OW		
205	6,801,163.0	354,985.2	5/21	27.2	0.603	0.0222			6	20% Tri		
206	6,801,163.0	354,935.1	5/21	31.9	not detected		10.8	-184	3.5	80% Tri		
207	6,801,162.6	354,885.1	5/21	37.3	0.391	0.0105			2	10% Tri		
208	6,801,233.2	354,976.9	5/21	37.2	0.0128	0.0003				OW		
209	6,801,233.2	354,976.9	5/21	33.1	not detected		9.7	-208	10	OW		
210	6,801,233.2	354,976.9	5/21	33.3	0.0357	0.0011		-200		OW		
211	6,801,150.8	355,142.0	5/21	26.8	not detected				10	OW		
212	6,801,127.0	355,140.9	5/21	33.3	not detected				11	OW		
213	6,801,101.3	355,143.2	5/21	24.9	not detected				11	OW		
214	6,801,078.5	355,138.7	5/21	21.8	not detected		9.7	-157	10	90% Tri		
215	6,801,053.3	355,135.3	5/21	28.0	not detected		8.5	-198	10	OW		
216	6,801,176.8	355,170.4	5/21	21.7	not detected				18	OW		
217	6,801,175.7	355,195.7	5/21	21.1	not detected				12	40% Tri		
218	6,801,174.3	355,220.4	5/21	26.1	1.72	0.0659			18	Hip, Carex, BR		
219	6,801,172.8	355,245.6	5/21	29.5	not detected		7.4	-223	38	BR		
220	6,801,171.5	355,269.5	5/21	33.4	0.0266	0.0008			22	BR		
221	6,801,170.1	355,295.9	5/21	29.0	0.160	0.0055		-279	50	OW		
222			5/21	31.9	22.5	0.705			45	OW		
223	6,801,206.0	355,145.2	5/22	29.2	0.404	0.0139			15	OW/ Tri		
224	6,801,231.1	355,146.5	5/22	29.0	0.0257	0.0009			13	BR		
225	6,801,255.9	355,147.3	5/22	17.5	not detected		8.7	-155	23	OW		
226	6,801,281.0	355,148.8	5/22	32.0	not detected				17	OW		
227	6,801,305.6	355,150.0	5/22	30.5	not detected				15	OW		
228	6,801,330.7	355,150.8	5/22	28.6	0.0286	0.0010			10	OW		
229	6,801,355.7	355,151.8	5/22	24.3	0.0415	0.0017			5	70% Tri		
230	6,801,380.7	355,152.9	5/22	31.1	0.0822	0.0026			23	Edge Tri/BR		
231	6,801,408.1	355,154.1	5/22	22.9	0.0052	0.0002		-292	20	BR		
232			5/22	33.7	39.0	1.16			9	BR		
233	6,801,198.6	355,123.6	5/22	26.5	not detected				5	OW		
234	6,801,216.7	355,106.0	5/22	38.1	0.0428	0.0011		-217	13	OW		
235	6,801,217.5	355,087.8	5/22	18.7	118.4	6.32			11	OW		



AREA C

Area C - Sediment Samples - 1991														
UTM No.	North	East	Elev	Description	Date Col	Mass (g)	WP Mass (µg)	WP Conc (µg/g)	Sal (ppt)	Red (mV)	Dep (cm)	Vegetation	pH	T(C)
236	6,801,251.8	355,070.5	15.3	NW +100	5/22	21.4	not detected	0.0011			13	OW		
237	6,801,269.4	355,052.7	15.3	NW-3	5/22	22.0	not detected				13	OW		
238	6,801,286.9	355,034.9	15.4	NW +150	5/22	32.1	not detected				15	OW		
239	6,801,304.8	355,617.3	15.2	NW-4	5/22	23.8	0.0120	0.0005		297	14	OW		
240	6,801,322.4	354,999.4	14.3	NW +200	5/22	35.2	117.0	3.33	9.5	-252	45	OW		
241	6,801,339.6	354,981.5	15.1	NW-5	5/22	31.5	0.0640	0.0020			12	ow/Tri patch		
242	6,801,357.4	354,963.7	15.3	NW +250	5/22	34.3	0.128	0.0037			10	OW		
243	6,801,374.8	354,946.1	15.5	NW-6	5/22	58.5	0.0158	0.0003			5	10%Tri,5%Hip		
244	6,801,385.8	354,938.2	15.5	across a Tri upland	5/22	33.9	not detected		13.2	-207	5	OW		
245	6,801,407.4	354,911.6	15.3	NW-7	5/22	34.6	not detected		15.8	-266	7	OW		
278	old 53			blister near53	5/24	22.8	3.39	0.149				blister		
279	6,801,197.8	355,164.9	15.6	NE-1	5/24	37.7	not detected		8.4	-232				
280	6,801,214.3	355,183.1	15.1	NE +50	5/24	30.7	33.6	1.09				ow(1mto Hip)		
281	6,801,231.3	355,701.5	15.4	NE-2	5/24	48.2	not detected				15	ow (2mto BR)		
282	6,801,248.0	355,220.1	15.2	NE (100m)	5/24	30.2	not detected				15	ow(1m to BR)		
283	6,801,264.8	355,238.5	14.7	NE-3	5/24	31.3	not detected		9.5	-285	37	BR		
284	6,801,281.7	355,256.9		NE +150	5/24	25.2	not detected				30	.5 m to BR		
285	6,801,298.6	355,275.3		NE-4	5/24	27.7	0.267	0.0096			24	75%BR		
286	6,801,315.5	355,293.8		Clunie channel outlet	5/24	33.5	not detected				27	ow		
287	6,801,332.4	355,312.2		NE-5	5/24	49.2	not detected		7.0	-291	27	ow (blisters)		
288	6,801,325.0	355,318.9		carcass on bot.(w of ne-4	5/24	52.6	0.0800	0.0015			33	blister		
289	6,801,159.0	355,163.8	15.3	SE-1	5/24	31.4	0.0107	0.0003	8.3	-248	11	BRclump		
290	6,801,141.9	355,182.1	15.9	SE +50	5/24	37.0	not detected				5	90%sedg		
291	6,801,124.9	355,200.5	15.5	SE-2	5/24	45.1	not detected				0	90%talised/BR		
292	6,801,108.3	355,219.1	15.4	SE +100	5/24	45.2	not detected				0	tail sedg		
293	6,801,091.5	355,237.4	15.6	SE-3	5/24	49.3	not detected		10.0	-242	5	80%tsedg/tri		
294	6,801,074.8	355,256.1	15.7	SE +150	5/24	30.0	not detected				5	50%tsed/tri		
295	6,801,058.1	355,274.7	15.2	SE-4	5/24	43.5	not detected				10	br/tri patch		
296	6,801,041.4	355,293.3	15.6	SE +200	5/24	39.9	not detected		10.8	-230	10	OW		
297	6,801,026.6	355,309.7	15.5	SE-5	5/24	36.3	not detected		11.5	-248	10	OW		
298	6,801,160.5	355,121.4	14.5	SW-1	5/24	44.1	not detected				28	ow in crater		
299	6,801,145.0	355,101.8	15.6	SW +50	5/24	48.1	0.0267	0.0006	9.6		5	edge mudflat		
300	6,801,129.4	355,082.6	15.6	SW -275	5/24	35.1	not detected				0	mud/10%Tri		
301	6,801,113.4	355,063.3	16.0	SW +100	5/24	30.7	not detected		19.9	-300	0	mud/10%Tri		
302	6,801,097.5	355,044.0	15.8	SW-3	5/24	26.2	0.0053	0.0002			0	mud		
303	6,801,082.0	355,024.5	16.0	SW +150	5/24	22.9	not detected		too dry		0	mud/5%Tri		

AREA C

No.	Area C- UTM Coordinates (m)		Sediment Samples - 1991		Date	Mass (g)	WP Mass (µg)	WP Conc (µg/g)	Sal (ppt)	Red (mV)	Dep (cm)	Vegetation	pH	T(C)
	North	East	Elev	Description										
304	6,801,066.4	355,005.0	16.1	SW-4	5/24	32.8	0.0800	0.0024	too dry		0	mud/25%Tri		
305	6,801,050.4	354,985.6	16.3	SW +200	5/24	22.9	not detected		too dry		0	mudflat		
379	6,801,348.3	355,069.6	15.0	NNW +175m	5/30	28.8	0.0059	0.0002			14	OW		
380	6,801,371.6	355,059.1	15.0	NNW +200m	5/30	27.1	0.0704	0.0026		-195	7	OW		
381	6,801,393.9	355,050.0	14.9	NNW +225m	5/30	34.2	0.564	0.0165			9	OW		
382	6,801,416.8	355,040.0	15.1	NNW +250m	5/30	30.9	0.329	0.0106			6	on istmus		
383	6,801,440.0	355,030.8	15.6	NNW +275m	5/30	29.7	not detected			-162	3	Sedge		
384	6,801,462.6	355,021.2		NNW + 300 next pond	5/30	34.6	not detected				9	ow		
385	6,801,485.1	355,011.4		NNW +325m	5/30	31.0	not detected				10	ow		
386	6,801,507.6	355,001.7		NNW +350m	5/30	30.7	not detected				10	ow		
387	6,801,530.1	354,992.0		NNW +375m	5/30	34.9	not detected				5	OW		
388	6,801,552.5	354,982.3		NNW +400m	5/30	33.7	not detected			-208	3	OW		
389	6,801,575.0	354,972.5		NNW +425m	5/30	29.0	not detected				0-3	ow		
390				E-4	5/30	40.0	not detected							
544	6,801,171.0	355,283.0		E line- between 220 and 221.	8/27	32.4	0.182	0.0056		-222	33	wg/ow		
545	6,801,336.0	355,123.9	14.1	Between 228, N and NNW line	8/27	33.9	not detected			-230	25	wg		
546	6,801,347.2	355,099.0		Between N and NNW line	8/27	33.4	not detected			too dry	12	BR		
547	6,801,363.0	355,088.8	14.3	Narrow back channel	8/27	33.1	0.0647	0.0020	*	-291	25	BR channel		
548	6,801,366.6	355,041.2	14.7	Open water bwt NNW and NW	8/27	37.5	0.413	0.0110		-234	20	ow		
549	6,801,365.7	355,021.4	14.7	Between NNW and NW	8/27	28.6	0.154	0.0054		-205	20	wg/ow		
550	6,801,361.7	354,999.6	14.4	Between NNW and NW	8/27	24.7	0.0576	0.0023	*	-272	18	ow/wg		
551	6,801,360.1	354,980.4	14.8	Approaching 242	8/27	34.5	0.0411	0.0012	*	too dry	15	wg		
552	6,801,350.3	354,974.2	14.8	NW line between 241 and 242.	8/27	34.7	not detected			too dry	10	wg		
553	6,801,342.1	354,952.5	15.1	W of NW line, hard sod/ mud.	8/27	32.0	not detected			too dry	15	no wg		
554	6,801,330.4	354,935.4	15.1		8/27	34.1	not detected			too dry	10	no wg		
555	6,801,313.8	354,916.3	15.0	Near island	8/27	36.2	not detected			too dry	11	C sod		
556	6,801,358.2	354,925.6	15.1	mortar fin pond	8/27	35.9	not detected			too dry	11			
557	6,801,364.3	354,903.9	15.3	mortar fin pond	8/27	34.2	not detected			too dry	10			
582			C	crater bottom, June exp.	8/28	36.7	not detected			-316	74-80			
583			C	crater rim composite	8/28	26.6	not detected			-278				
595	6,801,183.1	355,314.2	14.1	Clunie Outlet NW of 153	8/29	31.5	not detected		3.0	-425	37	wg		
596	6,801,195.3	355,303.4	14.4	Clunie outlet area	8/29	25.2	not detected		3.5	-271	35			
597	6,801,221.1	355,294.3	14.2	Clunie Outlet	8/29	23.6	not detected		3.5	-234	37	100%wg/1%br		
598	6,801,240.0	355,285.8	14.5	Clunie outlet	8/29	38.8	not detected		3.5	-275	33	ow		
599					8/29	18.6	not detected			-230	37	100%wg		
600	6,801,282.8	355,280.5	14.2	Clunie area	8/29	31.1	not detected			-269	35	2 m to br		
601	6,801,301.4	355,283.0	14.4	Clunie NE-4 and 286	8/29	24.1	not detected			-310	35	edge of br		

AREA C

Area C - Sediment Samples - 1991		UTM Coordinates (m)		Description		Date	Mass (g)	WP Mass (µg)	WP Conc (µg/g)	Sal (ppt)	Red (mV)	Dep (cm)	Vegetation	pH	T(C)
No.	North	East	Elev	Description		Col									
602	6,801,319.0	355,299.9	14.2	Clunie NE of 286		8/29	16.9	not detected			-310	33			
603	6,801,343.4	355,323.8	14.4	Clunie shore near NE-5		8/29	20.0	2.07	0.103	2.0	-333	37	edge of br	7.5	11
604	6,801,360.6	355,307.5	14.5	near pt of beaver chan. to c/d		8/29	31.5	not detected			-336	20			
605	6,801,296.6	355,389.2	16.2	N shore of Clunie Inlet		8/29	22.4	not detected			-308	35	ow		
606	6,801,281.4	355,348.8	16.7	land, near side of Clunie Ck		8/29	26.1	not detected		3.0	-338	40	wg		
607				Clunie Ck		8/29	23.9	not detected			-309	50	wg		12
608	6,801,301.2	355,336.4	13.8	Clunie Ck		8/29	17.9	not detected			-318	47	wg		
609	6,801,316.7	355,322.4	14.1	Clunie Ck		8/29	39.6	0.435	0.011C		-302	37			
610	6,801,313.7	355,301.5	14.1	Pt on S side of mouth of Clunie Ck		8/29	38.4	not detected			-301	37			
611	6,801,293.9	355,268.9	14.0	Bullrush area		8/29	22.2	0.222	0.0100		272	25	BR channel		
612	6,801,295.8	355,255.9	13.8	Bullrush area		8/29	42.1	0.0422	0.0010	*	-306	40	edge BR channel		
613	6,801,298.0	355,239.5	14.1	Bullrush area		8/29	24.3	0.0108	0.0004	*	-353	35	center BR chan		
614	6,801,307.1	355,214.0	14.3	Bullrush area		8/29	29.3	0.0469	0.0016	*	-349	37	BR end of chan		
615	6,801,314.4	355,205.0	14.4	Bullrush area		8/29	29.2	32.7	1.12	3.5	-342	28	BR		12
616	6,801,332.7	355,212.8	13.9	Bullrush area		8/29	30.9	not detected		4.0	-331	30	BR pond/wg		13.5
<b>SEDIMENT CORES</b>															
558	6,801,322.4	354,999.4		core at 240, 0-3 cm		8/27	19.0	0.912	0.0480		core	35			
559	6,801,322.4	354,999.4		core 3-6 cm		8/27	28.4	104	3.66		core	35			
560	6,801,322.4	354,999.4		core, 6-10 cm		8/27	39.0	118	3.02		core	35			
561	6,801,322.4	354,999.4		core, 10-17 cm		8/27	28.0	161	5.76		core	35			
617				Core at 221 (E+150m) (0-7 cm)		8/29	25.6	0.253	0.0099		-359				
618				Core 7-14 cm		8/29	36.0	0.127	0.0035	*					
619				Core 14-24 cm		8/29	35.3	not detected							
620				Core 24-28 cm		8/29	23.9	not detected							
569	6,801,234.5	355,088.6		Core 235, 0-5 cm		8/28	35.3	2101	59.5		core				
570	6,801,234.5	355,088.6		Core 5-13 cm		8/28	21.7	0.738	0.0340		core				
539	6,801,173.9	355,329.9		Core near 53, surface 0-3 cm		8/27	22.9	225	9.83						
540	6,801,173.9	355,329.9		Core, 3-7 cm		8/27	20.7	3705	179						
541	6,801,173.9	355,329.9		Core, 7-11 cm		8/27	12.0	1.55	0.129						
542	6,801,173.9	355,329.9		Core, 11-13 cm		8/27	27.9	5521	198						
569	6,801,234.5	355,088.6		Core 235, 0-5 cm		8/28	35.3	2101	59.5		core				
570	6,801,234.5	355,088.6		Core 5-13 cm		8/28	21.7	0.738	0.034		core				



AREA C

Area C- Sediment Samples - 1991		UTM Coordinates (m)		Description		Date	Mass	WP Mass	WP Conc	Sal	Red	Dep	Vegetation	pH	T(C)
No.	North	East	Elev			Col	(g)	(µg)	(µg/g)	(ppt)	(mV)	(cm)			
	PLANKTON		NET												
wat	NW line				Plankton Tow 20 microns										
wat	NW line		C		Plankton 1st pass	8/28	23.4	0.018	0.0008						
wat			C		Plankton after walking-dist.	8/28	23.5	0.527	0.0224						
wat			C		EOD pond	8/29		not detected							
wat			C		Test crater-undis	8/29		not detected							
wat			C		around crater-disturbed	8/29		0.173							
wat			C		around test crater-disturb			1.09							

\*WP detected at a concentration less than certified reporting limit (0.004 µg/g)

AREA C/D

Area C/D (transition) pond sediment samples												
Sample	UTM Coordinates (m)		Location	Coll. Date	Sample Mass (g)	WP Mass $\mu$ g	WP Conc $\mu$ g/g	Salin. ppt	Redox mv	Depth cm	Vegetat.	Temp pH
	North	East			Mass (g)	$\mu$ g	$\mu$ g/g	ppt	mv	cm		
424	6,801,964.329	355,028.916	End of pond	8/21/91	27.4	not detected		3.4	too dry	55	Scrp.	
425	6,801,970.986	355,043.261	Mid-channel	8/21/91	10.2	not detected		2.8	-295	68	OW-Pondweed	
426	6,801,989.030	355,057.563	Edge of narrow channel	8/21/91	23.1	not detected		2.5	too dry	51	Scrp.	
427	6,802,007.310	355,072.633	Shallow cove	8/21/91	25.7	not detected		3.1	too dry	50	OW	7.5
428	6,802,007.635	355,102.984	Left end of channel	8/21/91	35.5	not detected		2.1	-326	58	OW	7
429	6,802,031.304	355,112.264	2m from shore	8/21/91	31.0	not detected		1.2	too dry	43	Pondweed	
430	6,802,027.154	355,153.171	Small cove	8/21/91	28.7	not detected		0.9	too dry	50	OW	7.5
431	6,802,041.989	355,145.138	Big Pond	8/21/91	29.7	not detected		0.8	-266	47	OW	
432	6,802,055.856	355,130.665	Middle Pond	8/21/91	31.8	not detected		0.9	too dry	43	OW	
433	6,802,082.780	355,129.310	Near shore	8/21/91	28.1	not detected		1.3	too dry	45	OW	
434	6,802,077.289	355,159.565	Near mouth 4m from shore	8/21/91	29.7	not detected		1.0	too dry	46	Tall Carex	
435	6,802,071.636	355,175.773	Near mouth	8/21/91	26.9	not detected		0.7	too dry	48	OW	
436	6,802,082.299	355,202.051	Narrow channel near shore	8/21/91	23.5	not detected		0.4	-303	43	OW	
437	6,802,105.297	355,198.516	Along board walk	8/21/91	29.5	not detected		4.8	-353	45	Tall Carex	
438	6,802,363.644	355,163.682	Pond, taken near carcass	8/21/91	24.4	not detected		3.1	-264	45	OW	21.0
439	6,802,344.906	355,174.391	Pond	8/21/91	37.2	0.049	0.001*	3.0	-302	55	OW	20.0
440	6,802,336.319	355,183.937	Pond	8/21/91	42.9	not detected		0.5	-293	43	WG	21.5
441	6,802,324.175	355,205.825	Pond	8/21/91	27.4	not detected		3.0	-281	40	WG	22.0
442	6,802,301.133	355,210.547	Pond, 2m from shore	8/21/91	46.4	not detected		2.0	-303	46	WG	20.5
443	6,802,325.188	355,225.160	Pond, lots of blisters	8/21/91	26.9	not detected		3.2	-289	37	blisters	21.0
444	6,802,356.129	355,227.424	Pond, 2m from shore	8/21/91	29.2	0.353	0.012	0.5	-287	30	WG	20.5
445	6,802,385.336	355,229.596	Pond, 1m from shore (Black)	8/21/91	23.7	not detected		4.3	-310	50	WG	17.5
446			Pond, 1m from shore	8/21/91	38.2	not detected		4.5	-318	42	WG	21.5

\*WP detected at a concentration less than certified reporting limit (0.004  $\mu$ g/g)

AREA D 91

Area D Surface Sediment Samples - 1991												
Sample #	UTM Coordinate System			Elev(ft)	Site Description	Date Collected	Mass (g)	WP Mass (µg)	Salinity (ppt)	Rec. (mV)	Depth (cm)	Temp. C
	North	East										
306	6,802,726.4	355,295.1		N-1 25m	5/27/91	33.42	not detected	7.4	-461		OW	
307	6,802,750.1	355,302.9		N 50m	5/27/91	24.45	not detected				44 OW/BR	
308	6,802,773.6	355,310.7	15.59	N-2 75m	5/27/91	19.61	not detected	9	-487		30 BR clump	
309	6,802,797.5	355,318.8	15.29	N 100m	5/27/91	22.15	not detected				28 Carex, BR	
310	6,802,806.9	355,322.5		N 112m	5/27/91	23.94	not detected				37 Blister/BR	
311	6,802,821.7	355,326.9	14.86	N-3 125m	5/27/91	20.67	not detected	9.5	-461		32 BR/C	
312	6,802,724.9	355,278.2		NW-1	5/27/91	23.65	not detected		-465		27 OW	
313	6,802,725.9	355,280.7		NW 50m	5/27/91	23.28	not detected				50 OW	
314	6,802,771.9	355,259.2	13.76	NW-2	5/27/91	26.02	not detected	10.5	-353		45 OW/blister	
315	6,802,795.0	355,249.8		NW 100m	5/27/91	31.42	not detected				49 OW	
316	6,802,818.9	355,239.8	14.65	NW-3 (125)	5/27/91	30.59	not detected				36 OW	
317	6,802,818.9	355,239.8		NW 125m	5/27/91	33.61	not detected				Blister	
318	6,802,842.4	355,230.5	13.84	NW 150m	5/27/91	32.14	not detected	7.6	-437		36 OW	
319	6,802,711.1	355,263.7		W-1 25m	5/27/91	30.99	not detected				60 BR5	
320	6,802,719.5	355,240.1		W 50m	5/27/91	27.47	not detected	11	-444		56 OW	
321	6,802,727.8	355,217.3		W-2 75m	5/27/91	30.22	not detected				65 OW/blister	
447	6,802,860.0	355,223.2	14.46	NW line	8/22/91	30.2	not detected	7.0	-285		41 OW/BR clump	15.0 8.5
448	6,802,878.2	355,215.6	14.49	NW line	8/22/91	32.6	not detected	7.0	-305		36 WG/C/BR	15.0
449	6,802,898.1	355,206.0	13.96	NW line	8/22/91	33.4	not detected		-277		38 C/BR	
450	6,802,917.6	355,196.3	13.81	NW line	8/22/91	33.3	not detected		-307		47 BR/C clump	
451	6,802,936.9	355,191.8	13.90	NW line	8/22/91	29.7	not detected	7.0	-318		40 BR/C	15.0 9
452	6,802,960.8	355,183.4	15.09	NW line	8/22/91	31.0	not detected		-300		40 WG	
453	6,802,970.7	355,176.2	15.13	NW line	8/22/91	32.3	not detected	7.0	-321		30 Hip/BR	15.0 8
454	6,802,737.4	355,194.9	13.90	W line	8/22/91	21.8	not detected	6.8	-335		45 OW/BR clumps	17.0 9.5
455	6,802,742.0	355,171.4	13.41	W line	8/22/91	31.4	not detected		-336		47 BR/C clump	
456	6,802,747.8	355,150.8	14.06	W line	8/22/91	28.4	not detected	7.0	-320		48 WG/BR	17.0 9
457	6,802,762.8	355,122.6	14.15	W line	8/22/91	33.7	not detected	7.0	-354		50 BR clumps	17.0 9
458	6,802,775.1	355,092.9	14.63	W line	8/22/91	23.3	not detected	6.8	-340		43 WG/BR/Hip	16.0 9
459	6,802,782.4	355,073.9	14.94	W line	8/22/91	26.6	not detected		-291		46 BR	
460	6,802,779.8	355,063.1	15.07	W line	8/22/91	32.1	not detected	6.5	-348		40 Ctall	15.0 8.5
461	6,802,778.6	355,043.7	14.88	W line	8/22/91	28.6	not detected		-381		21 C/Hip/black muck	
462	6,802,775.7	355,007.1	14.74	W line	8/22/91	34.5	not detected	6.8	-376		20 C/Hip/BR	15.0 8
463	6,802,784.5	354,950.3	15.03	W line	8/22/91	34.7	not detected	7.5	-368		20 Hip/WG/BR	16.0 7.5
464	6,802,789.2	354,922.0	15.18	W line-mudflat	8/22/91	36.8	not detected	7.5	-340		10 OW	19.0 7.5
465	6,802,846.0	354,947.0	14.60	W line	8/22/91	37.1	not detected		-350		12 WG	

AREA D 91

Area D Surface Sediment Samples - 1991												
Sample #	UTM Coordinate System		Elev(ft)	Site Description	Date Collected	Mass (g)	WP Mass (µg)	Salinity (ppt)	Redox (mV)	Depth (cm)	Vegetation	Temp. C
	North	East										
516	6,802,675	354,710		D West-mudflat	8/26/91	36.2	not detected	3.5	-305	3	Tri	19.5
517	6,802,695	354,725		D West	8/26/91	38.5	not detected		-251	5		
518	6,802,710	354,730		D West	8/26/91	33.9	not detected		-280	5	Tri/C	
519	6,802,725	354,735		D West	8/26/91	36.3	not detected		-297	5	C	
520	6,802,760	354,760		D West	8/26/91	37.0	not detected		-274	11	Hip5	
521	6,802,785	354,770		D West	8/26/91	31.5	not detected	7.5	-220	8	WG	20.5
522	6,802,805	354,795		D West	8/26/91	38.4	not detected		-220	7		
523				D West	8/26/91	33.8	not detected		-192	5		



AREA BREAD TRUCK

Bread Truck Pond Sediment Samples - 1991														
Sample #	UTM Coordinates (m)		Elev (ft)	Location	Sample Date	Sample Mass (g)	WP Mass (µg)	WP Conc. (µg/g)	Salinity ppt	Redox (mv)	Wat. Depth (cm)	Vegetation	pH	T
	North	East												
246	6,801,859.6	354,522.2	15.42	N-S line BT+25m	5/22/91	33.39	0.0511	0.0015	*		5	pond edge		
247	6,801,840.2	354,526.0	15.46	BT+50	5/22/91	25.19	0.0501	0.0020	*		5	OW		
248	6,801,819.3	354,530.0	15.40	BT+75	5/22/91	34.86	2.008	57.6		-249	8	OW		
249	6,801,799.5	354,532.8	15.31	BT+100	5/22/91	32.81	0.149	0.0046			20	OW		
250	6,801,781.0	354,536.6	15.70	BT+125	5/22/91	24.36	14.1	0.579		-263	8	OW		
251	6,801,762.6	354,540.4	15.56	BT+150	5/22/91	34.52	8.80	0.255			9	OW		
252	6,801,744.5	354,543.7	15.16	BT+175	5/22/91	33.80	0.0351	0.0010	*		13	OW		
253	6,801,726.0	354,547.5	15.24	BT+200	5/22/91	30.66	8.54	0.279			15	OW		
254	6,801,706.9	354,550.1	15.51	BT+225	5/22/91	35.77	0.0146	0.0004	*	-239		OW		
255	6,801,687.6	354,553.5	15.86	BT+250	5/22/91	25.93	0.268	0.0103				OW		
256	6,801,661.9	354,560.2	15.86	BT+275	5/22/91	31.13	not detected			-283	5	OW		
353	6,801,884.3	354,372.8	17.03	NW-SE line	5/29/91	35.77	not detected			-296	3	Sallow pond		
354	6,804,871.1	354,393.7	16.84	NW+25	5/29/91	36.52	not detected				5	OW		
355	6,801,856.8	354,414.7	16.13	NW+50	5/29/91	35.63	not detected				5	OW		
356	6,801,844.4	354,436.1	16.08	NW+75	5/29/91	33.83	not detected				9	OW		
357	6,801,831.1	354,457.3	15.53	NW+100	5/29/91	31.69	not detected				8	OW		
358	6,801,817.9	354,478.3	15.62	NW+125m	5/29/91	34.75	0.0364	0.0010	*		5	OW		
359	6,801,804.8	354,499.6	16.30	NW + 150	5/29/91	25.92	873	33.7		-329	15	OW		
360	6,801,791.2	354,521.0	16.28	NW+175	5/29/91	33.33	0.536	0.0161			25	OW		
361	6,801,778.2	354,541.7	16.55	NW+200 (center)	5/29/91	26.00	275	10.6			5	OW		
362	6,801,764.7	354,563.0	16.64	NW+225	5/29/91	29.23	1.42	0.0485			10	OW		
363	6,801,751.7	354,584.1	15.09	NW+250	5/29/91	31.17	not detected				24	OW/BR		
364	6,801,737.9	354,605.7	14.91	NW+275	5/29/91	78.26	0.336	0.0043			15	BR		
481	6,801,737.5	354,376.0		E-W line	8/23/91	8.3	not detected					mudflat		17.0
482	6,801,745.0	354,400.6	15.93	E-W +25	8/23/91	30.4	not detected					mudflat		20.5
483	6,801,752.8	354,424.4	15.90	E-W +50	8/23/91	37.6	not detected				5	mudpond		20.0
484	6,801,760.1	354,447.7	15.86	E-W +75	8/23/91	34.5	2.00	0.0580			8	mudpond		19.5
485	6,801,768.8	354,470.9	16.10	E-W +100	8/23/91	39.6	0.0202	0.0005	*		5	OW		
486	6,801,774.3	354,495.1	16.22	E-W +125	8/23/91	36.6	0.302	0.0083			8	OW		
487	6,801,778.5	354,520.1	15.42	E-W +150	8/23/91	5.8	0.118	0.0203				OW		
488	6,801,782.6	354,543.6	15.64	E-W +175 (center)	8/23/91	34.4	1.82	0.0529			7	black specks		
489	6,801,782.7	354,543.7		E-W +200	8/23/91	38.9	0.0105	0.0003	*			bilister		20.0
490	6,801,788.4	354,568.2	15.64	E-W +225	8/23/91	26.4	0.200	0.0076			15	Hip/WG		
491	6,801,791.8	354,589.1	15.69	E-W +250	8/23/91	33.7	0.0094	0.0003	*		13	Hip		

AREA BREAD TRUCK

Bread Truck Pond Sediment Samples - 1991													
Sample #	UTM North	UTM East	Elev (ft)	Location	Sample Date	Sample Mass (g)	WP Mass (µg)	WP Conc. (µg/g)	Salinity ppt	Redox (mv)	Wat. Depth (cm)	Vegetation	pH
492	6,801,799.1	654,607.2	14.98	E-W +275	8/23/91	31.5	not detected			t.d.	35	WG/scum	T
493	6,801,783.6	354,539.7	15.43	Pond center (250-488-361)	8/23/91	29.8	2,0233	0.0679		-327	10	WG/black speck	
494	6,801,780.5	354,539.7		Bet 250 and 361	8/23/91	35.7	140	3.92		-285	10	OW	
495	6,801,777.2	354,538.5	14.90	Crater 3m from 493	8/23/91	30.6	0.0402	0.0013	*	-400	33	OW	
496	6,801,775.3	354,548.8		Between 361 and 362	8/23/91	28.7	0.746	0.0260		-295	10	OW	
524	6,801,821.3	354,530.0		2 m N of 248	8/26/91	34.1	0.329	0.0097		-236		OW	
525	6,801,819.3	354,528.0		2 m W of 248	8/26/91	37.3	22.7	0.608		t.d.		OW	
526	6,801,817.3	354,530.0		2 m S of 248	8/26/91	33.8	259	7.67		t.d.		OW	
527	6,801,819.3	354,532.0		2 m E of 248	8/26/91	32.5	0.770	0.0237		t.d.		OW	
531	6,801,818	354,493		Shallow Mudflat pond North	8/26/91	37.4	not detected		8.5	-197	5	OW	8.0
532	6,801,936	354,461		North Mudflat	8/26/91	38.0	5.64	0.148		-205	4	OW	
533	6,801,938	354,432		North Mudflat	8/26/91	37.2	not detected			-180	3	OW	
534	6,801,936	354,400		Shallowly flooded mudflat	8/26/91	37.8	not detected			t.d.	0		
<b>CORES</b>													
528	6,801,819.3	354,530.0		Core at 248, 0 - 3 cm	8/26/91	23.9	185	7.72			9		
529	6,801,819.3	354,530.0		Core at 248, 3 - 6 cm	8/26/91	30.3	0.0468	0.0015	*		9		
530	6,801,819.3	354,530.0		Core at 248, 6 - 10 cm	8/26/91	52.9	not detected				9		
535	6,801,819.3	354,530.0		Core at 248, 0 - 3 cm	8/26/91	44.3	0.191	0.0043					
536	6,801,819.3	354,530.0		Core at 248, 3 - 6 cm	8/26/91	45.8	0.0120	0.0003	*				
537	6,801,819.3	354,530.0		Core at 248, 6 - 9 cm	8/26/91	27.6	0.0384	0.0014	*				
<b>Pond Beyond</b>													
pick-up			16.75										
365	6,802,192.0	354,416.5	15.82	PB-1	5/29/91	37.61	not detected						
366	6,803,197.0	354,444.5	14.52	PB-2 (50m)	5/29/91	36.20	not detected		34.9	-256			
367	6,802,198.1	354,466.2	15.96	PB-3 (75m)	5/29/91	28.35	not detected						
368	6,802,201.3	354,491.1	15.52	PB-4 (100m)	5/29/91	35.11	0.764	0.0216		-306			
369	6,802,204.3	354,512.2	16.12	PB-5	5/29/91	35.08	not detected			-312			
370	6,802,209.0	354,559.8	16.59	PB 2nd pond	5/29/91	35.44	not detected		18.8	-302			
371	6,802,210.8	354,577.9	15.85	PB new pond	5/29/91	35.90	not detected						

\*WP detected at a concentration less than certified reporting limit (µg/g)

**Appendix C-2. Samples testing positive for white phosphorus and sorted by  
concentration in each Feeding Pond Area of Eagle River Flats**

AREA A SORTED

Area A Surface Sediment Samples Sorted by Concentration - 1991														
UTM Coordinate System				Elev. (ft)	Site Description	Date Collected	Sample Mass (g)	Mass WP (µg)	Conc (µg/g)	Salinity (ppt)	Redox (mV)	Water Depth (cm)	Vegetation	pH T(°C)
Sample #	North (m)	East (m)												
333	6,800,866.6	353,937.2	14.34	E 100m	5/28/91	30.68	1,9029	0.06202			0	mudflat		
337	6,800,812.6	353,887.5	13.29	SE-2	5/28/91	26.12	1.00	0.0381			10	BR75		
322	6,800,851.8	353,814.6	12.42	SW-1	5/28/91	31.44	0.961	0.0306	23	-448	23	Crater-BR/C		
336	6,800,830.6	353,870.5	13.85	SE (50m)	5/28/91	50.40	1.36	0.0269			3	C10/BR/Tri		
264	6,800,768.2	353,838.3	13.00	S +100	5/23/91	33.47	0.2067	0.00617			26	OW		
391	6800845.5	353881.5	13.93	ESE 50m	8/20/91	36.2	0.124	0.00341	*	-111	3	Tri25/OW-50	8.5 17.0	
411	6801163.2	353716.7	13.94	Pond b/w 2.5 t truck/A	8/20/91	12.8	0.0281	0.00220		-263	3	Puc/Tri edge	8 22.5	
392	6800834.7	353903.7	13.82	ESE 75m	8/20/91	40.4	0.0515	0.00127	*	-120	7	Tri/BR dead	7.5 16.0	
413	6801117.5	353738.4	13.83	Pond b/w 2.5 t truck/A	8/20/91	33.3	0.0213	0.00064	*	too dry	6	C/OW/edge	8 21.9	
267	6,800,692.9	353,840.0	13.33	S-4	5/23/91	22.01	0.0126	0.00057	*		10	C25/BR25		
323	6,800,834.9	353,796.2	13.26	SW 50m	5/28/91	47.39	0.0124	0.00026	*		12	BR50		
334	6,800,865.9	353,662.0	13.80	E	5/28/91	33.15	0.005	0.00015	*	-360	3	shal.pond		

AREA C P4 Sort

No.	UTM Coordinates (m)		Elev	Description	Date	Mass (g)	WP Mass (µg)	WP Conc (µg/g)	Sal (ppt)	Red (mV)	Dep (cm)	Vegetation	pH	T (C)
	North	East												
236	6,801,217.5	355,087.8	15.3	NW-2	5/22	18.7	118	6.32			11	OW		
240	6,801,322.4	354,999.4	14.3	NW +200	5/22	35.2	117	3.33	9.5	-252	45	OW		
238				N-off-208	5/22	33.7	39.0	1.16			9	BR		
290	6,801,214.3	355,183.1	15.1	NE +50	5/24	30.7	33.6	1.09				ow(1mto Hip)		
219	6,801,314.4	355,205.0	14.4	Bullrush area	8/29	29.2	32.7	1.12	3.5	-342	28	BR		12
222				New 53	5/21	31.9	22.5	0.705			45	OW		
278	old 53			blister near53	5/24	22.8	3.39	0.149				blister		
202	6,801,343.4	355,323.8	14.4	Clunie shore near NE-5	8/29	20.0	2.07	0.103	2.0	-333	37	Hlp.Carex .BR	7.5	11
218	6,801,174.3	355,220.4	15.5	E-2	5/21	26.1	1.72	0.0659			18	Hlp.Carex .BR		
205	6,801,163.0	354,985.2	15.8	W +150m	5/21	27.2	0.603	0.0222			6	20%Tri		
261	6,801,393.9	355,050.0	14.9	NNW +225m	5/30	34.2	0.564	0.0165			9	OW		
248	6,801,316.7	355,322.4	14.1	Clunie Ck	8/29	39.6	0.435	0.0110		-302	37	ow		
244	6,801,366.6	355,041.2	14.7	Open water bwt NNNW and NW	8/27	37.5	0.413	0.0110		-234	20	ow		
203	6,801,206.0	355,145.2	15.6	near 153	5/22	29.2	0.404	0.0139			15	OW/ Tri		
207	6,801,162.6	354,985.1	15.8	W +250m	5/21	37.3	0.391	0.0105			2	10%Tri		
202	6,801,416.8	355,040.0	15.1	NNW +250m	5/30	30.9	0.329	0.0106			6	on Istimus		
205	6,801,298.6	355,275.3		NE-4	5/24	27.7	0.267	0.0096			24	75%BR		
211	6,801,293.9	355,268.9	14.0	Bullrush area	8/29	22.2	0.222	0.0100		-272	25	BR channel		
204	6,801,171.0	355,283.0		E line- between 220 and 221.	8/27	32.4	0.182	0.0056		-222	33	wg/ow		
221	6,801,170.1	355,295.9	14.2	E +150	5/21	29.0	0.160	0.0055	7.9	-279	50	OW		
249	6,801,365.7	355,021.4	14.7	Between NNNW and NW	8/27	28.6	0.154	0.0054		-205	20	wg/ow		
200	6,801,163	355,132		At blind	5/21	38.7	0.140	0.0036	*		11	OW		
206	6,801,357.4	354,963.7	15.3	NW +250	5/22	34.3	0.128	0.0037	*		10	OW		
209	6,801,380.7	355,152.9		N +200	5/22	31.1	0.0822	0.0026	*		23	Edge Tri/BR		
208	6,801,325.0	355,318.9		carcass on bot.(w of ne-4	5/24	52.6	0.0800	0.0015	*		33	blister		
201	6,801,066.4	355,005.0	16.1	SW-4	5/24	32.8	0.0800	0.0024	*		0	mud/25%Tri		
200	6,801,371.6	355,059.1	15.0	NNW +200m	5/30	27.1	0.0704	0.0026	*	-195	7	OW		
207	6,801,363.0	355,088.8	14.3	Narrow back channel	8/27	33.1	0.0647	0.0020	*	-291	25	BR channel		
204	6,801,339.6	354,981.5	15.1	NW-5	5/22	31.5	0.0640	0.0020	*		12	ow/Tri patch		
203	6,801,361.7	354,999.6	14.4	Between NNNW and NW	8/27	24.7	0.0576	0.0023	*	-272	18	ow/wg		
202	6,801,307.1	355,214.0	14.3	Bullrush area	8/29	29.3	0.0469	0.0016	*	-349	37	BR end of chan		
201	6,801,216.7	355,106.0	15.3	NW +50m	5/22	38.1	0.0428	0.0011	*	-217	13	OW		
200	6,801,295.8	355,255.9	13.8	Bullrush area	8/29	42.1	0.0422	0.0010	*	-306	40	edge BR channel		
200	6,801,355.7	355,151.8		N-4	5/22	24.3	0.0415	0.0017	*		5	70%Tri		
200	6,801,360.1	354,980.4	14.8	Approaching 242	8/27	34.5	0.0411	0.0012	*		15	wg		
200	6,801,233.2	354,976.9		W of Up. Jeep	5/21	33.3	0.0357	0.0011	*	-200		OW		
200	6,801,330.7	355,150.8	15.3	N +150	5/22	28.6	0.0286	0.0010	*		10	OW		

AREA C P4 Sort

No.	UTM Coordinates (m)		Elev	Description	Date Col	Mass (g)	WP Mass (µg)	WP Conc (µg/g)	Sal (ppt)	Red (mV)	Dep (cm)	Vegetation	pH	T(C)
	North	East												
235	6,801,217.5	355,087.8	15.3	NW-2	5/22	18.7	118	6.32			11	OW		
240	6,801,322.4	354,999.4	14.3	NW +200	5/22	35.2	117	3.33	9.5	-252	45	OW		
232				N-off-208	5/22	33.7	39.0	1.16			9	BR		
280	6,801,214.3	355,183.1	15.1	NE +50	5/24	30.7	33.6	1.09				ow(1mto Hip)		
815	6,801,314.4	355,205.0	14.4	Bullrush area	8/29	29.2	32.7	1.12	3.5	-342	28	BR		12
222				New 53	5/21	31.9	22.5	0.705			45	OW		
276	old 53			blister near 53	5/24	22.8	3.39	0.149			37	blister		
802	6,801,343.4	355,323.8	14.4	Clunie shore near NE-5	8/29	20.0	2.07	0.103	2.0	-333	18	Hip,Carex, BR		
218	6,801,174.3	355,220.4	15.5	E-2	5/21	26.1	1.72	0.0659			6	20%Tri		
206	6,801,163.0	354,985.2	15.8	W +150m	5/21	27.2	0.603	0.0222			9	OW		
361	6,801,393.9	355,050.0	14.9	NNW +225m	5/30	34.2	0.564	0.0165			37			
600	6,801,316.7	355,322.4	14.1	Clunie Ck	8/29	39.6	0.435	0.0110	-302		20	ow		
846	6,801,366.6	355,041.2	14.7	Open water bwt NNW and NW	8/27	37.5	0.413	0.0110	-234		15	OW/ Tri		
255	6,801,206.0	355,145.2	15.6	near 153	5/22	29.2	0.404	0.0139			2	10%Tri		
207	6,801,162.6	354,885.1	15.8	W +250m	5/21	37.3	0.391	0.0105			6	on istmus		
302	6,801,416.8	355,040.0	15.1	NNW +250m	5/30	30.9	0.329	0.0106			24	75%BR		
288	6,801,298.6	355,275.3		NE-4	5/24	27.7	0.267	0.0096			25	BR channel		
814	6,801,293.9	355,268.9	14.0	Bullrush area	8/29	22.2	0.222	0.0100	-272		33	wg/ow		
844	6,801,171.0	355,283.0		E line- between 220 and 221.	8/27	32.4	0.182	0.0056			50	OW		
221	6,801,170.1	355,295.9	14.2	E +150	5/21	29.0	0.160	0.0055	7.9	-279	20	wg/ow		
848	6,801,365.7	355,021.4	14.7	Between NNW and NW	8/27	28.6	0.154	0.0054		-205	11	OW		
200	6,801,163	355,132		At blind	5/21	38.7	0.140	0.0036	*		10	OW		
845	6,801,357.4	354,963.7	15.3	NW +250	5/22	34.3	0.128	0.0037	*		23	Edge Tri/BR		
230	6,801,380.7	355,152.9		N +200	5/22	31.1	0.0822	0.0026	*		33	blister		
266	6,801,325.0	355,318.9		carcass on bot.(w of ne-4	5/24	52.6	0.0800	0.0015	*		0	mud/25%Tri		
304	6,801,066.4	355,005.0	16.1	SW-4	5/24	32.8	0.0800	0.0024	*	too dry	7	OW		
300	6,801,371.6	355,059.1	15.0	NNW +200m	5/30	27.1	0.0704	0.0026	*	-195	25	BR channel		
847	6,801,363.0	355,088.8	14.3	Narrow back channel	8/27	33.1	0.0647	0.0020	*	-291	12	ow/Tri patch		
241	6,801,339.6	354,981.5	15.1	NW-5	5/22	31.5	0.0640	0.0020	*	-272	18	ow/wg		
850	6,801,361.7	354,999.6	14.4	Between NNW and NW	8/27	24.7	0.0576	0.0023	*	-349	37	BR end of chan		
814	6,801,307.1	355,214.0	14.3	Bullrush area	8/29	29.3	0.0469	0.0016	*	-217	13	OW		
234	6,801,216.7	355,106.0	15.3	NW +50m	5/22	38.1	0.0428	0.0011	*	-306	40	edge BR channel		
812	6,801,295.8	355,255.9	13.8	Bullrush area	8/29	42.1	0.0422	0.0010	*		5	70%Tri		
228	6,801,355.7	355,151.8		N-4	5/22	24.3	0.0415	0.0017	*		15	wg		
801	6,801,360.1	354,980.4	14.8	Approaching 242	8/27	34.5	0.0411	0.0012	*		10	OW		
210	6,801,233.2	354,976.9		W of Up. Jeep	5/21	33.3	0.0357	0.0011	*	-200				
228	6,801,330.7	355,150.8	15.3	N +150	5/22	28.6	0.0286	0.0010	*					

AREA C P4 Sort

No.	UTM Coordinates (m)		Elev	Description	Date	Mass (g)	WP Mass (µg)	WP Conc (µg/g)	Sal (ppt)	Red (mV)	Dep (cm)	Vegetation	pH	T(C)
	North	East												
209	6,801,145.0	355,101.8	15.6	SW +50	5/24	48.1	0.0267	0.0006	9.6		5	edge mudflat		
220	6,801,171.5	355,269.5	15.2	E-3	5/21	33.4	0.0266	0.0008	*		22	BR		
224	6,801,231.1	355,146.5	15.4	N+50	5/22	29.0	0.0257	0.0009	*		13	BR		
236	6,801,251.8	355,070.5	15.3	NW +100	5/22	21.4	0.0234	0.0011	*		13	OW		
243	6,801,374.8	354,946.1	15.5	NW-6	5/22	58.5	0.0158	0.0003	*		5	10%Tri,5%Hip		
206	6,801,233.2	354,976.9	16.2	N of Up. Jeep	5/21	37.2	0.0128	0.0003	*			OW		
239	6,801,304.8	355,017.3	15.2	NW-4	5/22	23.8	0.0120	0.0005	*	-297	14	OW		
613	6,801,298.0	355,239.5	14.1	Bullrush area	8/29	24.3	0.0108	0.0004	*	-353	35	center BR chan		
263	6,801,159.0	355,163.8	15.3	SE-1	5/24	31.4	0.0107	0.0003	8.3	-248	11	BRclump		
373	6,801,348.3	355,069.6	15.0	NNW +175m	5/30	28.8	0.0059	0.0002	*		14	OW		
302	6,801,097.5	355,044.0	15.8	SW-3	5/24	26.2	0.00533	0.0002	*		0	mud		
231	6,801,408.1	355,154.1		N-5	5/22	22.9	0.00519	0.0002	8.6	-292	20	BR		

BREAD TRUCK POND SORTED

Bread Truck Pond Surface Sediment Samples Sorted by Concentration												
Sample	UTM Coordinates		Elev	Location	Sample Date	Sample Mass	WP Mass per Subsamp.	WP Conc.	Salinity	Redox	Wat. Depth	Vegetation
	(m)		(ft)			(g)	(µg)	(µg/g)	ppt	(mv)	(cm)	pH T
248	6,801,819.3	354,530.0	15.40	BT+75	5/22/91	34.86	2008	57.6		-249	8	OW
359	6,801,804.8	354,499.6	16.30	NW + 150	5/29/91	25.92	873	33.7	18	-329	15	OW
361	6,801,778.2	354,541.7	16.55	NW+200 (center)	5/29/91	26.00	275	10.6		t.d	5	OW
526	6,801,817.3	354,530.0		2 m S of 248	8/26/91	33.8	259	7.67				OW
494	6,801,780.5	354,539.7		bet 250 and 361	8/23/91	35.7	140	3.92		-285	10	OW
525	6,801,819.3	354,528.0		2 m W of 248	8/26/91	37.3	22.7	0.608		t.d		OW
250	6,801,781.0	354,536.6	15.70	BT+125	5/22/91	24.36	14.1	0.579	17.1	-263	8	OW
253	6,801,726.0	354,547.5	15.24	BT+200	5/22/91	30.66	8.54	0.279			15	OW
251	6,801,762.6	354,540.4	15.56	BT+150	5/22/91	34.52	8.80	0.255			9	OW
532	6,801,936	354,461		North Mudflat	8/26/91	38.0	5.64	0.148		-205	4	OW
493	6,801,783.6	354,539.7	15.43	Pond center (250-488-361)	8/23/91	29.8	2.02	0.0679		-327	10	WG/black speck
484	6,801,760.1	354,447.7	15.86	E-W +75	8/23/91	34.5	2.00	0.0580	7.0	-275	8	mudpond
486	6,801,782.6	354,543.6	15.64	E-W +175 (center)	8/23/91	34.4	1.82	0.0529		-355	7	black specks
362	6,801,764.7	354,563.0	16.64	NW+225	5/29/91	29.23	1.42	0.0485			10	OW
496	6,801,775.3	354,548.8		Between 361 and 362	8/23/91	28.7	0.746	0.0260		-295	10	OW
527	6,801,819.3	354,532.0		2 m E of 248	8/26/91	32.5	0.770	0.0237		t.d.		OW
487	6,801,778.5	354,520.1	15.42	E-W +150	8/23/91	5.8	0.118	0.0203		-367		OW
360	6,801,791.2	354,521.0	16.28	NW+175	5/29/91	33.33	0.536	0.0161			25	OW
255	6,801,687.6	354,553.5	15.86	BT+250	5/22/91	25.93	0.268	0.0103				OW
524	6,801,821.3	354,530.0		2 m N of 248	8/26/91	34.1	0.329	0.0097		-236		OW
486	6,801,774.3	354,495.1	16.22	E-W +125	8/23/91	36.6	0.302	0.0083		-291	8	OW
490	6,801,788.4	354,568.2	15.64	E-W +225	8/23/91	26.4	0.200	0.0076		-365	15	Hip/WG
249	6,801,799.5	354,532.8	15.31	BT+100	5/22/91	32.81	0.149	0.0046			20	OW
364	6,801,737.9	354,605.7	14.91	NW+275	5/29/91	78.26	0.336	0.0043			15	BR
247	6,801,840.2	354,526.0	15.46	BT+50	5/22/91	25.19	0.0501	0.0020	*		5	OW
248	6,801,859.6	354,522.2	15.42	N-S line BT+25m	5/22/91	33.39	0.0511	0.0015	*		5	pond edge
485	6,801,777.2	354,538.5	14.90	Crater 3m from 493	8/23/91	30.6	0.0402	0.0013	*	-400	33	OW
358	6,801,817.9	354,478.3	15.62	NW+125m	5/29/91	34.75	0.0364	0.0010	*		5	OW
252	6,801,744.5	354,543.7	15.16	BT+175	5/22/91	33.80	0.0351	0.0010	*		13	OW
485	6,801,768.8	354,470.9	16.10	E-W +100	8/23/91	39.6	0.0202	0.0005	*	-331	5	OW
254	6,801,706.9	354,550.1	15.51	BT+225	5/22/91	35.77	0.0146	0.0004	*	-239	5	OW
481	6,801,791.8	354,589.1	15.69	E-W +250	8/23/91	33.7	0.0094	0.0003	*	-286	13	Hip
489	6,801,782.7	354,543.7		E-W +200	8/23/91	38.9	0.0105	0.0003	*	-419		bilister
												20.0