

US Army Corps  
of Engineers®

**Remediating and Monitoring  
White Phosphorus Contamination  
at Eagle River Flats  
(Operable Unit C),  
Fort Richardson, Alaska**

**FY 00 Report**

**Cold Regions Research and  
Engineering Laboratory  
72 Lyme Road • Hanover • New Hampshire 03755**

# Report Documentation Page

Form Approved  
OMB No. 0704-0188

Public reporting burden for the collection of information is estimated to average 1 hour per response, including the time for reviewing instructions, searching existing data sources, gathering and maintaining the data needed, and completing and reviewing the collection of information. Send comments regarding this burden estimate or any other aspect of this collection of information, including suggestions for reducing this burden, to Washington Headquarters Services, Directorate for Information Operations and Reports, 1215 Jefferson Davis Highway, Suite 1204, Arlington VA 22202-4302. Respondents should be aware that notwithstanding any other provision of law, no person shall be subject to a penalty for failing to comply with a collection of information if it does not display a currently valid OMB control number.

1. REPORT DATE <b>AUG 2001</b>		2. REPORT TYPE		3. DATES COVERED -	
4. TITLE AND SUBTITLE <b>Remediating and Monitoring White Phosphorus Contamination at Eagle River Flats (Operable Unit C), Fort Richardson, Alaska</b>				5a. CONTRACT NUMBER	
				5b. GRANT NUMBER	
				5c. PROGRAM ELEMENT NUMBER	
6. AUTHOR(S)				5d. PROJECT NUMBER	
				5e. TASK NUMBER	
				5f. WORK UNIT NUMBER	
7. PERFORMING ORGANIZATION NAME(S) AND ADDRESS(ES) <b>Cold Regions Research and Engineering Laboratory, 72 Lyme Road, Hanover, NH, 03755</b>				8. PERFORMING ORGANIZATION REPORT NUMBER	
9. SPONSORING/MONITORING AGENCY NAME(S) AND ADDRESS(ES)				10. SPONSOR/MONITOR'S ACRONYM(S)	
				11. SPONSOR/MONITOR'S REPORT NUMBER(S)	
12. DISTRIBUTION/AVAILABILITY STATEMENT <b>Approved for public release; distribution unlimited</b>					
13. SUPPLEMENTARY NOTES <b>The original document contains color images.</b>					
14. ABSTRACT <b>see report</b>					
15. SUBJECT TERMS					
16. SECURITY CLASSIFICATION OF:			17. LIMITATION OF ABSTRACT	18. NUMBER OF PAGES <b>94</b>	19a. NAME OF RESPONSIBLE PERSON
a. REPORT <b>unclassified</b>	b. ABSTRACT <b>unclassified</b>	c. THIS PAGE <b>unclassified</b>			

**Remediating and Monitoring  
White Phosphorus Contamination  
at Eagle River Flats  
(Operable Unit C),  
Fort Richardson, Alaska**

**FY 00 Report**

**August 2001**

**Prepared for**

**U.S. ARMY, ALASKA  
DIRECTORATE OF PUBLIC WORKS  
William A. Gossweiler, Remedial Project Manager  
and  
U.S. ARMY ENGINEER DISTRICT, ALASKA  
JoAnn T. Walls, Project Engineer**

**Prepared by**

**U.S. ARMY ENGINEER RESEARCH AND DEVELOPMENT CENTER,  
COLD REGIONS RESEARCH AND ENGINEERING LABORATORY  
Charles M. Collins and David W. Cate, Report Editors**

**REMIEDIATING AND MONITORING WHITE PHOSPHORUS CONTAMINATION  
AT EAGLE RIVER FLATS (OPERABLE UNIT C), FORT RICHARDSON, ALASKA**

FY 00 REPORT

August 2001

Prepared for

U.S. ARMY, ALASKA  
DIRECTORATE OF PUBLIC WORKS  
William A. Gossweiler, Remedial Project Manager  
and  
U.S. ARMY ENGINEER DISTRICT, ALASKA  
JoAnn T. Walls, Project Engineer

Prepared by

U.S. ARMY ENGINEER RESEARCH AND DEVELOPMENT CENTER,  
COLD REGIONS RESEARCH AND ENGINEERING LABORATORY  
Charles M. Collins and David W. Cate, Report Editors

**CONTRIBUTORS**

**M.E. Walsh, C.H. Racine, C.M. Collins, M.R. Walsh, R.N. Bailey, C.R. Williams, G.M. Trachier**  
U.S. Army Engineer Research and Development Center,  
Cold Regions Research and Engineering Laboratory

**W.D. Eldridge**  
U.S. Fish and Wildlife Service, Division of Migratory Bird Management, Anchorage, AK

**Points of Contact:**

W.A. Gossweiler  
Director of Public Works  
600 Richardson Drive #6500  
ATTN: APVR-PW-ENV  
Fort Richardson, Alaska 99505  
(907) 384-3017  
(907) 384-3047 Fax

Charles M. Collins  
CRREL  
72 Lyme Road  
Hanover, NH 03755  
(907) 353-5180  
(907) 353- 5142 Fax

# TABLE OF CONTENTS

<b>I. EXECUTIVE SUMMARY .....</b>	<b>1</b>
 <b>II. RISK ASSESSMENT</b>	
II-1. Waterbird Utilization of Eagle River Flats: April–October 2000 <i>William D. Eldridge .....</i>	7
 <b>III. REMEDIATION AND MONITORING STUDIES</b>	
III-1. Eagle River Flats Pond Pumping Remediation Project: Second-Year Deployment under the Record of Decision <i>Michael R. Walsh and Charles M. Collins .....</i>	19
III-2. Treatment Verification: Monitoring the Remediation of White-Phosphorus-Contaminated Sediments In Treated Ponds <i>Marianne E. Walsh, Charles M. Collins, and             Ronald N. Bailey .....</i>	37
III-3. Composite Sampling and Analysis for White Phosphorus in Untreated Ponds <i>Marianne E. Walsh, Charles M. Collins, and             Ronald N. Bailey .....</i>	63
III-4. 2000 Weather Data for Eagle River Flats <i>Charles M. Collins.....</i>	71
III-5. Eagle River Flats Wireless Remote Imaging System <i>Christopher R. Williams and Gary M. Trachier .....</i>	79
 <b>IV. EAGLE RIVER FLATS SPATIAL DATABASE</b>	
IV-1. Eagle River Flats Database and Environmental Change Monitoring <i>Charles H. Racine .....</i>	87

# I. EXECUTIVE SUMMARY

## INTRODUCTION

This is the eleventh annual contract report prepared by researchers from CRREL and other Federal agencies for U.S. Army Engineer District, Alaska, and U.S. Army Alaska, Public Works, describing the results of research, monitoring, and remediation efforts addressing the white phosphorus contamination in Eagle River Flats, an 865-ha estuarine salt marsh on Fort Richardson, Alaska. Fort Richardson is on the National Priority List, and Eagle River Flats is designated Operable Unit C (OU-C) under the *Comprehensive Environmental Response, Compensation, and Liability Act (CERCLA)*.

This year marks the second of a planned five-year remediation effort in Eagle River Flats. Pond pumping, using six remote-controlled pumps to temporarily drain contaminated ponds within several areas of Eagle River Flats, was conducted again this year. The pumps kept the ponds drained for an extended period during the summer, allowing the pond bottom sediments to dry and the white phosphorus to sublime and oxidize. The logistics continued to be fine-tuned, leading to a more effective and efficient operation this year.

The combination of a warm, dry period during the first half of the summer and the successful use of flood gates to prevent flooding tides resulted in a long and effective drying season. Sampling showed that levels of contamination continued to decline, although localized areas of contamination still exist.

## **II-1. WATERBIRD UTILIZATION OF EAGLE RIVER FLATS FROM AERIAL SURVEYS: APRIL–OCTOBER, 2000**

William D. Eldridge

Aerial surveys to monitor waterbird use of Eagle River Flats (ERF) during the spring, summer, and fall of 2000 were conducted by the U.S. Fish and Wildlife Service as part of the ongoing waterbird mortality and monitoring studies of ERF sponsored by the U.S. Army at Ft. Richardson, Anchorage, Alaska. Numbers of waterbirds were counted or estimated, recorded by species or species group, and classified by locations on ERF using standardized study areas.

ERF experienced an earlier breakup in 2000 than in 1999, which was a late year. The first half of the summer of 2000 was generally dry, and ERF ponds were low or dry, similar to water conditions throughout Cook Inlet. Extensive pumping was effective in drying large portions of ERF in 2000. After pumping ceased in mid-August, ponds gradually refilled in most areas. Fall high tides did not occur until early October in 2000.

Tundra and trumpeter swans utilized ERF only in small numbers during the spring of 2000; in fall, swan numbers peaked in mid-September at 189 birds, lower than in other recent years except 1999. Peak counts of geese occurred on 27 April, primarily lesser snow geese; fall goose migration was similar to other years except that fewer geese used ERF. Duck species utilizing ERF in 2000 were similar to other years. The mean number of ducks per survey during summer, 127, was lower than the 1988–1997 mean of 190. The mean number of ducks observed in the fall, 435, was considerably lower than the 1988–1997 mean of 836 and is the third year in a row of markedly lower fall numbers. This trend is likely related to the effects of pumping and draining on both the amount of habitat available and the food resources. Numbers of bald eagles were low in 2000, similar to recent years. Numbers of shorebirds were lower than in recent years. The mew gull colony, formerly in Area D, now consists of just a few pairs. No breeding sandhill cranes were observed on ERF in 2000.

## **III-1. EAGLE RIVER FLATS POND PUMPING REMEDIATION PROJECT: SECOND-YEAR DEPLOYMENT UNDER THE RECORD OF DECISION**

Michael R. Walsh and Charles M. Collins

The 2000 field season is the second year of the remediation phase of the Eagle River Flats project. This year, tidal predictions indicated a very poor attenuation year at the Flats due to monthly inundation during lunar high tides. However, due to the effectiveness of the tide gates in Areas C and A, a successful treatment season occurred in Areas C and A. Work continued at improving logistics, improving equipment reliability, and addressing contaminated areas adjacent to treated areas.

Deployment of the pump units was the same this year as last, with two units in Area A (Ponds 256 and 258), three units in Area C (Ponds 146, 155, and 183), and one unit in the C/D Area (Pond 730). The tide gates prevented flooding during a critical tidal cycle in early June, when we pre-

vented flooding during the 32.3-ft event, 1.2 ft above normal flood stage. This gave us a 52-day contiguous non-flooded period during the critical first months of the season when rainfall is low and attenuation conditions are at their best. Significant drying occurred in the A Ponds for the first time, and results from all ponds except Pond 730 indicate this was a very successful season.

Logistics continue to be refined, with an emphasis on optimizing the utilization of helicopters when on site. Deployment of the discharge line and heavy equipment is now accomplished in one day. Sling loading the pipe in and out of the Flats has proved to be quite effective, although there were problems getting the right helicopter for the job. The heavy equipment aerial transfer operations are going quite smoothly, with Weldin, CRREL, and the National Guard all contributing to the effort. In August, all the equipment was transferred to the EOD Pad by 1430 hours, even though we had more equipment in the field than we have ever had for the project. As a result of preventing flooding in June and optimizing flight time with the commercial helicopter, \$40,000 was saved on that contract. The money will go towards a badly needed overhaul of the generator sets this fall and to exercise the gensets over the winter.

A team from Weldin Construction, Inc., led by Terry Edwards, conducted the field operation and maintenance work again this year. The results were excellent, and again no significant unplanned downtime occurred. The controls were once again reconfigured and rewired to address stuck float switches. This will also increase the reliability of the systems, as the controls were simplified in the process. A revised video monitoring system was deployed with very good results and was used throughout the season to monitor conditions in both Area A and Area C. The meteorological site was once again operational and accessible over the internet at the Flats web site.

Next season looks to finally be favorable for remediation at the Flats. Moderate flooding tides in mid-July may be contained by the tide gates, and major flooding tides will not occur until mid-August. A determination, based on sampling work, will have to be made on where the systems will need to be deployed next season, and additional blasting work will need to be done to address areas found to be contaminated this year. The purchase of light-weight, single-wall fuel transfer tanks capable of being lifted by the A-Star helicopter is anticipated to further reduce helicopter expense.

### **III-2. TREATMENT VERIFICATION: MONITORING THE REMEDIATION OF WHITE-PHOSPHORUS-CONTAMINATED SEDIMENTS IN TREATED PONDS**

Marianne E. Walsh, Charles M. Collins, and Ronald N. Bailey

The in-situ decontamination of white-phosphorus-contaminated sediments at ERF by pond pumping was monitored again with the three part approach we developed in 1997. To see if pond pumping produced conditions favorable for sublimation/oxidation of white phosphorus particles, we used dataloggers to record sediment moisture and temperature, and we measured residual white phosphorus from particles we planted in the sur-



face sediment. Also, we re-sampled previously identified hot spots to see if the white phosphorus concentrations had declined.

The main pond of Area C (Pond 183) has been pumped for four consecutive seasons. This year (2000), the pond was dewatered by pumping in early May and the sediments dried significantly until a series of flooding tides July 2 to 4. Sediments remained wet through July and August due to frequent precipitation and tidal flooding in August. Despite cool surface sediment temperatures (mean of 14.8°C) during the time that the sediment was unsaturated, we measured a 56% loss of mass of the white phosphorus particles we planted in May 2000 and recovered in August 2000. White phosphorus concentration the middle of Area C (C100 m grid), as determined by composite sampling, has declined from 0.07 µg/g in June 1997 to 0.00055 µg/g in August 2000. A milestone was reached at Miller's Hole, the crater produced when a white phosphorus-containing UXO was detonated on 20 May 1992. In samples of the surface sediment collected from the bottom of the crater in August 2000, white phosphorus was undetectable for the first time since we began sampling the crater when the concentration was over 2000 µg/g. However, Pond 183 is not completely decontaminated. White phosphorus is still detectable in discrete samples collected from the DWRC Pen 5, although only four samples have concentrations greater than 0.001 µg/g (in 1996 all 48 samples were greater than 0.001 µg/g). A few more favorable drying seasons should complete the decontamination of Pond 183.

We installed a datalogger and resampled Pond 146, adjacent to Canoe Point in Area C, in an area that was dredged in 1996 but still had high white phosphorus concentrations in 1999. Particles planted in Pond 146 declined in mass by 27%; composite samples showed a greater loss, with one sample declining from 7.31 µg/g in June 1999 to 0.001 µg/g in August 2000.

Pond 155, to the Northeast of Pond 183 in Area C, is located within a bulrush marsh, and the sediments do not dry significantly. This year, planted particles did show a 32% decrease in mass, as compared to last year when no change was found. A grid for collecting composite samples was established in 1998, but no decline in white phosphorus concentration is evident.

Ponds 258 and 256 in Area A were drained for the third consecutive season and both showed drying and a decline in the mass of planted white phosphorus particles of 89 and 92%, respectively.

Pond 730 in Area C/D was drained by pumping for the second year, but minimal drying occurred because of frequent flooding from the Bread Truck ditch. Pond 75 in Coastal East was drained this year because we found white phosphorus in a composite sample collected in 1999. This pond also floods from the Bread Truck ditch and minimal drying occurred.

The former Bread Truck pond experienced 20 flooding tides between June and August, which eroded more of the pond and further enlarged the blasted ditch. After the flooding tides at the beginning of June, both the north and south sides of the pond dried. Planted white phosphorus declined by 79% and 32% for the north and south sides, respectively. White phosphorus is barely detectable in the composite samples collected from the north and south sides of the pond.

Because of the death of telemetry birds in the Aquablok treated pond (#285) on Racine Island, we were asked to take composite samples of the

surface sediment for white phosphorus analysis. We collected five composites, all of which were positive with white phosphorus concentrations ranging from 0.023 to 6.90  $\mu\text{g/g}$ . We also collected eight discrete samples, two of which were blank, and the remaining six ranged from 0.00014 to 6.38  $\mu\text{g/g}$ . This pond needs further remediation.

### **III-3. COMPOSITE SAMPLING AND ANALYSIS FOR WHITE PHOSPHORUS IN UNTREATED PONDS**

Marianne E. Walsh, Charles M. Collins, and Ronald N. Bailey

Mortality of telemetry mallards indicates that localized areas of contamination (hotspots) may still be present in Northern C, Area C/D, and possibly Area A. In 2000, we continued to collect composite samples from Areas A and C/D where previous sampling was sparse or non-existent. We also sampled some small open water pools within the marsh of Area C and the northern part of Pond 146, which is undrained. All of the new samples in Areas A and C/D were blank. In Area C, one composite sample from the marsh was positive; white phosphorus concentration was 0.03  $\mu\text{g/g}$ . This concentration is high enough to be of concern.

### **III-4. 2000 WEATHER DATA FOR EAGLE RIVER FLATS**

Charles M. Collins

May and June are normally the driest months of the core drying season needed for treating contaminated pond bottom sediments. This year the timing of the last spring flooding tide in early May allowed us to deploy equipment and pump the ponds out so that we could take advantage of the warmer temperatures of late May to start the drying process. June and early July provided nearly ideal drying conditions except for an occasional rainstorm.

The summer of 2000 had normal to slightly above-normal temperatures for May and June. There were thirty-eight days from mid-May to mid-August 2000 with maximum temperatures of 20°C or more. This compares to only thirty days during the summer of 1999 and only eighteen days during the summer of 1998. Temperatures were below normal for August and September.

Precipitation was minimal from late May through almost all of June, with a precipitation total from 24 May through 28 June of only 8 mm. Thirteen of the days with maximum temperatures of 20°C or more also occurred in this dry spell, contributing to the excellent sediment drying conditions during this period.

### **III-5. EAGLE RIVER FLATS WIRELESS REMOTE IMAGING SYSTEM**

Christopher R. Williams and Gary M. Trachier

A remote imaging system proved to be useful for monitoring the daily operations of the Pond Pumping Remediation Project at Eagle River Flats.

By visually inspecting the daily retrieved images from the remote imaging systems, project managers could monitor the effectiveness of the pumping remediation efforts. Retrieving images from ERF proved to be difficult during the 1999 field season. We analyzed the shortcomings and designed a new robust image retrieval system from the bottom up. The new system, based on wireless technology, was deployed in two ponded areas under treatment.

The retrieved images were successfully used throughout the 2000 field season to monitor the conditions of the pumping remediation efforts. The images that were retrieved and posted to the ERF Web site proved to be invaluable. The images allowed project managers to view the effects of the pumping remediation operations, the drying of soil, the tidal activity, and the flooding events at the Flats. It is apparent that a variety of new applications are possible with the success of the remote imaging system.

#### **IV-1. EAGLE RIVER FLATS DATABASE AND ENVIRONMENTAL CHANGE MONITORING**

Charles Racine

We entered into the database the locations and white phosphorus concentrations for all sediment samples obtained during 2000 so that the database now includes all samples analyzed for white phosphorus from the beginning of the project in 1991 to September 2000. This includes over 3000 point samples and 300 composite samples. During the past year the entire database was transferred to the USARAK GIS, a large database used by the Ft. Richardson DPW environmental branch to manage contamination and clean-up efforts on the U.S. Army facilities in Alaska. During 2000 we developed a CD that contains all of the telemetry data from 1996 to 1999. (In 2000 no telemetry took place.) We also produced maps to show additional erosion of the ditch draining the Bread Truck Pond.

## II-1. WATERBIRD UTILIZATION OF EAGLE RIVER FLATS FROM AERIAL SURVEYS: APRIL–OCTOBER, 2000

**William D. Eldridge**

U.S. Fish and Wildlife Service, Anchorage, AK

### INTRODUCTION

Aerial surveys to monitor waterbird use of Eagle River Flats (ERF) during the spring, summer, and fall of 2000 were conducted by the U.S. Fish and Wildlife Service as part of the ongoing waterbird mortality and monitoring studies of ERF sponsored by the U.S. Army at Ft. Richardson, Anchorage, Alaska. The purpose and history of these investigations have been presented elsewhere (Racine and Cate 1996).

### STUDY AREA

Eagle River Flats is a salt marsh complex comprising 870 ha located on the south side of Knik Arm, approximately 10 km east of Anchorage (Fig. II-1-1). A detailed description of this area is presented in Racine and Cate (1996).

### METHODS

Aerial surveys of ERF were flown from April through October 2000. Surveys were conducted more frequently in fall than in

spring and summer. Surveys were flown using a fixed-wing aircraft at an airspeed of 100–120 km/hr and an altitude of 70–75 m. Total coverage of ERF was obtained by overlapping transects. Numbers of waterbirds were counted or estimated and recorded by species or species group with a cassette tape recorder. Waterfowl numbers were classified by locations on ERF, using standardized study areas (Fig. II-1-1). When possible, birds were also recorded by individual ponds within each study area, using a standardized pond numbering system. Areas of permanent and intermittent study ponds were obtained from digitized maps provided by CRREL and used to convert bird numbers to densities within the study areas.

### RESULTS AND DISCUSSION

#### Moisture conditions

ERF experienced an earlier breakup in 2000 than in 1999, which was a late year. ERF was approximately 85% snow covered by 21 April 2000. By 27 April there was 40% snow cover, but most ponds were frozen because of cold nights. By 3 May ERF was approximately 10% snow covered, and ponds were 30% frozen.

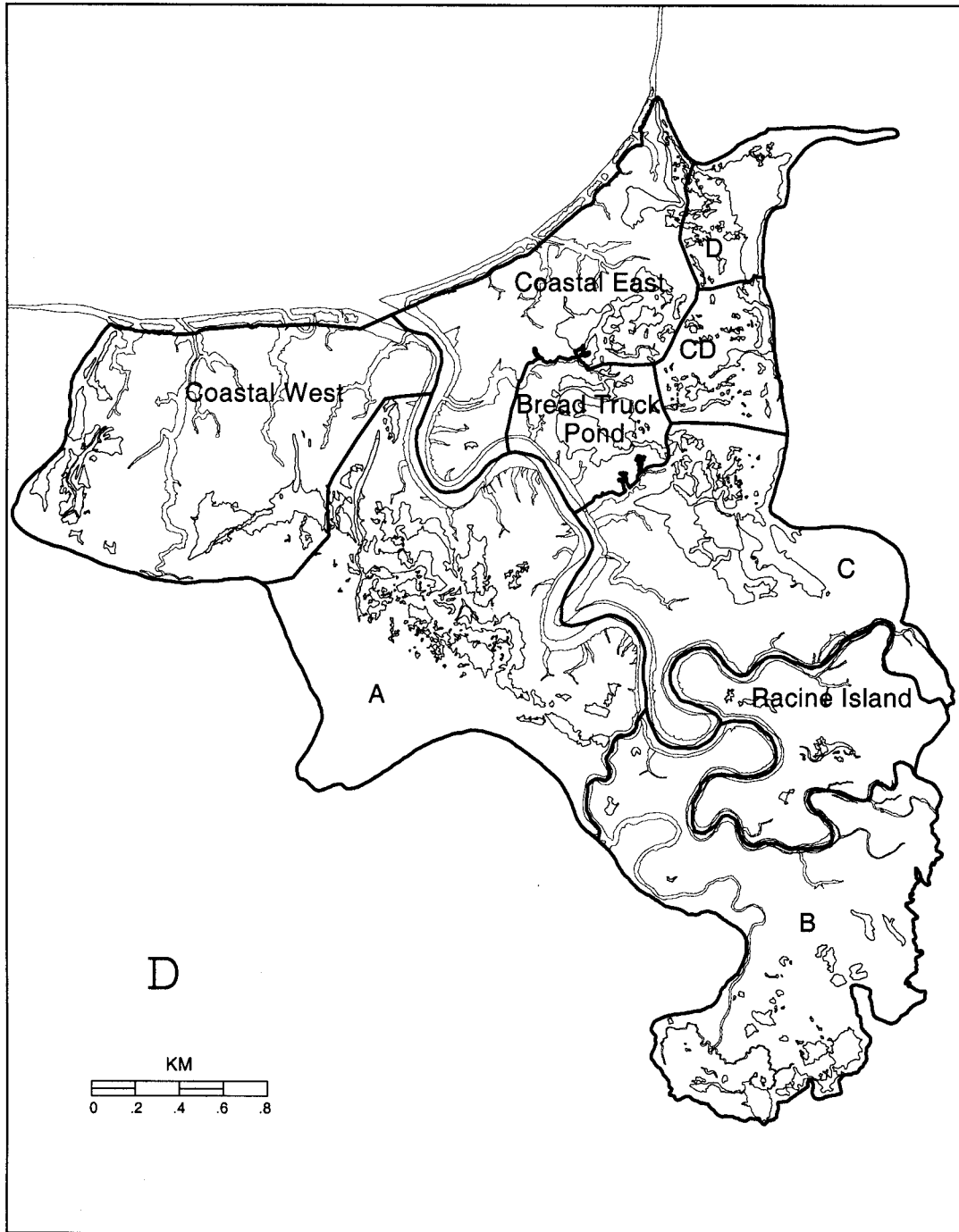

Figure II-1-1. Standardized ERF study areas surveyed for waterfowl.

The first half of the summer of 2000 was generally dry, and ERF ponds were low or dry, similar to water conditions throughout Cook Inlet. Frequent flood tides put water into ERF but drained off rapidly. Extensive pumping was effective in drying large portions of ERF in 2000. After pumping ceased in mid-August, ponds gradually refilled in most areas. Fall high tides, which generally occur in late August or early September, did not occur until early October in 2000. The ponds on ERF began freezing, with periods of thawing, in mid-October.

#### Abundance and distribution of waterbirds on ERF

Twenty-four aerial surveys were conducted in 2000, somewhat less than in recent years, but a comparable number of fall surveys were flown. Numbers of birds by species or species groups are listed by survey date in Table II-1-1 and Figure II-1-2. Utilization of ERF study areas by major waterfowl groups by season is presented in Tables II-1-2 and II-1-3. A discussion of utilization of ERF by species

or species groups of waterbirds is presented below.

#### Swans

Tundra swans (*Columbus columbianus*) and/or trumpeter swans (*C. buccinator*) utilized ERF only in small numbers during the spring of 2000, with 4 observed on 27 April (Table II-1-1). Higher swan numbers in spring may have been missed because of the small number of surveys. Swans were observed in Areas B and D, similar to other years (Fig. II-1-3).

In fall, swan numbers peaked in mid-September at 189 birds, lower than in other recent years except 1999. The fall mean of 28 swans was among the lowest recorded since surveys began in 1988. Swans utilized Areas D, B, and CD most during fall (Fig. II-1-3), as in other years. One dead swan was observed in Area D, pond number 5, during fall surveys.

#### Geese

Peak counts of geese occurred on 27 April, primarily lesser snow geese (*Chen caerulescens caerulescens*) (Table II-1-1, Fig. II-1-4). Snow

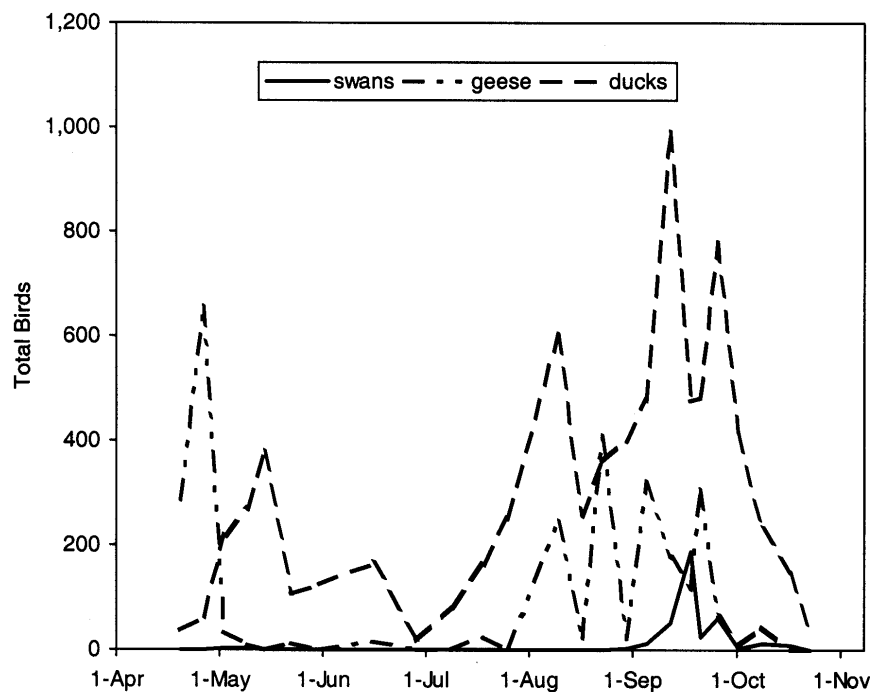

Figure II-1-2. Numbers of swans, geese, and ducks counted on ERF during aerial surveys in 2000.

**Table II-1-1. Number of birds, by species or species group, observed during aerial surveys of ERF in 2000.**

	4/20	4/27	5/3	5/10	5/15	5/23	5/31	6/16	6/29	7/9	7/26	8/10
<b>Swans</b>	0	0	4	4	0	0	0	0	0	0	0	0
<b>Geese</b>												
Greater white-fronted	0	5	21	9	0	0	0	0	0	0	0	7
Lesser snow	181	525	0	0	0	0	0	0	0	0	0	0
Canada	105	125	11	0	0	11	0	15	0	0	0	238
Subtotal geese	286	655	32	9	0	11	0	15	0	0	0	245
<b>Ducks</b>												
Green-winged teal	5	0	32	67	165	25	18	0	0	0	22	205
Mallard	2	9	54	80	80	35	18	99	13	23	127	161
Northern pintail	25	51	100	51	49	17	18	0	0	2	37	55
Nothern shoveler	0	0	12	21	12	17	45	0	0	0	0	0
American wigeon	5	0	20	48	73	10	22	64	4	57	62	183
Gadwall	0	0	0	0	0	0	4	0	0	0	0	0
Greater scaup	0	0	0	0	0	2	0	0	0	0	0	0
Unidentified ducks	0	0	0	0	0	0	0	0	0	0	0	0
Subtotal ducks	37	60	218	267	379	106	125	163	17	82	248	604
<b>Other birds</b>												
Bald eagle	2	4	0	0	0	0	1	0	1	0	0	0
Raptor	0	0	0	0	0	0	0	0	0	0	0	0
Sandhill crane	0	13	5	0	0	2	18	6	7	0	10	0
Shorebird	0	0	0	6	46	0	58	0	0	0	238	16
Gull	0	19	46	51	42	31	74	175	19	29	17	8
Arctic tern	0	0	0	0	5	20	16	21	13	6	0	0
Common raven	2	0	0	0	0	0	0	0	0	0	0	0

**Table II-1-2. Mean numbers of waterfowl groups in 2000 by season. The number of complete surveys used to classify observations by area for spring, summer, and fall were 7, 5, and 13, respectively.**

	Coastal West	A	B	Racine Island	C	CD	Bread Truck	Coastal East	D
<b>Spring</b>									
Swans	0.0	0.0	0.3	0.0	0.0	0.0	0.0	0.3	0.6
Geese	95.1	7.4	10.7	0.0	17.3	0.4	4.3	6.6	0.0
Greater white-fronted	0.0	0.0	3.9	0.0	0.0	0.4	0.7	0.0	0.0
Lesser snow	80.0	7.1	0.0	0.0	12.1	0.0	0.0	1.6	0.0
Canada	15.1	0.3	6.9	0.0	5.1	0.0	3.6	5.0	0.0
Ducks	28.0	43.7	26.4	2.1	15.0	25.1	2.7	6.9	20.3
<b>Summer</b>									
Swans	0.0	0.0	0.0	0.0	0.0	0.0	0.0	0.0	0.0
Geese	0.0	1.2	0.0	0.0	3.6	0.0	0.0	3.0	0.0
Greater white-fronted	0.0	0.0	0.0	0.0	0.0	0.0	0.0	0.0	0.0
Lesser snow	0.0	0.0	0.0	0.0	0.0	0.0	0.0	0.0	0.0
Canada	0.0	1.2	0.0	0.0	3.6	0.0	0.0	3.0	0.0
Ducks	9.2	26.8	23.8	1.6	0.8	19.4	0.0	16.8	36.6
<b>Fall</b>									
Swans	0.0	0.5	4.6	0.0	0.2	2.7	0.0	4.2	15.8
Geese	53.0	16.0	0.6	1.5	1.0	0.2	11.0	49.9	0.0
Greater white-fronted	0.0	0.5	0.6	0.0	0.0	0.2	0.0	0.3	0.0
Lesser snow	0.0	0.0	0.0	0.0	0.0	0.0	0.0	0.0	0.0
Canada	53.0	15.5	0.0	1.5	1.0	0.0	11.0	49.6	0.0
Ducks	34.4	102.4	82.7	3.1	43.5	39.2	15.9	28.7	85.7

Table II-1-1 (continued).

	8/17	8/23	8/30	9/5	9/12	9/18	9/21	9/26	10/2	10/9	10/17	10/23
<b>Swans</b>	0	0	2	12	52	189	23	62	3	11	10	0
<b>Geese</b>												
Greater white-fronted	8	0	6	0	0	0	0	0	0	0	0	0
Lesser snow	0	0	0	0	0	0	0	0	0	0	0	0
Canada	13	408	16	320	176	119	305	64	8	45	0	0
Subtotal geese	21	408	22	320	176	119	305	64	8	45	0	0
<b>Ducks</b>												
Green-winged teal	65	27	76	30	44	31	79	67	14	7	4	0
Mallard	79	191	156	81	45	175	214	281	396	221	144	42
Northern pintail	41	41	117	91	0	91	85	156	0	2	0	0
Northern shoveler	0	0	0	0	0	0	0	0	0	0	0	0
American wigeon	47	102	52	93	2	120	42	87	0	0	0	0
Gadwall	0	0	0	0	0	0	0	0	0	0	0	0
Greater scaup	0	0	0	0	0	0	0	14	0	0	0	0
Unidentified ducks	23	0	0	182	900	58	61	175	6	0	0	0
Subtotal ducks	255	361	401	477	991	475	481	780	416	230	148	42
<b>Other birds</b>												
Bald eagle	0	0	2	0	0	0	0	0	0	1	0	0
Raptor	0	0	0	0	3	0	0	0	0	0	0	0
Sandhill crane	0	13	4	4	20	0	0	0	0	0	0	0
Shorebird	12	35	7	0	0	0	0	0	0	0	0	0
Gull	28	0	19	0	0	0	7	0	0	0	0	0
Arctic tern	0	0	0	0	0	0	0	0	0	0	0	0
Common raven	0	0	0	0	0	0	0	0	0	5	0	0

geese comprised 71% of the total geese counted in spring, followed by Canada geese (*Branta canadensis*). Geese utilized Area Coastal West most in spring (Fig. II-1-4).

A small number of Canada geese used ERF during the summer for nesting or brood-rearing (Table II-1-1), with most use occurring along the riverbanks of Area C (Fig. II-1-4). Fall goose migration was similar to other years except that fewer geese used ERF. Peaks occurred in mid-September and early October, with heaviest utilization of Areas Coastal East and Coastal West (Table II-1-1, Fig. II-1-

4). Tule white-fronted geese (*Anser albifrons frontalis*) were observed in small numbers in fall. Snow geese were not observed but generally do not migrate through Cook Inlet in fall.

#### Ducks

Duck species utilizing ERF in 2000 were similar to other years (Table II-1-1). Dabbling ducks comprised 99% of the ducks counted through the season. Mallards (*Anas platyrhynchos*), American wigeon (*A. americana*), American green-winged teal (*A. crecca*), and northern pintail (*A. acuta*) were

Table II-1-3. Percent duck use of major habitat types by season on ERF in 2000.

	(n)	Ponds	Knik Shoreline	Eagle River	Tidal Sloughs
Spring	(1192)	62	0	4	0
Summer	(675)	60	0	12	0
Fall	(5661)	77	3	7	<1



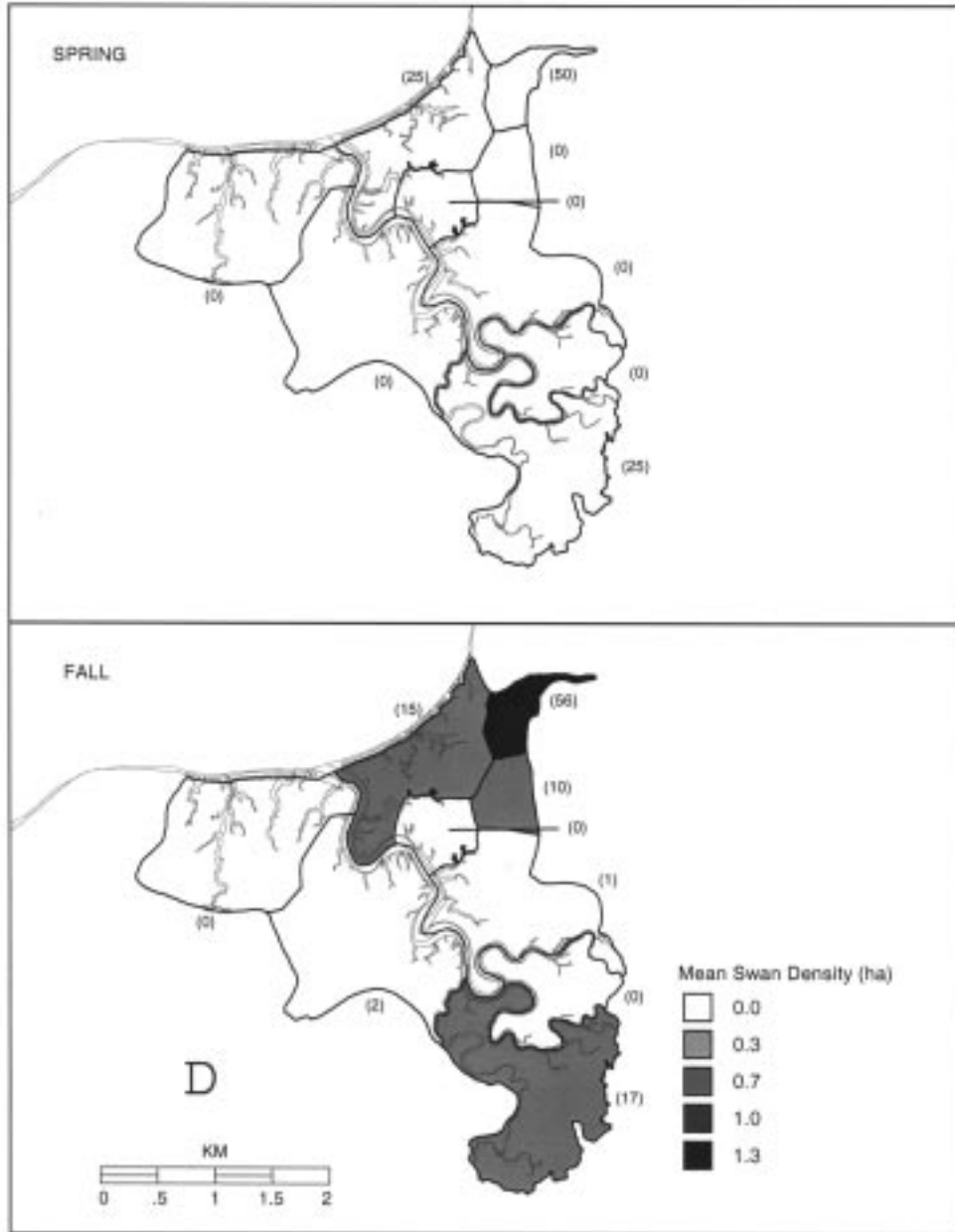

Figure II-1-3. Mean densities of swans on ERF study areas in spring and fall 2000. Numbers in parentheses are the percent of total swans observed in each area. The area (ha) of permanent and intermittent ponds in each area was used to calculate densities.

the most common species. Of the four major habitat types used to classify duck locations, ponds were the most important (Table II-1-3). Numbers of all species of ducks combined are presented for 1991–2000 in Figure II-1-5. It is clear that in 2000, ERF supported fewer ducks than in previous years.

In spring the number of ducks peaked on 15 May (Table II-1-1, Fig. II-1-5). Ducks spent little time on ERF during April or May. Ducks utilized Areas A and Coastal West most in spring, but the highest density was recorded in Area C/D (Fig. II-1-6).

The mean number of ducks per survey dur-

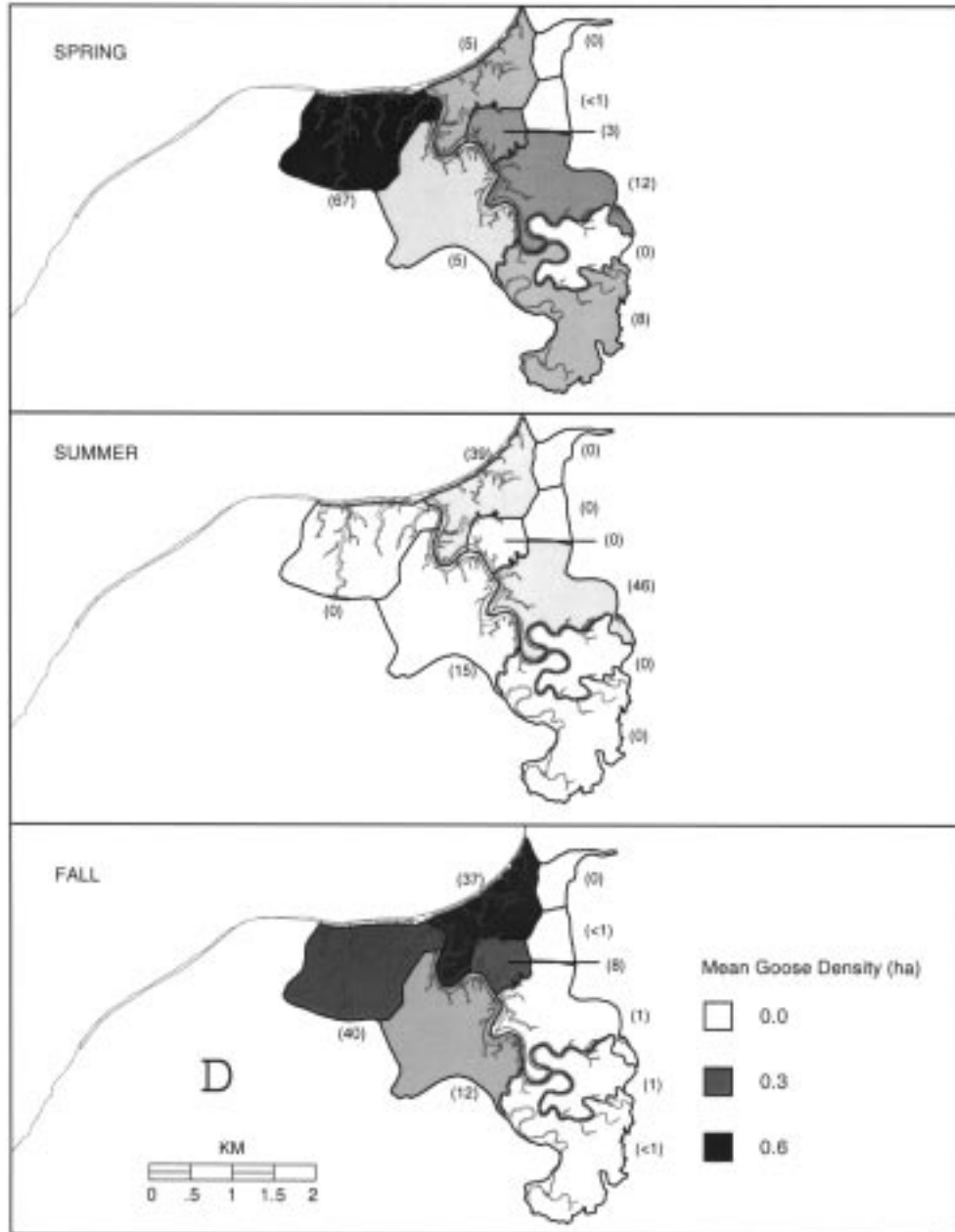

Figure II-1-4. Mean densities of geese on ERF study areas in spring, summer, and fall 2000. Numbers in parentheses are the percent of total geese observed in each area.

ing summer, 127, was lower than the 1988–1997 mean of 190. Ducks utilized Areas D, A, and B most during summer (Fig. II-1-6). The low number of surveys in 2000 may have influenced results. As in previous years, broods of American wigeon and mallards were observed in ERF during summer.

The migration phenology for ducks during the fall of 2000 was similar to years prior to 1999, with peak numbers occurring in mid-September and again in late September (Table II-1-1, Fig. II-1-2). The mean number of ducks observed in the fall, 435, was considerably lower than the 1988–1997 mean of 836 and is

the third year in a row of markedly lower fall numbers. This trend is likely related to the effects of pumping and draining on both the amount of habitat available and the food resources. Ducks utilized Areas B and D most in fall, with highest densities in Areas B, CD, and D (Fig. II-1-6). The high percentage of ducks reported for Coastal West reflects more use of permanent ponds in the far west corner this year than in previous years, rather than increased use of the tidal mudflats. Observations of ducks were also recorded by individual pond when possible. While it was not possible to separate small ponds in complex systems, the use of important, distinguishable ponds was recorded (Fig. II-1-7). The large permanent ponds of Areas B and D were important, as well as the Beaver Pond in Area CD, as in other years.

#### Changes in Fall Pond Use by Ducks

Because of the ongoing treatability studies and attempts to reduce exposure of ducks to white phosphorus, duck utilization of the standard study areas of ERF from 1997 through 2000 is compared in Table II-1-4. Utilization of Area C increased in 2000. The re-

duction in duck use of Area CD reported in 1999 continued in 2000, which may be attributed to continued and increased pumping. The use of the permanent ponds of Areas D and B remained high, perhaps reflecting the lack of habitat or food resources in the treated areas.

#### Bald Eagles

Numbers of bald eagles (*Haliaeetus leucocephalus*) were low in 2000 (Table II-1-1), similar to recent years. While specific shoreline surveys for eagles were not conducted, concentrations similar to earlier years of 50 or more eagles would have been noticed. Lower numbers of eagles in recent years may be due to decreased mortality of waterbirds on ERF.

#### Shorebirds

Numbers of shorebirds were combined for all species, because individual species were not identified from the airplane (Table II-1-1). Numbers of shorebirds were lower than in other recent years. Common species on ERF include least sandpipers (*Calidris minutilla*), semi-palmated sandpipers (*C. pusilla*), west-

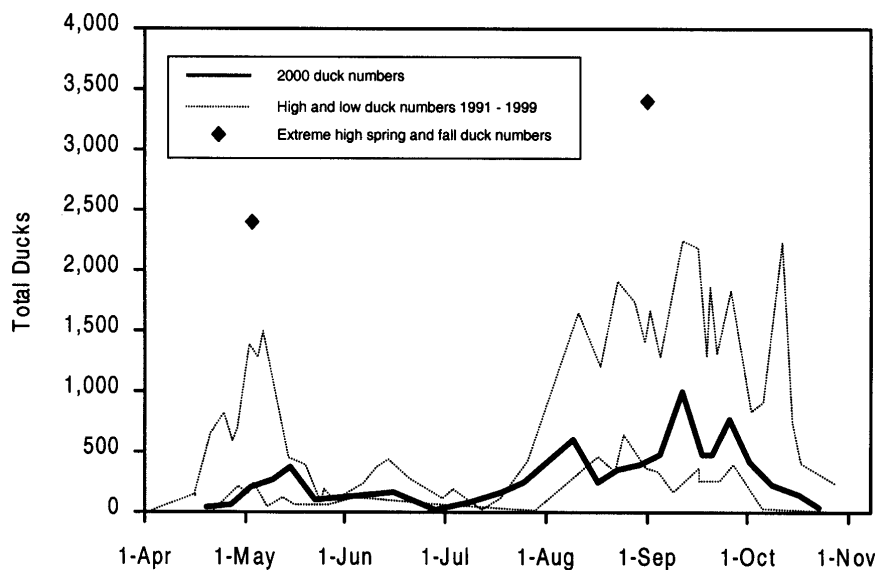

Figure II-1-5. Numbers of ducks observed during aerial surveys of ERF in 2000, compared to the low and high numbers of ducks observed from 1991 through 1999. Points indicate extreme highs in spring and fall that did not follow the general trend of duck numbers over time.

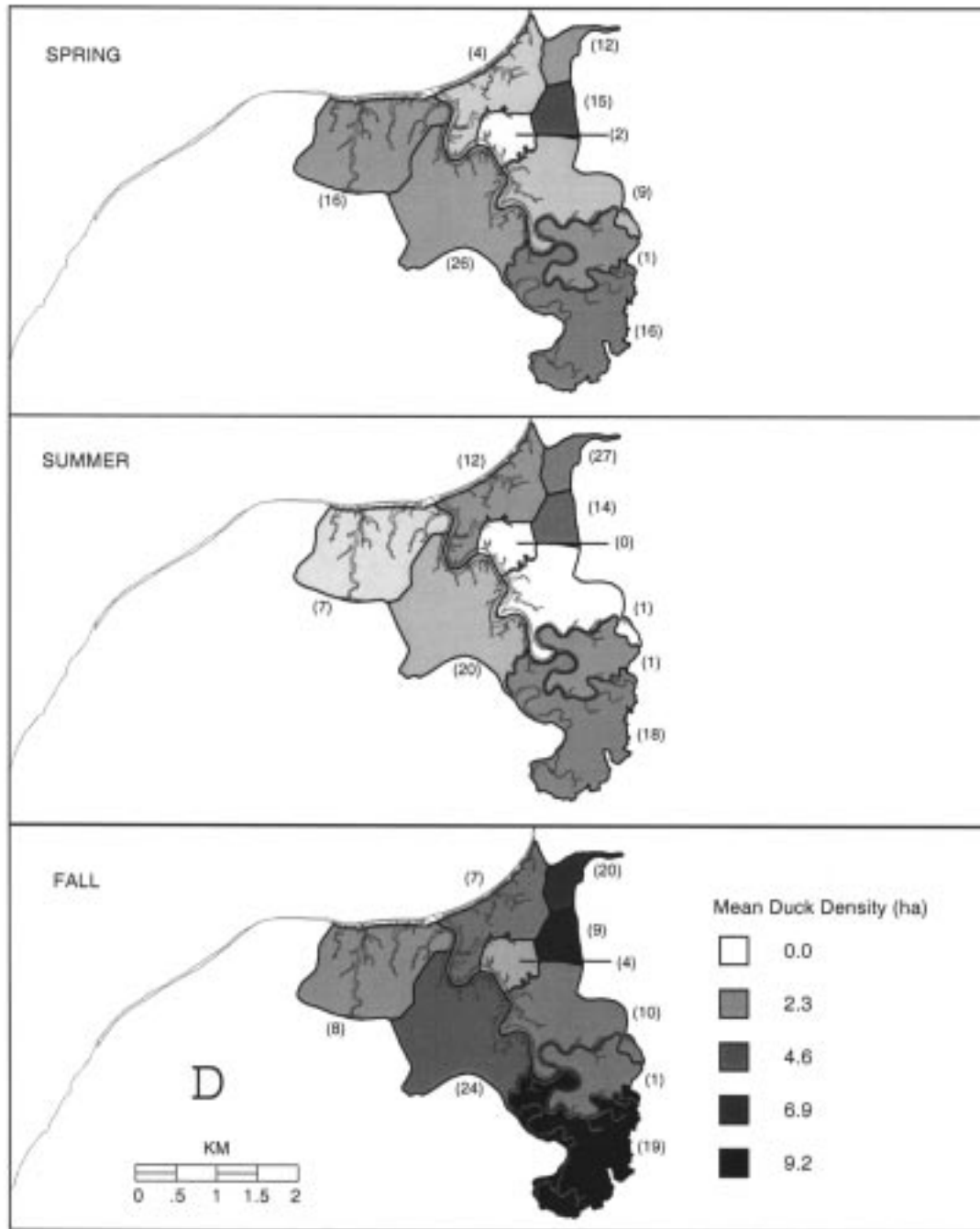

Figure II-1-6. Mean densities of ducks on ERF study areas in spring, summer, and fall 2000. Numbers in parentheses are the percent of total ducks observed in each area. The area (ha) of permanent and intermittent ponds in each area was used to calculate densities.

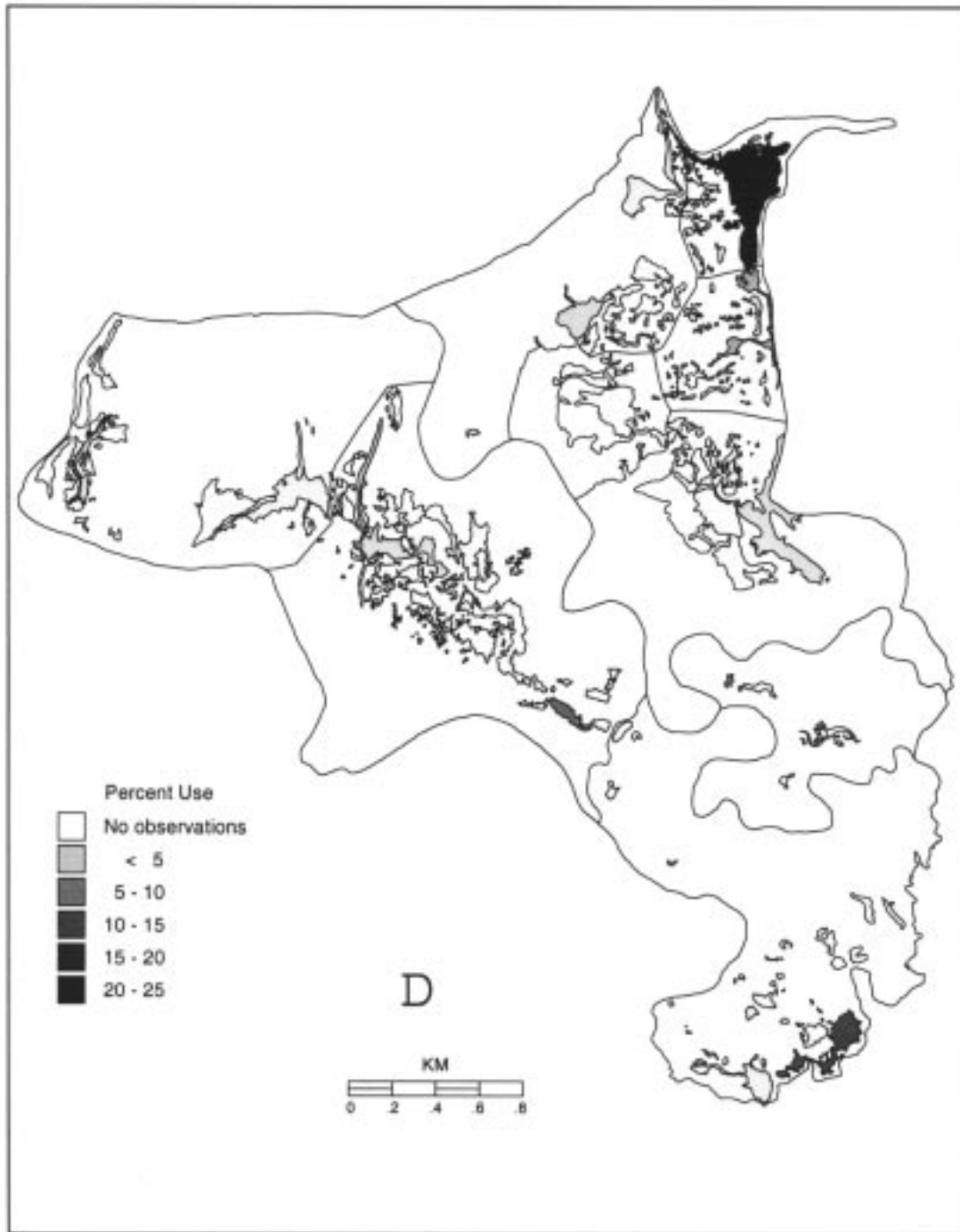

Figure II-1-7. Percent use of ponds by ducks classified to ponds during aerial surveys in fall, 2000.

**Table II-1-4. Percent use of ERF study areas and major habitat types by ducks in fall 1997– 2000. Habitat types within study areas used by  $\leq 1\%$  of ducks are not listed.**

Area/Habitat	Percent Use			
	1997	1998	1999	2000
<b>Coastal West</b>	<b>9.9</b>	<b>17.6</b>	<b>18.8</b>	<b>7.9</b>
Ponds	5.6	9.1	10.9	5.8
Knik Shoreline	4.3	7.6	6.6	1.8
<b>A</b>	<b>14.6</b>	<b>5.6</b>	<b>14.9</b>	<b>23.5</b>
Ponds	14.5	5	11.5	16.7
<b>B</b>	<b>25.0</b>	<b>19.2</b>	<b>20.1</b>	<b>19.0</b>
Ponds	19.2	18.2	16.1	17.8
Eagle River	5.8	1	1.4	1.2
<b>Racine Island</b>	<b>0.6</b>	<b>1.1</b>	<b>1.5</b>	<b>0.7</b>
<b>C</b>	<b>17.9</b>	<b>4.8</b>	<b>4.8</b>	<b>10.0</b>
Ponds	2.4	4.7	1.0	4.6
Eagle River	15.5	0.1	1.0	4.8
<b>CD</b>	<b>11.4</b>	<b>15.3</b>	<b>8.5</b>	<b>9</b>
Ponds	11.4	15.3	3.7	5.7
<b>Bread Truck</b>	<b>1.3</b>	<b>1.9</b>	<b>2.3</b>	<b>3.7</b>
Ponds	1.3	1.9	1.1	1.5
<b>Coastal East</b>	<b>9.1</b>	<b>21.1</b>	<b>9.1</b>	<b>6.6</b>
Ponds	2.8	9.3	5.0	4.5
Knik Shoreline	6.3	11.7	0.9	1.4
<b>D</b>	<b>10.7</b>	<b>13.4</b>	<b>20.0</b>	<b>19.7</b>
Ponds	10.7	13.4	13.3	19.6

ern sandpiper (*C. mauri*), dowitchers (*Limnodromus* spp.), and greater and lesser yellowlegs (*Tringa* spp.).

#### *Gulls and Terns*

Gull species were combined for aerial surveys (Table II-1-1). They include mew gulls (*Larus canus*), glaucous-winged gulls (*L. glaucescens*), and herring gulls (*L. argentatus*). Arctic terns (*Sterna paradisaea*) were common into July. The mew gull colony, formerly in Area D, now consists of just a few pairs.

#### *Sandhill Cranes*

Sandhill cranes (*Grus canadensis*) were observed on ERF in small numbers sporadically

from spring to mid-September (Table II-1-1). No breeding sandhill cranes were observed on ERF in 2000.

#### REFERENCES

**Racine, C.H., and D.W. Cate (Ed.)** (1996) Interagency expanded site investigation: Evaluation of white phosphorus contamination and potential treatability at Eagle River Flats, Alaska. FY 95 Final Report. U.S. Army Cold Regions Research and Engineering Laboratory. Contract Report to U.S. Army, Alaska, Directorate of Public Works, Ft. Richardson, Eagle River, Alaska.



---

## **III-1. EAGLE RIVER FLATS POND PUMPING REMEDICATION PROJECT: SECOND-YEAR DEPLOYMENT UNDER THE RECORD OF DECISION**

**Michael R. Walsh and Charles M. Collins**

U.S. Army Cold Regions Research and Engineering Laboratory

### **INTRODUCTION**

This year marks the second season of remediation of the white phosphorus contamination at Eagle River Flats on Fort Richardson, Alaska. As in 1999, the frequency of high flooding tides over the course of the summer was not favorable for attenuation of the contaminant. Deployment this year was debated, as the effectiveness of draining the ponds and drying the bottom sediments was not anticipated as being high, and the funds required for even a partial effort would be substantial. A decision to commit to an effort this year was made for reasons of continuity, and deployment was scheduled for early May.

### **DEPLOYMENT**

In 2000 all six pump systems were redeployed. In Area C the pumps were deployed in the same ponds as in 1999: the 189-L/s (3000-gpm) pump in Pond 146, the 63-L/s (1000-gpm) pump in Pond 155, and the original 126-L/s (2000-gpm) system in Pond 183. In Area A, two systems were deployed again this year. Ponds 256 and 258 again had 126-L/s systems, with System 4 in Pond 256 and

System 2 in Pond 258. The larger on-board tank of the System 4 generator set (genset) allows a longer cumulative run time, important in Pond 256 because of the greater flow to that pond. The pump in Pond 258, after the initial drawdown, runs infrequently and thus does not require as much fuel over the season. System 5, the other system with a large tank, was deployed in Pond 730 in Area C/D for similar reasons. Table III-1-1 depicts the pump system locations for the 2000 field season.

An Alaska National Guard UH-60L Blackhawk helicopter was once again employed to transfer the heavy equipment from the EOD Pad to the field. In addition to the pump systems listed above, two towers and eight fuel tanks were airlifted into the field. This brings to 21 the number of lifts required for deployment. Weldin personnel did most of the rigging, and operations went smoothly after a 9-m extension was added to the sling set. The equipment transfer was accomplished in one day, with a total flight time of less than five hours. Two helicopter refuelings were required during the operation.

Three new 300-gal. double-walled fuel tanks were purchased by the Fort Richardson Directorate of Public Works for the project this



**Table III-1-1. Pump system locations for 2000 season.**

<i>Location</i>	<i>System</i>	<i>Pump capacity (Theoretical) (L/s)</i>	<i>Genset fuel capacity (L)</i>	<i>Auxiliary fuel capacity (L)</i>
183 (Area C)	1	126	940	1100*
258 (Area A)	2	126	1020	1100
146 (Area C)	3	63 / 126 / 189	1890	1890
256 (Area A)	4	126	1320	4090*
730 (Area C/D)	5	126	1320	4090
155 (Area C)	6	63	1020	1110

\*Auxiliary fuel tank for System 1 moved to Pond 256 in May. System 4 reflects this move.

season, increasing our auxiliary field fuel storage to 10,300 L (2,720 gal.) for refueling of the on-board genset tanks. Although specified to match the existing, lightweight aluminum tanks, heavier steel tanks were ordered. The resulting differential in weight is 320 kg. Although easily airlifted by the Blackhawk, these tanks, when fueled, are beyond the limits of the commercial Bell 212 and thus of limited value to the project. Nonetheless, they were deployed fully fueled in the field along with the other tanks at the beginning of the season. The tanks were distributed based on anticipated frequency of operation for the pump systems. At Pond 183, no refueling tank was positioned, as this pump runs infrequently. At Ponds 258 and 155, one filled 1100-L refueling tank was positioned at each site. At Ponds 730 and 256, one 1890-L and two 1100-L refueling tanks were positioned at each site.

The discharge line was transported with slings this season. Loads were made up from a pre-deployment load chart based on the 1999 line configurations (Appendix III-1A). A crew of five (later reduced to four) handled the loading on the EOD Pad. Five- or six-m-long slings were wrapped around the pipe choker-fashion and attached to a two-leg bridle that in turn was attached to a 12-m wire-rope extension attached to a commercial A-Star 350B2 helicopter. Loads were limited to a maximum of nine sections of 6-m pipe. Loose items, such as valves and reducers, were sling-loaded to the field with a net. A

crew of eight struggled in vain to keep up in the field. A crew of 10 would have been more effective.

The increase in efficiency of this method of deployment was substantial. Deployment time was about one hour for each system, with about 15 minutes between systems for personnel and equipment transfer to the next site. This is about half the time required for the previous method of transport through the helicopter doors. We were also able to use a much smaller and more economical helicopter for the operation. Total helicopter flight time was three hours on site. Most of the line was assembled that day (10 May), and most of the equipment was operational by 11 May, with Ponds 146, 155, and 183 drained by the end of the day. All equipment was online by 12 May, with the remaining ponds drained by 13 May. This is the earliest we have ever started remediation at the Flats.

Although no new sump locations were required this season, some additional site preparation work was carried out. This entailed blasting of drainage ditches using detonation cord and Bangalore torpedoes. Blasting was done on 15 May after the areas had been drained to increase the explosives' effectiveness. In Area C/D a ditch was blasted between the drainage to Pond 730 and Pond 75 area (Figure III-1-1). This enabled better and safer sampling in the area, where composite samples had tested positive for WP in 1999. Additional blasting with detonation cord was conducted to deepen and extend the ditches

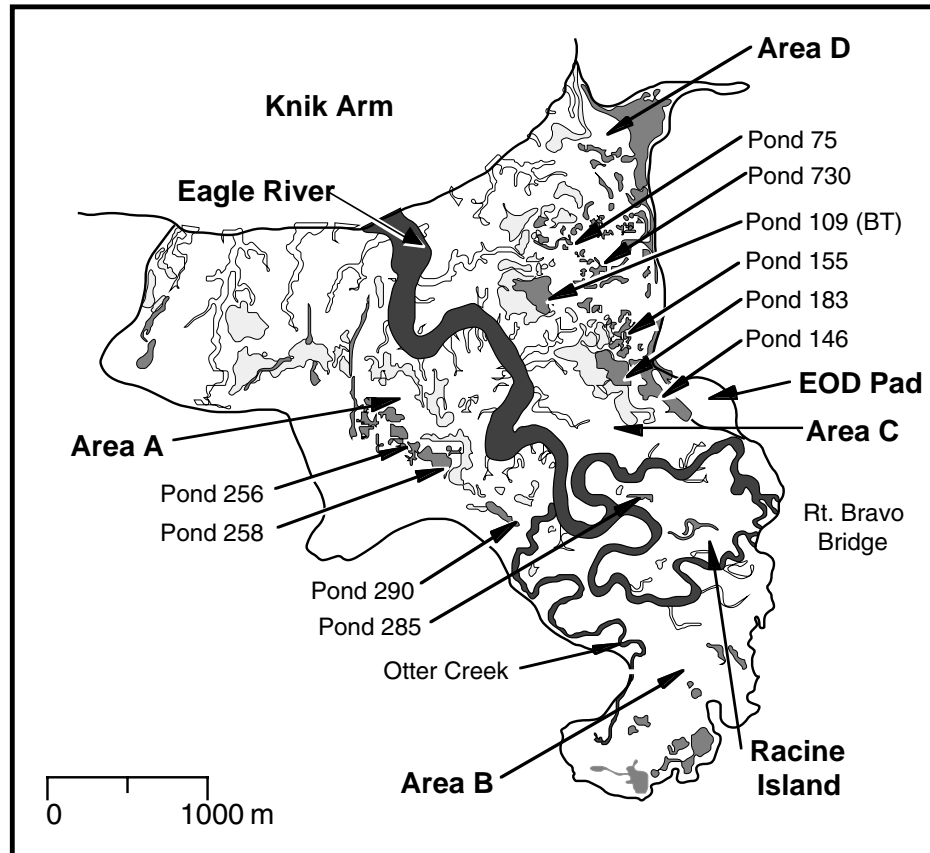

Figure III-1-1. Location of ponds at Eagle River Flats.

in Pond 258 to speed drainage of that large ponded area. Finally, a ditch was blasted around Clunie point and into the marsh in Area C to increase drainage in those areas. All this work was conducted in one afternoon.

Further work on reinforcing and extending the tide gates in B-Gully (Area C), Northern C, and Area A was carried out. Although there wasn't much of a chance of preventing any of the flooding tides this season, we hoped to squeeze an extra day or two in between flooding tides. As events played out, we were able to prevent flooding in both areas during the crucial June high-tide cycle. As a result, we had a successful remediation season.

During the first weeks of May, the meteorological station near the EOD Pad, the web cameras for Ponds 183 and 258, and the new base stations located on an abutment of the Route Bravo Bridge (Fig. III-1-2) were

installed. Data transmission over the Auto-von telephone lines from the bridge began on 11 May for the web camera, 15 May for the met station, and 20 May for the pond data acquisition sites. All data were transmitted via these lines to a server at CRREL-Hanover. The data were then displayed on the ERF web site or stored on server files. Sections III-4 and III-5 contain more information on these systems.

Operation and maintenance of the pump systems was turned over to Weldin on 15 May. On 15 and 18 May the systems were refueled so that there was a complement of full tanks at all systems to start out the season. At this time the pump controls were rewired to prevent the systems from malfunctioning when the low-water float switch becomes lodged in the down position or the high-water switch gets stuck in the up position. All units were rewired, tested, and fully operational by 17 May.

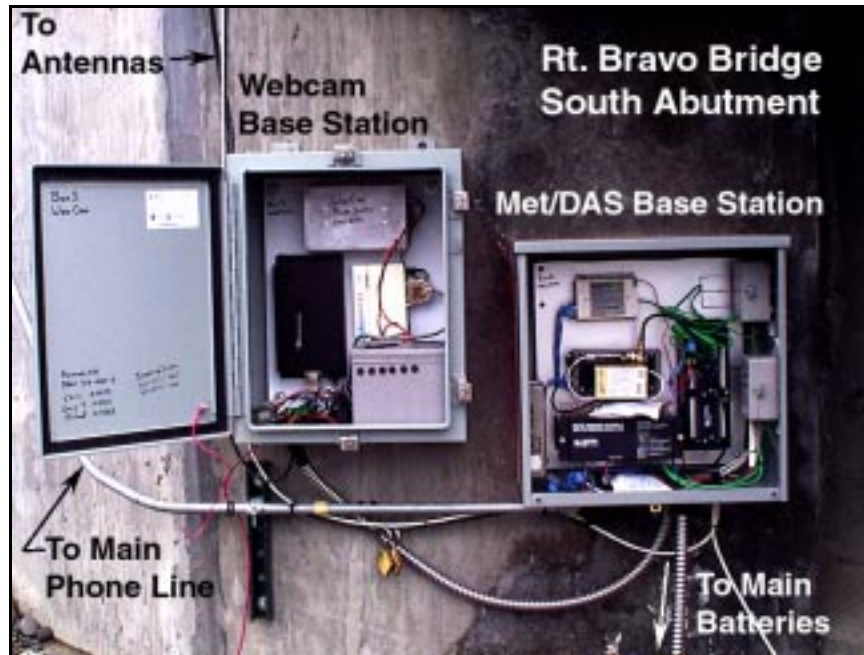

Figure III-1-2. Rt. Bravo Bridge remote monitoring base station.

**Table III-1-2. Predicted flooding tides for 2000 season (May–August).**

Date	Time	Height (m)	Time	Height (m)
May 4	834	9.63	—	—
5	910	9.82	—	—
6	949	9.82	—	—
7	1031	9.66	—	—
	—	—	—	—
June 2	802	9.63	—	—
3	845	9.82	—	—
4	930	9.85	—	—
5	1017	9.66	—	—
	—	—	—	—
July 1	739	9.57	—	—
2	828	9.78	—	—
3	918	9.85	—	—
4	1008	9.75	—	—
5	1059	9.48	—	—
30	727	9.51	—	—
31	819	9.78	—	—
	—	—	—	—
August 1	908	9.94	—	—
2	1006	9.91	1705	9.51
3	1034	9.66	2323	9.51
28	720	9.51	—	—
29	809	9.82	2100	9.51
30	856	9.97	2136	9.63
31	941	9.97	2212	9.69
September 1	1026	9.75	2249	9.63

## IMPLEMENTATION

Tidal predictions for the summer of 2000 indicated that major flooding tides would be occurring at the Flats every month of the season (Table III-1-2). We felt there would be nothing we could do about any of the tides, but we hoped to contain some of the lower tides in June, July, and August using the tide gates and wing walls installed at the heads of the major tidal gullies. With four tide gates in both Areas A and C, we felt that the effects of the flooding tides could be minimized. As tides and precipitation generally increase into September, the pullout date for the season was set for the span of 16–26 August.

Contrary to our own predictions, the tide gates were able to prevent flooding during a 9.85-m tidal event on 4 June. We therefore had a very good period of drying that occurred from general drawdown on 12 May until the start of the next flooding cycle on 2 July. At that time the summer rains began in earnest. Over the course of these 50+ days, substantial drying occurred (See Section III-2 in this document). In July the river, the winds, and the weather all cooperated to flood the Flats, and continued rain and cloudy weather prevented any more meaningful drying over the remainder of the field season. The result was a good year with respect to flooding tides, with a maximum contiguous span of 52 days. This compares quite favorably with the predicted maximum span of only 20 days. In total, from drawdown on 12 May to completion on 29 August, the Flats were drained for 93 days out of a total of 108, 50 of which were contiguous and occurred during the core drying period of 15 May to 15 September. However, a wet July and August and very high flooding tides later in the season prevented much drying after the first of July (See Section III-4 in this document).

This year marked the second year of the operation and maintenance (O&M) contract with Weldin Construction, Inc. All pump systems were checked three times a week, along with the Bravo Bridge base station and the non-automated monitoring sensors located at the instrumentation stations in the treated

ponds. Cell phone communications were employed to troubleshoot and repair faulty equipment in the field, thus greatly increasing the time all the systems were on line. The only times the systems were down were during short periods in June, July, and August when the gensets were shut down to conserve fuel in anticipation of flooding tides. The exception was dead batteries in two units, a problem quickly addressed by Weldin.

This was also the second year of helicopter support from ERA. Unlike last year, we had one pilot for the majority of the season, resulting in smoother operations. The addition of a refueling depot on the EOD Pad greatly increased helicopter utilization efficiency, thus reducing costs. ERA brought several drums of jet fuel to the EOD pad with a pickup truck. These drums were set on a CRREL-owned, plastic, four-drum spill-containment pallet next to the helicopter landing area. Use of an electric pump allowed quick refueling of the helicopter. As mentioned above, this was the first year we moved pipe using slings (Fig III-1-3), a suggestion from ERA, and it worked quite well. The pilots have also suggested several other improvements to the operation that have all paid off in increased efficiency. The only problems we are still having are the scheduling of helicopters and equipment availability. On several occasions, helicopters did not arrive or equipment was sent that was not adequate for the tasks planned for that day.

Prevention of the flooding tide in June by the tide gates resulted in less frequent refueling of the systems than planned. After the final refueling of the systems during the initial deployment phase on 18 May, aerial refueling did not occur again until 21 July. Systems in Ponds 256, 155, 258, and 730 required refueling at this time, Pond 730 due to influx from the Pond 109 ditch and Pond 256 due to infiltration from the west side of Area A. This cut in half the requirement for refueling using the commercial helicopters.

Statistics from the system monitoring readouts and O&M observations give a good indication of the active remediation process at the Flats (Table III-1-3). Systems 3, 4, and 5 all



Figure III-1-3. Retrograde of pipe to EOD Pad using slings.

ran frequently, as predicted. Cycling of System 3 was reduced significantly because of the larger sump blown the previous fall. The results of enlarging the sump in Pond 730 are not known because the genset installed there the previous year (System 2) has no cycle counter for the pump. Cycling in Ponds 256 and 730 is indicated by the high ratio of genset hours to pump hours, reflecting short pump times along with frequent warm-up and cool-down cycles for these systems. This is indica-

tive of a shallow sump, which quickly fills and is drained by the pump. Both sumps should be further deepened to reduce cycling.

**RETROGRADE**

Defueling of the systems in August was planned to minimize the on-board fuel load of the gensets. All field units except genset 6 have a maximum fuel capacity of 250 L (15-

**Table III-1-3. Pump operation statistics for 1999 season.**

System	System Start Date	System Stop Date	Total Genset Hours	Total Pump Hours	Total Pump Cycles	Pump-to-Genset Hrs Ratio	Fuel Use (Est)(L)	Est. Fuel Use Rate (L/hr)*
1	11 May	15 Aug	64	59	N/A	1.09	1290	20.2/21.9
2	11 May	16 Aug	154	126	N/A	1.22	2490	16.2/19.8
3	8 May	17 Aug	347	258	599	1.34	8610	24.8/33.4
4	11 May	16 Aug	399	272	935	1.47	5110	12.8/18.8
5	12 May	16 Aug	560	366	1747	1.53	6060	10.8/16.6
6	11 May	17 Aug	165	139	228	1.19	1890	11.5/13.6

Notes: \*Fuel consumption rates: First number based on genset hours, second rate based on pump hours. System 3 has two pumps, 63 L/H and 126 L/H. The 63-L/H pump always ran with the 126-L/H pump. The fuel use rate is based on the hours of the 126-L/H pump. Fuel use estimates are based on Weldin and CRREL data. Other data provided by Dave Mitchell and Terry Edwards of Weldin, Inc.

cm fuel depth in each tank) for retrograde due to the lift limitations of the Blackhawk. Genset 6 can carry up to 790 L (48 cm) and still be under the 4000-kg lift limit (Table III-1-4). A 12-VDC portable pump was purchased for the retrograde operation to defuel the genset tanks into the auxiliary tanks prior to airlifting the gensets. This eliminated the necessity of running the gensets without a load to burn off fuel, which is harmful to the engines. All the heavy equipment was flown out in one day, with the helicopter finished by 2:30 p.m. Rigging was done by Weldin and the AK National Guard using Guard-supplied sling equipment.

Retrograde of the discharge line occurred over the course of two days. Prior to operations the gensets were shut down (with the exception of System 3) and the pipe disconnected and piled in quantities of up to nine 6-m pieces. When available, 5- or 6-m slings were placed around the piles to prepare for airlift operations. With the pipe in place, two crews were deployed and the pipe flown back to the marshalling yard on the EOD Pad. The EOD Pad crew once again consisted of four personnel with the Bobcat loader. The field crew consisted of four personnel as well, two to direct the helicopter and attach the load and two to finish preparing the loads' missing slings. The remaining gensets that had not been defueled were defueled at this time. System 3 was left operational to prevent flooding in Area C from the inflow of the beaver channel. Once again, sling-loading the pipe

proved to be much more efficient (Fig. III-1-3). All the pipe was retrograded in one day, even though the Messerschmidt/Bokaw BO-105 helicopter was undersize and the fuel depot ran out of cached fuel late in the day. The flight time onsite for the retrograde operation was four hours.

With the cessation of pumping activities at the Flats, preparation for storage began. All the pipe is once again being stored on the EOD Pad over the winter. This year the hose and check valves are being stored under cover on the EOD Pad. The heavy equipment is stored in the yard behind Building 724, where the oil and filters were changed with the help of Weldin. The batteries have been removed and are in storage in Building 992. These will be re-installed later as a result of the decision to have Cummins Northwest, Inc., conduct an overhaul on all the gensets and replace the rear main bearing seals on gensets 2, 4, and 5. Block heaters will also be installed in all the systems.

**PERFORMANCE EVALUATION**

Once again the systems performed beyond our expectations. This year the better-than-expected results are largely due to the effectiveness of the tide gates. A slight change in the course of the river at the head of the Flats also helped, resulting in a decrease of sheet flow from that direction into Area C during normally flooding tides. Deepening the sump

**Table III-1-4. ERF helicopter performance statistics.**

<i>Equipment</i>	<i>Fuel cap. (L)</i>	<i>Burn rate (L/hr)</i>	<i>Payload: full fuel load (kg)</i>	<i>Payload: 1.5-h fuel load (kg)</i>
Bell 206L	415	125	225	415
Bokaw BO-105*	N/A	227	400	500
A-Star 350B2	540	170	710	910
Bell 212 (Huey)	830/1760†	378	375	1130
UH-60L Blackhawk	1360	564	3600	4100

Notes: \*BO-105 numbers are estimates based on performance in the field in 2000. N/A = Not available.

†Includes 930-L auxiliary onboard fuel tanks.

last fall allowed the lowering of the water level in Pond 146, exposing more of the highly contaminated sediments in the vicinity of Canoe Point and the bird tower as well as decreasing the cycling of System 3 in Pond 146 (Fig. III-1-4).

Pond 730 remains problematic. Reblasting the Pond 730 sump in 1999 probably had a much smaller effect on pump performance than in Pond 146 because of poor placement of the charges. The additional blasting done this spring drained the affected areas more efficiently and allowed us to address additional adjacent areas, such as the marsh in Area C and the Pond 75 complex in Area C/D and Coastal West. The frequent inundations from flooding tides through the Bread Truck ditch into Pond 109 and then into portions of Area C/D negate much of the drying that might otherwise occur. The lowered threshold caused by the ditch allows flooding by only moderately high tides that normally would not have flooded the area.

Installing a large "tide gate" in the Bread Truck ditch has been discussed with JoAnn Walls, Bill Gossweiler, and Terry Edwards of Weldin. The area was surveyed this August

and a location for a tide gate chosen. According to Weldin, the ditch advanced as much as 6 m in one flooding cycle this season. Pond 730 rarely escapes the monthly high tides now. Further deepening of the sump at Pond 730 should reduce the cycling of the system and the consumption of fuel, but remediation of this area will remain marginal until the Bread Truck ditch is addressed.

All areas experienced some drying. Area A dried more completely than in 1999, with cracks appearing throughout the affected pond areas. As mentioned, Pond 146, including Clunie Inlet, dried to a much larger extent than in 1999. Pond 183 was so dry during the latter part of June that the sensors topped out again. Pond 155 dried somewhat, and Pond 730 saw only marginal drying. Again, we should emphasize that although a maximum dry period of only 20 days was predicted because of flooding tides, we were able to achieve more than 50 contiguous days without widespread flooding (Fig. III-1-5). Rains starting in early July greatly reduced the effectiveness of the remediation method for the remainder of the season, but it was a very successful season all the same (Fig. III-1-6).



Figure III-1-4. Pond 146 off Canoe Point. Note the vegetation in the previously ponded area.

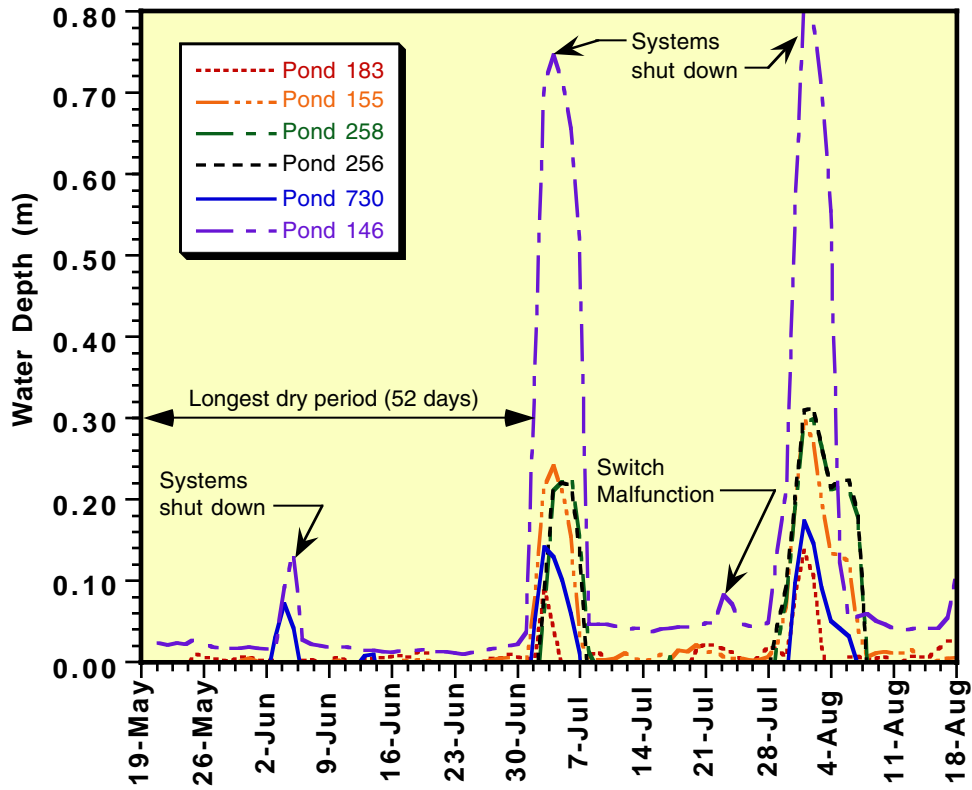

Figure III-1-5. Seasonal pond depth data for all treated ponds.

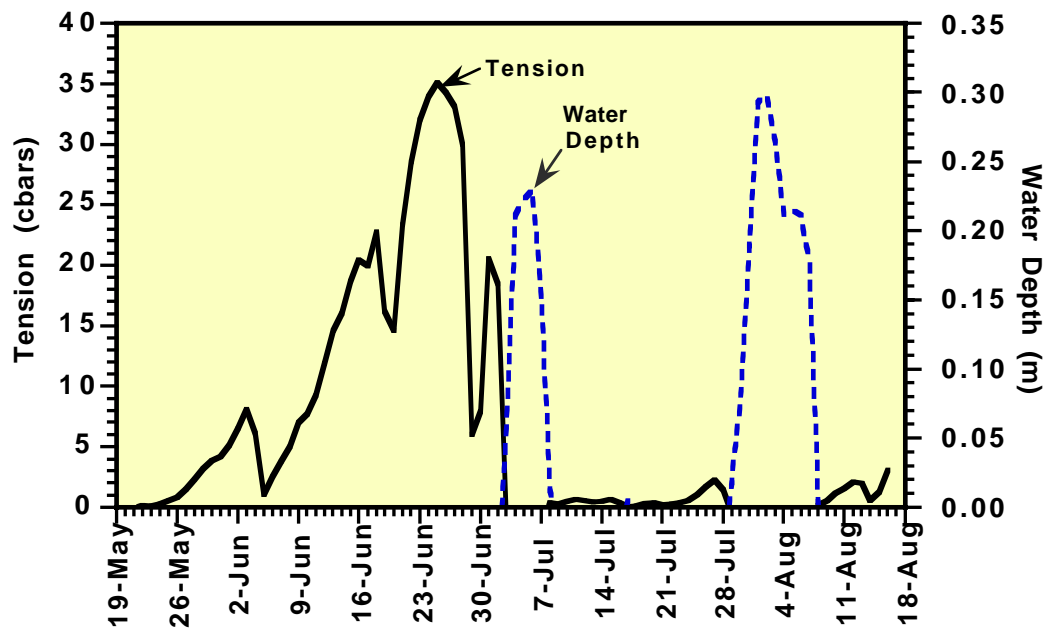

Figure III-1-6. Soil tension vs. water depth in Pond 258. Higher tension implies drier soil.



## EQUIPMENT IMPROVEMENTS

This is the fifth year of operation of the pump systems and the fourth year of actual deployment. The systems have evolved significantly since the first unit arrived in 1995 for limited testing and developmental work. Table III-1-5 lists some of the equipment modifications that were implemented in 2000. These changes have further increased the systems' reliability as well as decreased fuel consumption. We are now at the point where further modifications will result in only minor improvements in performance and reliability of the major systems.

The control logic was modified so that if the low water switch becomes lodged in the down position or the high water switch becomes lodged in the up position, the controls

default to a standby status, preventing the generator from starting or the pump from continuing to run in a dry sump. The new stand-offs that were designed to hold the switches did not hold up to the brackish water, so stainless steel ones have been designed and will be installed next season.

The three 1100-L double-walled auxiliary fuel tanks that were added this season to complement existing tanks deployed last year proved to be too heavy when fueled (1500 kg) for even the Bell 212. They are still useful as auxiliary tanks in the field but can only be moved by the Blackhawk when filled. Additional discharge line hose for System 3 was installed, adding flexibility to the configuration of the discharge line for that system as well as reducing the work required in the deployment and retrograde of the line between

**Table III-1-5. Equipment and system modifications for 2000.**

<i>Modification</i>	<i>System(s)</i>	<i>Date</i>	<i>Purpose</i>	<i>Result</i>
Extended tide gate	—	May	Prevent flooding by tides >9.5 m	Successful up to 9.85 m
Rewired controls	All systems	May	Prevent fault due to stuck low-water (down) or high-water (up) switches	Implemented and tested successfully
Replaced check valve seals	All systems	May	Decrease backflow and leakage	Partially successful
Added hose to discharge line	Sys. 3 (146)	May	More flexible configuration, easier installation and retrograde of 12" line	Successful
Used slings to move pipe.	All systems	May/Aug.	Decrease time helicopter time needed to move the pipe in and out of field	Very successful
Used shackles on load lift points	All systems	May/Aug.	Speed the attachment / detachment of loads, increase safety	Very successful
Bobcat loader on site	—	May–Aug.	Expedite moving of equipment, help with discharge line, reduce number of personnel.	Very successful
Added three 1100-L field fuel tanks	Systems 4 and 5	May	Reduce number of required Blackhawk refueling runs	Tanks too heavy; useful addition, however
New video monitoring system	Areas A and C	May	Better reliability, more coverage	Successful, but needs further development work
New communication link for met station, DAS, and webcam	Bravo Bridge	May	Lower cost of data transfer while increasing reliability, eliminate cell phone	Successful; needs a little more development work

the EOD Pad and the Eagle River near the entrance to the Pad. With the use of the slings, we were also able to airlift the pipe between the riverbank and the edge of the EOD Pad. All the check valve seals were replaced with a more robust sealing arrangement to improve their performance.

A Bobcat 753 skid-steer loader was obtained off the Corps excess equipment list for use this year. After some minor repair work by Roads and Grounds, the loader was brought to the EOD Pad. The Bobcat proved very useful in moving pipe, wire reels, equipment crates, and even empty fuel tanks. It was also critical in the deployment and retrograde of the discharge line. It is definitely a valuable addition to the project. Further repair work on the loader is being conducted this winter at the CRREL office in Fairbanks.

The Eagle River Flats web page has been completed and expanded. It is accessible through the CRREL public web site at [www.crrel.usace.army.mil/erf](http://www.crrel.usace.army.mil/erf). From this site, access to the bibliography, the web cameras, the pond data acquisition sites, and the meteorological data is currently available, as well as several other features such as points of contact, site ecology, and tide tables. A “Current Activities” button has been added to the home page that gives an update on Flats-related activities.

**THE 2001 SEASON AND BEYOND**

The 2001 season is predicted to be a very good one for remediation at the Flats. There are essentially no flooding spring tides in May and June, and the July tide may be preventable depending on climatological conditions. The first sure flooding tide does not occur until 19 August (Table III-1-6). The decision needs to be made as to whether the pumps should be pulled out in mid-August or mid-September. The gain in remediation over the 15-20 days after the August flooding tides may not be sufficient to justify the added expense in fuel, helicopter time, and operational expenses. However, keeping the areas drained for as long as possible will give us a

jump on the crucial first months of the next season, which looks to be even better than 2001.

Additional development work needs to be conducted on the remote monitoring systems associated with the pumping and remediation projects. After a successful year, the video system needs to be optimized, and the new meteorological and web camera base stations reconfigured to reduce idle-time current draw. An additional web camera may be deployed next season, probably in Bread Truck to monitor the ditch. These issues are discussed in more detail in Section III-5.

Other development work in progress includes the installation of solar-powered conditioning units on the gensets to prevent the

**Table III-1-6. Predicted flooding tides for 2001 season.**

Day	Time	Height (m)	Time	Height (m)
May				
6	0736	9.51	—	—
7	0821	9.54	—	—
8	0854	9.57	—	—
9	0927	9.48	—	—
July				
21	0834	9.57	—	—
22	0928	9.69	—	—
23	1011	9.69	—	—
24	1100	9.54	—	—
August				
19	0827	9.85	—	—
20	0911	10.03	2154	9.63
21	0958	10.07	2233	9.78
22	1046	9.85	2314	9.85
23	—	—	2357	9.66
September				
16	0721	9.63	2013	9.57
17	0811	10.00	2051	9.82
18	0857	10.18	2127	10.00
19	0943	10.15	2204	9.82
20	1029	9.91	2242	10.04
21	1116	9.48	2328	9.66

Notes: Pre-season tidal predictions.  
 ERF tidal classifications:  
 9.48- to 9.54-m tides: Minor / Preventable  
 9.55- to 9.82-m tides: Substantial / May be preventable  
 >9.82-m tides: Major / Unpreventable  
 Bold tides are likely flooding tides.

battery problems we had this season. During extended dry spells, such as occurred in May and June, the gensets do not run enough to keep the batteries charged. These units will condition the batteries to prevent buildup of sulfate on the plates and the subsequent reduction of cranking capacity. The redesign of the switch standoffs is already underway, and several small projects for optimizing the deployment of the pump systems are in the works. Probably the most pressing need at this time is the procurement of light-weight aluminum single-wall fuel transfer tanks for use in shuttling fuel from the EOD Pad to fielded systems. We need something light enough to be transported with 900 L of fuel by the ERA A-Star helicopter. A summary of proposed development work and equipment improvements is given in Appendix III-1-B.

Because of the savings realized in the reduced utilization of the commercial helicopter, some badly needed maintenance will be done on the gensets. All systems will get a general maintenance checkup, and Systems 2, 4, and 5 will have their rear main seals replaced. All units will have block heaters installed and will be run at least once a month to ensure that the bearings stay lubricated and the seals don't dry out. Power to the genset overwinter staging area is to be installed to hook up the block heaters.

The out years, 2002–2003, are predicted to be excellent remediation years, especially if the tide gates continue to work as well as they have in the past (Table III-1-7). A minimum of 67 contiguous non-flooding core days will occur during these years, primarily during the

**Table III-1-7: Predicted non-flooding periods using tide gates.**

Year	Duration (Days)	Longest Dry Spell *		Core Days†
		Starts	Ends	
2001	118	1 May	19 Aug	97
2002	130	1 May	7 Sept	115
2003	130	19 May	25 Sept	120
2004	94	1 May	2 Aug	79
2005	112	1 May	20 Aug	98
2006	102	1 May	10 Aug	87
2007	102	19 May	29 Aug	102

Notes: \*Between 1 May and 30 September. Values take into account the predicted effectiveness of the tide gates during normally flooding tides.

†Core days are between 15 May and 15 September.

earliest part of the season when conditions tend to be more favorable for remediation. If the gates work well for 9.7-m tides during those seasons, the contiguous non-flooding period will be much longer. The 2004 season is much like the 1999 season, and if the tide gates work well enough, it could turn into a very good season. Beyond the horizon, in 2005–2007, tides are almost ideal, with no flooding tides in June and minor ones in July. These predictions are based on past performance. Unusual climatic events, such as warmer-than-normal temperatures prior to flooding tides, unfavorable strong winds during flooding events, or heavy rain will adversely affect our ability to keep the Flats from flooding in the target ponds being treated. If the project is extended for any reason, the outlook is excellent in these years for further remediation.

## **APPENDIX III-1-A: LOAD CHARTS FOR 2000 HELICOPTER OPERATIONS**

The following pages depict the final load charts used during helicopter lift operations at Eagle River Flats at the start and end of the 2000 field season. These charts are critical to the smooth conduct of lift operations, when over 24 people can be involved and as many as 35 lifts occur over the course of a day. The charts reflect modifications made during the lift operations. The original charts are meant as a planning document and are open to modification in the field as conditions dictate.

Deployment of personnel is also a critical element in successful helicopter operations. Table III-1-A-1 depicts the distribution of personnel and their duties for each of the four major lift operations. Having sufficient manpower ensures minimal helicopter downtime due to personnel delays.

Deployment and retrograde of the heavy equipment were also accomplished over the course of one day. The load charts, Tables III-1-A2 and III-1-A3, describe these missions and the time frames involved. The sequence of operations during both these missions was modified to compensate for the fuel status of the helicopter. Lighter loads were moved ahead of heavier ones while the helicopter had more fuel, and heavier loads moved ahead of lighter loads when the helicopter had burned off more of its fuel. The addition of a second crew chief, who accompanied the field crew, and having the correct rigging expedited operations in August.

There is only one load chart for the discharge line, shown in Table III-1-A4. Deployment of the pipe required that loads be made up on the EOD Pad and sent to the field crew. On the retrograde the loads were made up in the field the day before, and the helicopter simply transported each load in turn back to the EOD Pad. We worked in a clockwise direction from Pond 258 to Pond 146. The pipe that was at the discharge end of System 3 that was over the bank between the EOD Pad and Eagle River was airlifted out. This was much easier, safer, and faster than walking it out as we have in the past. Both the deployment and retrograde of the discharge line were completed in one day, albeit a very strenuous one.

No loading charts were drawn up for refueling operations because of the unknown status of the fuel situation prior to the operation. A dedicated refueling tank for these operations is planned for next season, and a procedure will be established utilizing it.

**Table III-1-A1. Personnel deployment during major lift operations.**

<i>Operation</i>	<i>Number of personnel</i>	<i>Location</i>	<i>Tasks</i>
Deployment of heavy equipment	1	EOD Pad	Coordinate loading
	1	EOD Pad	Helicopter guide
	2	EOD Pad	Riggers
	1	Field	Field coordinator/guide
	1	Field	Safety Officer
	2	Field	Riggers
	1	Helicopter	Aerial coordinator
Deployment of discharge line	1	EOD Pad	Coordinate loading
	1	EOD Pad	Loader operator
	2	EOD Pad	Riggers
	1	Field	Helicopter guide
	1	Field	Safety officer/Clamps
	2	Field	Clamp assemblers
Retrograde of discharge line	1	EOD Pad	Coordinate activities
	1	EOD Pad	Loader operator
	2	EOD Pad	Riggers
	1	Field	Helicopter guide/rigger
	1	Field	Safety officer/Clamps
	1	Field	Rigger
Retrograde of heavy equipment	1	EOD Pad	Coordinate activities/guide
	1	EOD Pad	Helicopter guide
	2	EOD Pad	Riggers
	1	Field	Field coordinator/guide
	1	Field	Safety Officer
	2	Field	Riggers
	1	Helicopter	Aerial coordinator

Note: Does not include helicopter crews. On discharge line operations, one crewmember is onboard helicopter (pilot). For heavy lift operations, the helicopter crew consists of pilot, copilot, and crew chief. A second crew chief on the ground in the field expedites operations.

**Table III-1-A2. 2000 Load chart for heavy equipment deployment (actual loads).**

<i>Time</i>	<i>Flights</i>
0945	Crew orientation flight over Flats.
	<b>Area C / Pond 146 (Riggers on site)</b>
0950	Fly out pump (5000 lb: Weights are approximate)
	<b>Area C / Pond 183 (Riggers on site)</b>
0958	Fly out pump (3000 lb)
1011	Fly out genset (8000 lb)
1023	Fly out small white fuel tank (3200 lb)
	<b>Area C / Pond 155 (Riggers walk to site)</b>
1034	Fly out pump (3000 lb)
1050	Fly out genset (8000 lb)
1100	Fly out small white fuel tank (3200 lb)
	<b>REFUELING RUN #1 - Bryant Field</b>
	<b>Area C/D / Pond 730 (Riggers walk to site)</b>
1211	Fly out pump (3000 lb)
1223	Fly out small gray fuel tank (2600 lb)
1237	Fly out large fuel tank (5700 lb)
1250	Fly out genset (8000 lb)
	Drop off rigging on EOD Pad
	Fly riggers to C-Tower site near Pond 183
	<b>Area C / C-Tower (Riggers on site)</b>
1307	Airlift tower to Area C / Drop rigging on EOD Pad
	Pick up riggers- Fly to Area A
	<b>Fly personnel to Area A / Pond 256</b>
1330	Fly out pump (3000 lb)
1340	Fly out genset (8000 lb)
	<b>REFUELING RUN #2 - Bryant Field</b>
1445	Fly out small gray fuel tank (2600 lb)
1453	Fly out large fuel tank (5700 lb)
	<b>Area A / Pond 258 (Riggers walk to site)</b>
1507	Fly out pump (3000 lb)
1518	Fly out genset (8000 lb)
1528/37	Fly out two small fuel tanks (gray and white) (3200 lb)
1528	Drop off rigging
	Fly riggers to EOD Pad
	<b>Area A / A-Tower</b>
	Fly out riggers
1548	Airlift tower to EOD Pad
1604	Fly back riggers / End of mission.

Notes: Only one rigger available all day. Weldin did remainder (T. Edwards, D. Mitchell, C. Butters). Did not have two sets of correct rigging. Made up one out of two incorrect sets. Flight time was about 4 hours.

**Table III-1-A3. 2000 load chart for heavy equipment retro-grade (actual loads).**

<i>Time</i>	<i>Flights</i>
0920	Orientation flight over Flats
	<b>Fly personnel to Area A / Pond 256</b>
0930	Drop off riggers in Area A / Return to EOD Pad for rigging. Fly out small fuel tank (2600 lb: Weights are maximums.) Fly out large fuel tank (5200 lb) Fly out pump (3000 lb) Fly out genset (8000 lb)
	<b>Area A / Pond 258 (Riggers walk to site)</b> Fly out small fuel tank (3200 lb) Fly out pump (3000 lb) Fly out genset (8000 lb)
	<b>Area A / A-Tower (Riggers walk to site)</b> Fly rigging to tower site Airlift tower to EOD Pad
1045	Return to pick up field crew.
	<b>Fly riggers to Area C/D / Pond 730</b> Fly out genset (8000 lb) Fly out large fuel tank (5200 lb)
1115	<b>REFUELING RUN #1 - Bryant Field</b>
1250	Fly out two small fuel tanks (2600 lb) Fly out pump (3000 lb)
	<b>Area C / Pond 155 (Riggers walk to site)</b> Fly out small fuel tank (3200 lb) Fly out pump (3000 lb) Fly out genset (8000 lb)
	<b>Area C / Pond 183 (Riggers walk to site)</b> Fly out pump (3000 lb) Fly out genset (8000 lb)
	<b>Area C / C-Tower (Riggers walk to site)</b> Fly rigging to tower site Airlift tower to EOD Pad
1415	<b>REFUELING RUN #2 - Bryant Field</b>
	<b>Area C / Pond 146 (Riggers walk to site)</b>
1440	Fly out pump (5500 lb)
1447	End of mission.

Notes: Two guard pathfinders on EOD Pad all day (Coonrod and Beauvais).  
Weldin (T. Edwards) and Guard crew chief rigged in field.  
Two sets of correct slings brought to Flats. Only one used during the lift operations.  
Total flight time at Flats: 3 hr 27 min.

**Table III-1-A4. 2000 load chart for discharge line deployment (actual loads).**

<i>Load #</i>	<i>Pond 256</i>	<i>Pond 258</i>	<i>Pond 730</i>	<i>Pond 155</i>	<i>Pond 183</i>	<i>Load #</i>
1 (Sling)	Check Valve 1 x 8" x 25' Hose 1 x 10" x 10' Hose 8" (F) to 10" Adap.	8" Line: 1 x 25' Hose Check Valve	8" Line: 1 x 25' Hose Check Valve 8" (F) to 10" Adap.	8" Line: 1 x 25' Hose Check Valve	8" Line: 1 x 25' Hose Check Valve	1 (Sling)
2	8" Line: 8 x 20' Pipe 1 x 5' Pipe	4 x 20' Pipe	6 x 20' Pipe 1 x 10' Pipe	5 x 20' Pipe	8 x 20' Pipe	2
3	8 x 20' Pipe	9 x 20' Pipe	10" Line: 3 x 20' Pipe 1 x 10' Pipe	9 x 20' Pipe 1 x 10' Hose	8 x 20' Pipe 1 x 5' Pipe	3
4	10" Line: 9 x 20' Pipe 1 x 10' Pipe	9 x 20' Pipe	9 x 20' Pipe	9 x 20' Pipe	9 x 20' Pipe	4
5	9 x 20' Pipe	9 x 20' Pipe	9 x 20' Pipe	9 x 20' Pipe	9 x 20' Pipe	5
6	9 x 20' Pipe	9 x 20' Pipe	9 x 20' Pipe	9 x 20' Pipe	9 x 20' Pipe	6
7	9 x 20' Pipe	2 x 20' Pipe	6 x 20' Pipe 8" Line: 1 x 20' Pipe	8 x 20' Pipe 1 x 12.5' Hose 1 x 10' Pipe	7 x 20' Pipe 2 x 20' Hose 1 x 10' Pipe	7
8	9 x 20' Pipe		10" (F) to 8" Red. 1 x 12.5' Hose 1 x 5' Pipe (Sling Load)			8
9 (Sling)	8" Line: 1 x 5' Pipe 10" (F) to 8" Red.					9
<i>Total</i>	1300'	877'	937'	1050'	1092'	(5256')



### APPENDIX III-1-B: RECOMMENDATIONS AND STATUS OF DEVELOPMENT WORK AND EQUIPMENT MODIFICATIONS FOR EAGLE RIVER FLATS REMEDIATION PROJECT

Continual refinement of the equipment and procedures at Eagle River Flats is one of the dividends of having so many talented people involved. Over the last couple of years, the major impediments to efficient and reliable operation of the pump systems have been addressed and resolved. We are at the point where low-cost refinements to the equipment and optimization of the operational logistics will improve the overall system the greatest. Following the completion of the 2000 season operations, a meeting was held at CRREL to discuss possible improvements for the upcoming year. The following table describes these proposals and their current status.

**Table III-1-B1. Proposed equipment modifications and development work for 2001.**

<i>Description</i>	<i>Class*</i>	<i>Proposed Solution</i>	<i>Status</i>
Attaching hose to pump	D	Better marking of center of sump, marking the location of discharge end of first section of hose, and matching hose to pump	Field mod
Control cable deployment	D	Make small reel cradles to hold reel vertical; need one for each genset	On hold
Float switch extensions connectors leak	E	Order switches with longer pigtails to eliminate the need of an extension cable	Ordered
Power pigtails on pumps need tieoffs	E	Hardware ordered to enable quickly tying off the pump power pigtails for transport	Ordered
Securing loose equipment on gensets	L	Make up boxes that can be tied down to gensets that will hold or store equipment	On hold
Discharge line orientation	D	Mark and flag bell end of one section of line prior to airlift; attach rope to control load	Field mod
Use of Guard chain slings on heavy equipment	D	Attach swivel snap hooks to chain to expedite attachment operation during lifts	Ordered
Hose storage on EOD Pad	L	Construction of a 40' by 8' lean-to on the EOD Pad	On hold
Ground-to-air coordination during lifts	D	Better marking of landing spot, better planning, and better visibility of guides	In process
Missing connectors on control cables	E	Order new connectors and repair them next season	On hold
Shielding controls from sun	E	Add velcro-backed sun shields to visual access windows on control cabinets	Ordered
Mounts for webcam solar panels	E	Make flexible mounts for solar panels to optimize efficiency	Ordered
Reduce off-line power consumption of remote equipment	E	Development work is underway; components have been identified and ordered to optimize electronics	Ordered
Improve camera output	E	Looking at lenses and filters	On hold
Protection of modems at Rt. Bravo station	E	Replace commercial modems with industrial modems for added protection	Ordered

Classes: D = Deployment / Retrograde, E = Equipment mods, L = General logistics

## III-2. TREATMENT VERIFICATION: MONITORING THE REMEDIATION OF WHITE-PHOSPHORUS-CONTAMINATED SEDIMENTS IN TREATED PONDS

**Marianne E. Walsh, Charles M. Collins, and Ronald N. Bailey**  
U.S. Army Cold Regions Research and Engineering Laboratory

### INTRODUCTION

The white-phosphorus-contaminated sediments at Eagle River Flats are remediated by pumping selected ponds and allowing the sediments to dry. The 2000 season was the second year of treatment under the Record of Decision signed in September 1998, although Pond 183 in Area C was pumped in 1997 and 1998 during the development of the pumping procedure. Coinciding with the development of the treatment methodologies, we developed a variety of methods to monitor the success of the remediation. Sublimation/oxidation conditions are monitored using sensors linked to a datalogger, discrete and/or composite surface sediment samples are collected from known areas of contamination to see if the concentrations have declined with time, and residual white phosphorus from planted particles is measured to see if loss occurred.

### METHODS

#### **Composite Sampling**

*Pond 183 (Area C) and Pond 109 (BT Pond)*

In 1997 we established 200-m-long west-to-east transects in Area C and the Bread Truck

Pond (Fig. III-2-1, III-2-2) to monitor sublimation/oxidation conditions and for baseline and verification sediment sampling (M.E. Walsh et al. 1998). Three transects were established, one in Area C (Ponds 164 and 183) and two in the Bread Truck Pond (Ponds 99 and 109). Along each west-east transect at 0, 50, 100, 150, and 200 m, composite samples were collected to determine if hot spots (localized areas containing white phosphorus particles) were present. Each composite sample was made up of 92 sediment cores obtained at the nodes of a 1.82-m square grid covering a 5.46-m-wide area extending 20 m north and south of the west-east transect. For each of the three transects the highest white phosphorus concentrations were found in the middle of the ponds (samples taken at the grid 100 m along the transect). In August 2000 we again resampled these grids (C 100 m, BT South 100 m, and BT North 100 m) (Fig. III-2-3) and collected composite samples, which were made up of subsamples (31 mL, 2 cm diameter, 10 cm long) from the nodes of grids extending north and south of the transect.

*Pond 155 (Northern C)*

Pond 155 is a small, 0.35-ha (0.70-acre) permanent pond (Fig. III-2-1, III-2-3) located north of pond 183 in Area C (Pond 183), where

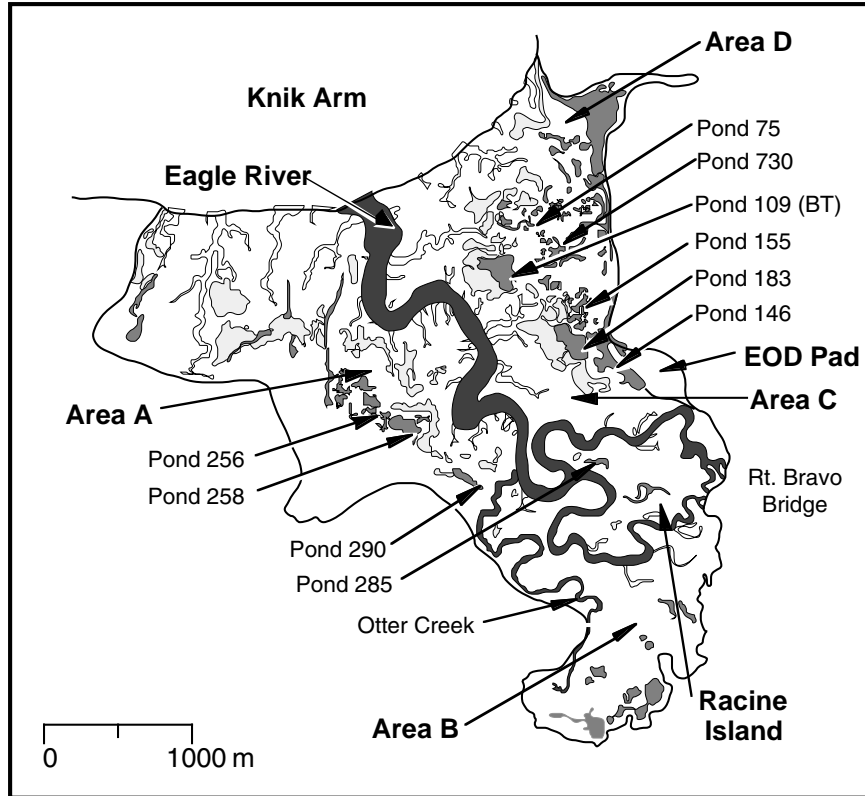

Figure III-2-1. Map of Eagle River Flats showing areas and pond identification numbers.



Figure III-2-2. Aerial oblique photo taken in June 1997 showing the main pond of Area C that was drained by pumping and the Bread Truck Pond that was drained by ditching. Transects were established across these ponds, and grid composite samples were collected perpendicular to the transect at 50-m intervals.

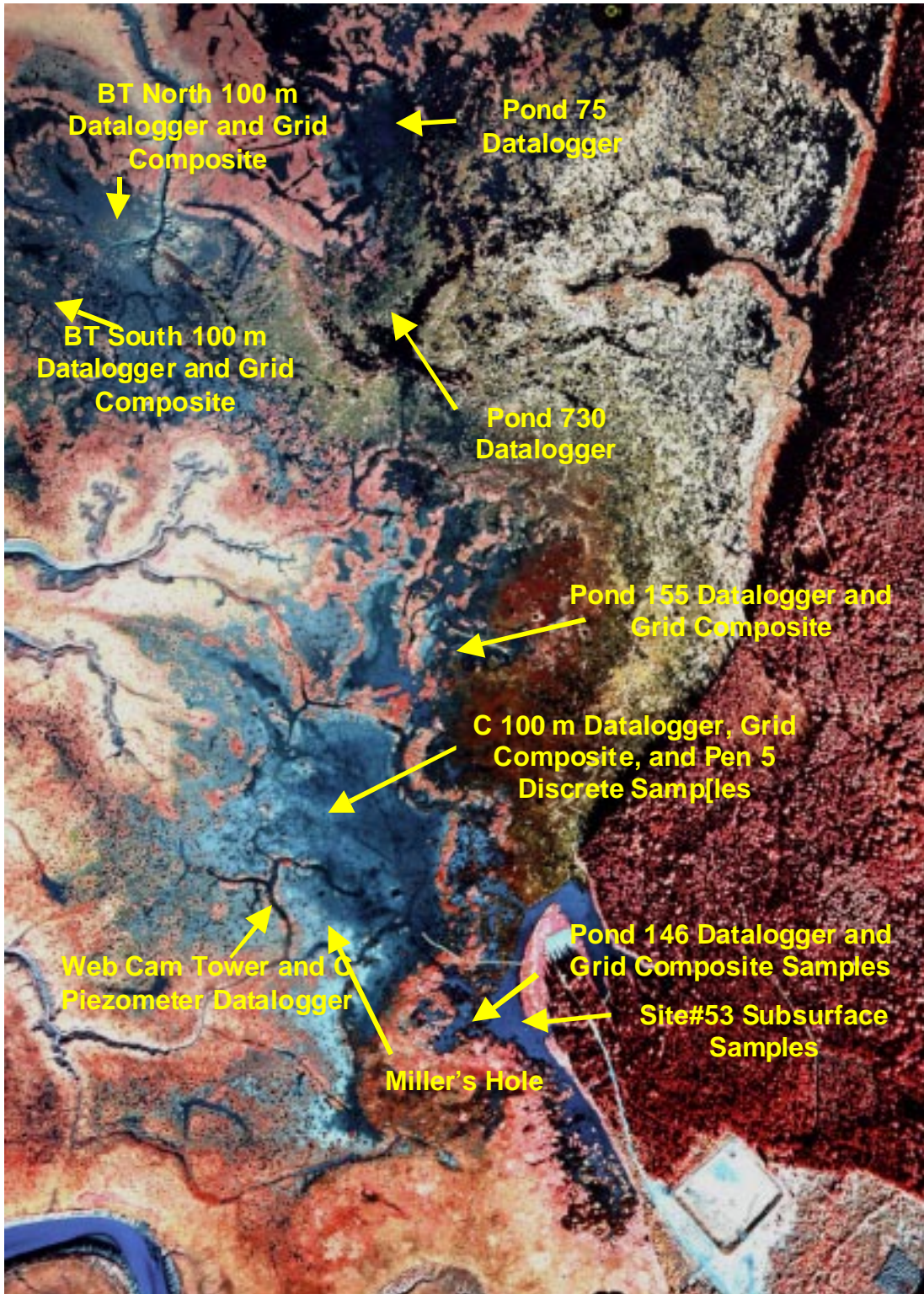

Figure III-2-3. Aerial photograph (Aeromap 8 September 2000) of the east side of ERF showing datalogger and sampling locations.

numerous waterfowl carcasses and several positive sediment samples were collected several years ago. This is the third year that this pond has been pumped. Because this pond was relatively small, the sump hole covered a significant portion of what was open water habitat. In August 1998 we collected composite samples made up of 48 subsamples from two grids covering the remainder of what will be open water habitat when the pond is not pumped. Only one of the composite samples was positive. We resampled the positive grid in June and September 1999 and in August 2000.

#### *Pond 146 (Area C)*

Pond 146 is a permanent pond (Fig. III-2-1, III-2-4) located adjacent to the EOD pad, Canoe Point, and Clunie Inlet on the east side of ERF. The pond is 5.5 ha, of which 0.45 ha was dredged in 1996-1997. Post-dredging sam-

pling located a small area of contamination remaining just off Canoe Point (Fig. III-2-4).

In 1999 we established two grids extending through and beyond the dredged area where the post-dredging sampling showed contamination (Fig. III-2-4). Composite samples from both grids showed contamination, one of which (Sample 146-2) was over 7  $\mu\text{g/g}$ . In 2000 we established two more grids, one to the north and the other to the south of the 1999 grids, and we also resampled the established grids. Each composite sample was made up of 48 subsamples.

#### *Pond 258 and 256 (Northern A)*

Ponds 258 and 256 are located on the west side of ERF in Area A (Fig. III-2-1). Pond 258 is a large pond of 1.72 ha (3.44 acres) (Fig. III-2-5) where over 50 discrete samples were collected between 1991 and 1994. Sampling was prompted by the large number of waterfowl

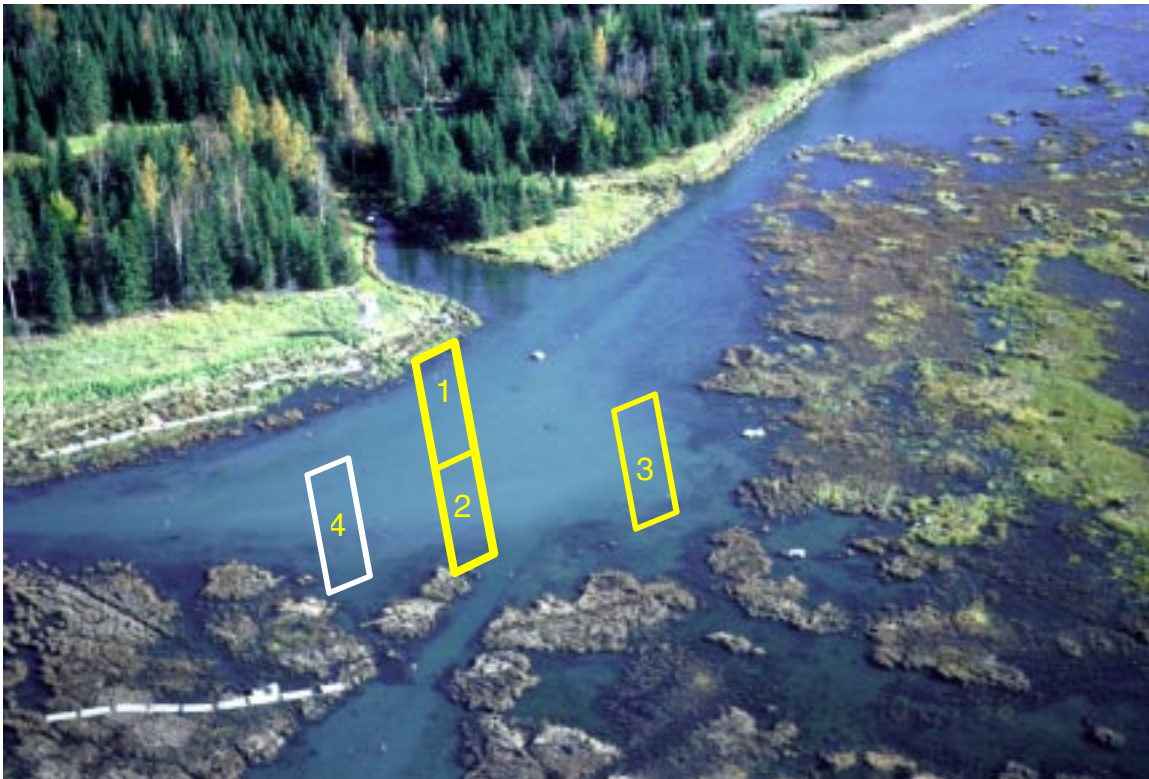

Figure III-2-4. Approximate locations of grid composite samples collected from Pond 146. The photograph was taken in 1996.

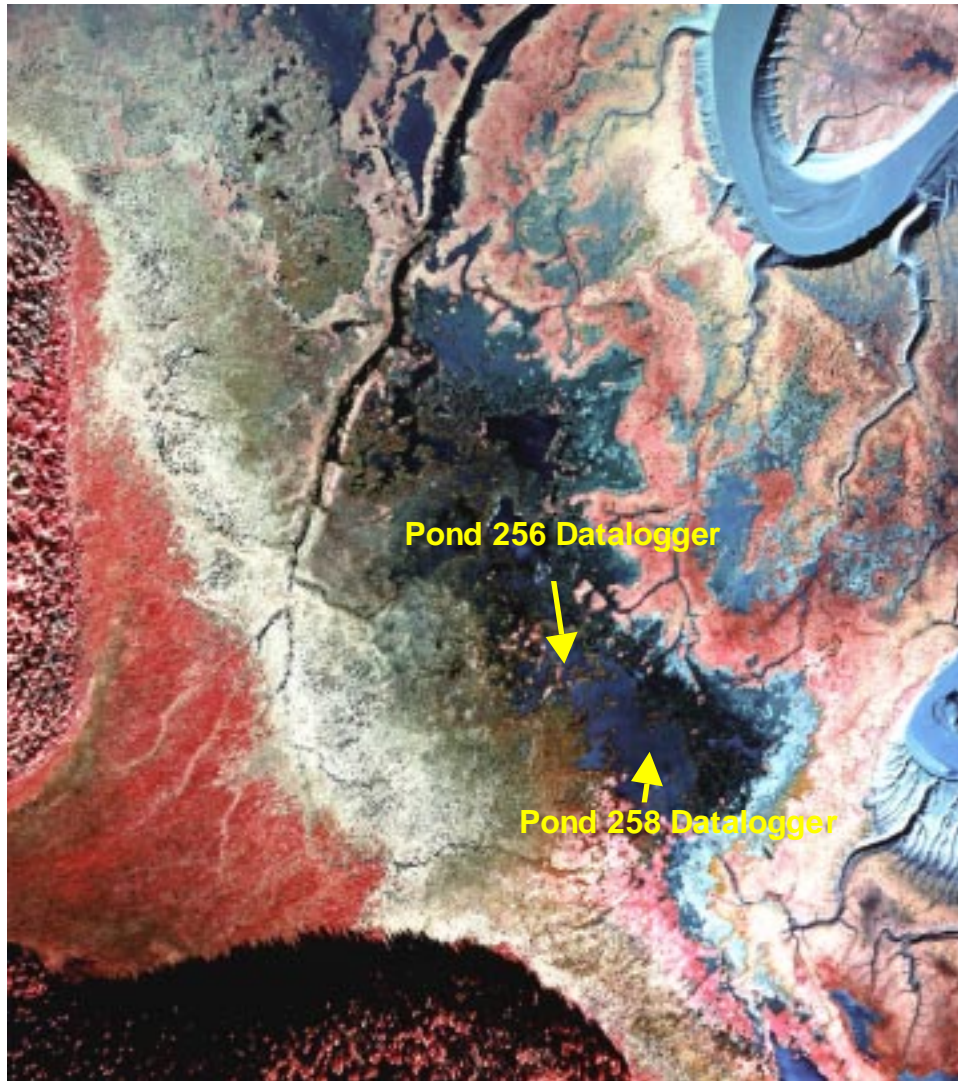

Figure III-2-5. Aerial photograph (Aeromap 8 September 2000) of the west side of ERF showing datalogger locations.

carcasses that have been found in this pond (70 carcasses in August 1992). Only four sediment samples were positive; the highest concentration found was  $0.04 \mu\text{g/g}$ . Several positive samples were collected in the marsh just north of Pond 258, but again concentrations and frequency of detection were much lower than in Area C, the BT Pond, and Racine Island.

In 1998 and 1999 we collected 46 grid composite samples and 14 composite samples along lines with a subsample collected every 2 m. Of these, one grid composite sample was positive ( $0.0013 \mu\text{g/g}$ ) and two line compos-

ites were positive ( $0.0004$  and  $0.0034 \mu\text{g/g}$ ). The samples were widely spaced, and adjacent samples were negative, indicating that this pond had some white phosphorus contamination but that its distribution was very sporadic. No samples were collected in 2000, but sublimation/oxidation conditions were monitored using dataloggers and planted particles.

*Pond 730 (Area C/D) and Pond 75 (Coastal East)*

Pond 730 in Area C/D (Fig. III-2-1, III-2-3) was treated by pumping again this year because of the mortality of radio-collared ducks

in Area C/D. Pond 75 in Coastal East, from which a positive composite sample (0.029  $\mu\text{g/g}$ ) was collected last year (M.E. Walsh et al. 2000), was drained by explosively excavating a ditch between Pond 75 and the pump in Pond 730. Sublimation/oxidation conditions were monitored using dataloggers and planted particles in both of these ponds.

#### *Pond 285 (Racine Island)*

Pond 285 was first sampled in 1993 by C.H. Racine (Fig. III-2-1). Four samples were collected, all of which contained white phosphorus (0.001 to 0.42  $\mu\text{g/g}$ ). This pond was treated in 1994 and 1995 by covering it with Aquablok. Prior to application of the Aquablok, DWRC sampled the area at 10-m intervals for a total of 29 samples, which were analyzed in duplicate at the Waterways Experiment Station, Vicksburg, MS. Of these, five samples were blank (Table III-2-1). The maximum concentration found in the positive samples was 36  $\mu\text{g/g}$ , indicating the likely presence of discrete white phosphorus particles. DWRC collected samples again in 1995, 10 months after covering with Aquablok. Fifteen samples were collected from the perimeter of the treated area. Six samples were blank, and the remaining samples ranged from 0.0017 to 0.017  $\mu\text{g/g}$ . When we visited the pond in August 2000, we found that most of the pond has transformed to bulrush marsh, with open water on the east and west sides. Small pools punctuate the marsh. We collected five grid composite samples, three from the west side and two from the east side (Fig. III-2-6). We also collected eight discrete samples from pools that were too small for a grid composite sample (less than 20 m in one dimension).

### **Discrete Surface and Subsurface Sampling**

#### *Area C*

We collected discrete surface and subsurface samples from sites that had high concentrations of white phosphorus prior to drainage of the ponds. We again intensively sampled the location of the DWRC Pen #5 in Area C (Fig. III-2-3), used from 1992 to 1993 for the evaluation of methyl anthranilate. In

1996, 1998, and 1999 we sampled a 5.46- $\times$ 20-m area including this pen, taking discrete samples at the nodes of a 1.82-m-square grid (M.E. Walsh et al. 1997). The 1998 and 1999 samplings revealed dramatic reductions in white phosphorus concentrations (Fig. III-2-7). We resampled this grid in August 2000.

In 1999 we collected eight sets of subsurface samples in Area C (seven from within pond 183 and adjacent bulrush marsh and one from pond 146) at locations that were sampled in 1992 and where white phosphorus was detectable over most of the core length (M.E. Walsh et al. 2000). We obtained the subsurface samples while the ponds were pumped dry by digging holes 30 cm deep and using a corer to take sediment samples from the wall of each hole at 0-, 5-, 10-, 15-, 20-, 25-, and 30-cm depths. White phosphorus was still detectable at only two of the eight locations. At location #615, which is within the bulrush marsh, we detected white phosphorus at sampling depths of 5 cm (0.00084  $\mu\text{g/g}$ ), 10 cm (0.003  $\mu\text{g/g}$ ), and 25 cm (0.0018  $\mu\text{g/g}$ ). At location #53, which is adjacent to the dredge channel in Pond 146, white phosphorus was detectable along the entire length of the core (Table III-2-3). In August 2000 we resampled location #53.

Two sets of subsurface samples were taken from the bottom of Miller's Hole (Fig. III-2-3), the crater produced when a white phosphorus mortar round was detonated in May 1992. At this site we used a small shovel to collect sediment at 0- to 10-cm depth and 10- to 20-cm depths.

### **Laboratory Analysis of Sediments for White Phosphorus Residues**

In the laboratory each composite sample was thoroughly mixed by stirring and kneading. To obtain an estimate of average white phosphorus concentration, a 200-g subsample was taken from each composite and analyzed using solvent extraction (100 mL iso-octane) and gas chromatography (EPA SW-846 Method 7580). If concentrations were high, the remainder of each composite was rinsed through a 30-mesh sieve (0.59-mm sieve opening) to remove the fine-grain sediment. Ma-

**Table III-2-1. Samples collected in or near Pond 285. Aquablok was applied in July 1994.**

Sample ID	Date Coll.	UTMs (m)		WP Conc. ( $\mu\text{g/g}$ )		August 2000 Samples*
		Easting	Northing	Rep. 1	Rep. 2	
CRREL 1297	24-Aug-93	355,314	6,800,474	0.017		Composite 4 (6.9 $\mu\text{g/g}$ )
CRREL 1298	24-Aug-93	355,310	6,800,484	0.0025		Composite 4 (6.9 $\mu\text{g/g}$ )
CRREL 1299	24-Aug-93	355,247	6,800,501	0.42		Discrete 7 (0.019 $\mu\text{g/g}$ )
CRREL 1300	24-Aug-93	355,214	6,800,501	0.0011		Composite 3 (0.054 $\mu\text{g/g}$ )
DWRC RI-89	21-Jun-94	355,170	6,800,515	0.023	0.010	Composite 2 (0.023 $\mu\text{g/g}$ )
DWRC RI-88	21-Jun-94	355,180	6,800,496	0.00017	0.00019	Composite 2 (0.023 $\mu\text{g/g}$ )
DWRC RI-87	21-Jun-94	355,181	6,800,509	0.031	0.097	Composite 2 (0.023 $\mu\text{g/g}$ )
DWRC RI-86	21-Jun-94	355,182	6,800,520	0.046	0.035	
DWRC RI-85	21-Jun-94	355,193	6,800,513	0.00061	0.00065	
DWRC RI-84	21-Jun-94	355,205	6,800,506	0.20	0.19	
DWRC RI-83	21-Jun-94	355,217	6,800,499	0.0022	0.0022	Composite 3 (0.054 $\mu\text{g/g}$ )
DWRC RI-82	21-Jun-94	355,228	6,800,503	0.0035	0.0053	
DWRC RI-81	21-Jun-94	355,229	6,800,492	0.037	0.025	
DWRC RI-80	21-Jun-94	355,240	6,800,506	0.56	1.37	
DWRC RI-79	21-Jun-94	355,241	6,800,495	not detected	not detected	
DWRC RI-78	21-Jun-94	355,250	6,800,489	not detected	not detected	
DWRC RI-77	21-Jun-94	355,253	6,800,499	0.00019	0.00050	
DWRC RI-76	21-Jun-94	355,254	6,800,510	0.019	0.073	
DWRC RI-73	21-Jun-94	355,264	6,800,504	16.0	0.63	
DWRC RI-74	21-Jun-94	355,265	6,800,514	not detected	not detected	
DWRC RI-75	21-Jun-94	355,266	6,800,527	0.0015	0.0026	
DWRC RI-72	21-Jun-94	355,278	6,800,508	0.076	0.043	
DWRC RI-71	21-Jun-94	355,279	6,800,520	36.2	1.70	
DWRC RI-68	21-Jun-94	355,281	6,800,490	not detected	not detected	
DWRC RI-69	21-Jun-94	355,289	6,800,501	0.00060	0.0014	
DWRC RI-70	21-Jun-94	355,290	6,800,512	0.0065	0.0084	
DWRC RI-64	21-Jun-94	355,299	6,800,483	0.0074	0.0053	
DWRC RI-66	21-Jun-94	355,300	6,800,494	not detected	not detected	
DWRC RI-67	21-Jun-94	355,302	6,800,506	0.11	0.24	Discrete 4 (0.00028 $\mu\text{g/g}$ )
DWRC RI-65	21-Jun-94	355,310	6,800,487	0.095	0.26	Composite 4 (6.9 $\mu\text{g/g}$ )
DWRC RI-62	21-Jun-94	355,311	6,800,475	0.058	0.13	Composite 4 (6.9 $\mu\text{g/g}$ )
DWRC RI-63	21-Jun-94	355,322	6,800,480	0.074	0.12	
DWRC RI-61	21-Jun-94	355,324	6,800,468	1.15	1.10	Composite 5 (0.060 $\mu\text{g/g}$ )
DWRC RI-99	25-May-95	355,190	6,800,502	0.010		Composite 1 (1.1 $\mu\text{g/g}$ )
DWRC RI-100	25-May-95	355,202	6,800,494	0.017		Composite 1 (1.1 $\mu\text{g/g}$ )
DWRC RI-98	25-May-95	355,208	6,800,507	0.0090		
DWRC RI-101	25-May-95	355,215	6,800,493	0.0095		Composite 3 (0.054 $\mu\text{g/g}$ )
DWRC RI-97	25-May-95	355,232	6,800,517	not detected		
DWRC RI-102	25-May-95	355,238	6,800,488	0.0085		
DWRC RI-96	25-May-95	355,240	6,800,512	0.0017		
DWRC RI-103	25-May-95	355,251	6,800,490	0.0090		
DWRC RI-95	25-May-95	355,267	6,800,519	0.011		
DWRC RI-94	25-May-95	355,280	6,800,518	not detected		
DWRC RI-93	25-May-95	355,292	6,800,513	not detected		
DWRC RI-92	25-May-95	355,308	6,800,512	not detected		
DWRC RI-104	25-May-95	355,308	6,800,474	not detected		Composite 4 (6.9 $\mu\text{g/g}$ )
DWRC RI-91	25-May-95	355,315	6,800,505	not detected		
DWRC RI-90	25-May-95	355,315	6,800,495	0.0040		

\*Sample points collected near or composite grids overlapping previous sample points.



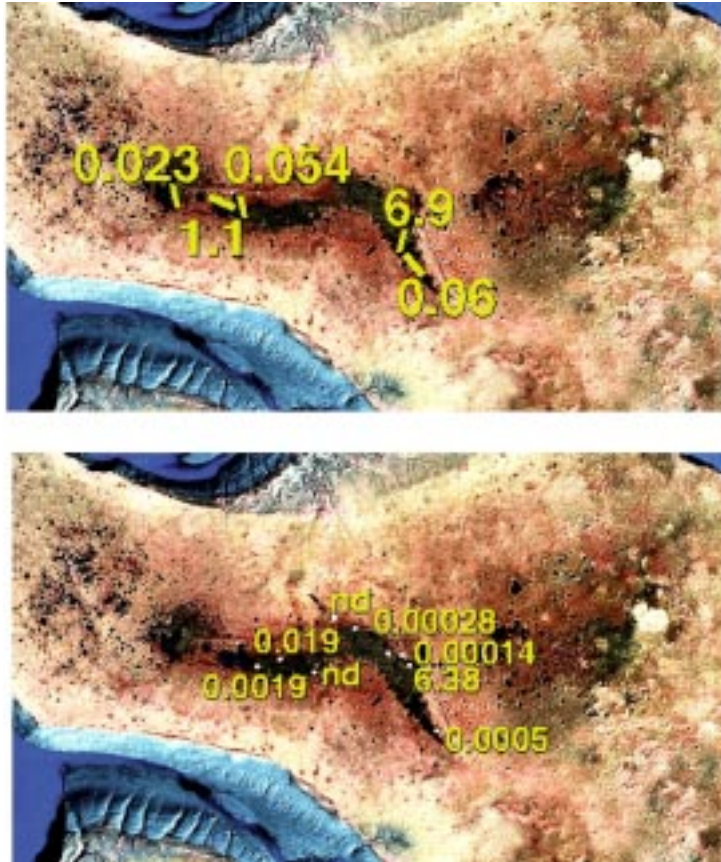

Figure III-2-6. White phosphorus concentrations ( $\mu\text{g/g}$ ) found in composite (top) and discrete (bottom) samples collected August 2000 from the Aquablok-treated pond (#285) on Racine Island (nd = not detected).

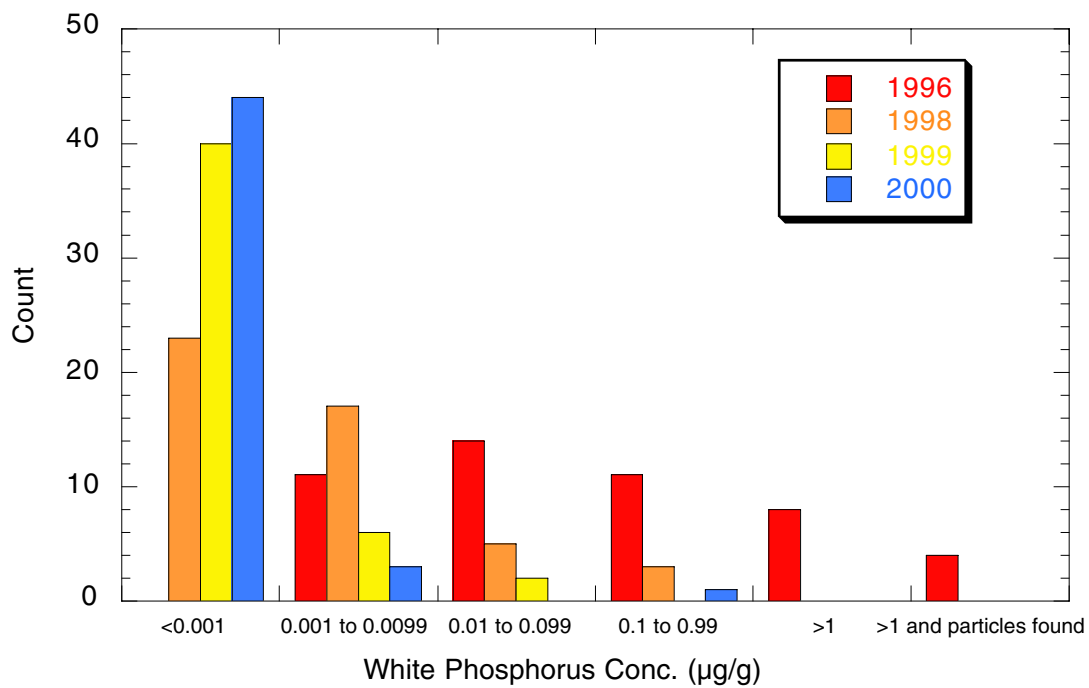

Figure III-2-7. White phosphorus concentrations found in the DWRC Pen #5. In 1996, prior to pumping, all 48 samples were greater than  $0.001 \mu\text{g/g}$ . In 2000, only four samples were greater than  $0.001 \mu\text{g/g}$ .

**Table III-2-2. White phosphorus concentrations ( $\mu\text{g/g}$ ) found on a 1.82-m-square grid in 1996, 1998, 1999, and 2000 in DWRC Pen 5.**

<i>Row</i>	<i>Column</i>	<i>1996</i>	<i>1998</i>	<i>1999</i>	<i>2000</i>
1	1	0.049	not detected	not sampled	not sampled
1	2	0.005	not detected	not sampled	not sampled
1	3	0.003	not detected	not sampled	not sampled
1	4	0.018	not detected	not sampled	not sampled
2	1	0.022	not detected	not sampled	not sampled
2	2	0.002	not detected	not sampled	not sampled
2	3	0.003	not detected	not sampled	not sampled
2	4	0.003	not detected	not sampled	not sampled
3	1	0.008	not detected	not sampled	not sampled
3	2	0.004	not detected	not sampled	not sampled
3	3	0.008	not detected	not sampled	not sampled
3	4	0.016	not detected	not sampled	not sampled
4	1	0.10	0.0006	not detected	not detected
4	2	4.30	0.0014	0.0004	0.0005
4	3	0.032	not detected	not detected	not detected
4	4	0.012	not detected	not detected	not detected
5	1	0.14	not detected	not detected	not detected
5	2	5.38	0.051	0.0006	0.35*
5	3	0.55	0.0067	0.0010	0.0004
5	4	0.010	0.0007	not detected	not detected
6	1	0.029	0.0055	not detected	not detected
6	2	0.009	0.0015	not detected	not detected
6	3	0.076	0.0042	not detected	not detected
6	4	0.008	not detected	not detected	not detected
7	1	22.9	0.0048	0.0024	0.0002
7	2	0.039	not detected	not detected	not detected
7	3	0.058	0.0007	not detected	not detected
7	4	25.3	0.0034	0.035	0.0003
8	1	8.52	0.21	0.0024	0.0012
8	2	6.01	not detected	not detected	not detected
8	3	0.015	not detected	not detected	not detected
8	4	0.76	0.0037	0.0093	not detected
9	1	0.13	0.0033	not detected	not detected
9	2	0.061	0.0010	not detected	not detected
9	3	1.73	0.089	not detected	not detected
9	4	0.063	0.0010	not detected	not detected
10	1	0.034	not detected	not detected	not detected
10	2	0.11	0.0021	0.0029	0.0005
10	3	19.7	0.19	0.036	0.0005
10	4	0.28	0.053	0.0003	not detected
11	1	421	0.0029	0.0002	0.0012
11	2	3.63	0.0024	not detected	0.0004
11	3	1.28	0.84	0.0080	0.0012
11	4	0.691	0.0074	not detected	0.0002
12	1	5.24	0.0258	0.0009	0.0005
12	2	0.62	0.0042	not detected	0.0003
12	3	0.32	0.015	not detected	0.0003
12	4	0.34	0.0035	not detected	not detected

\*WP concentrations in three other 40-g subsamples were 0.009, 0.012, and 0.029  $\mu\text{g/g}$ .

**Table III-2-3. White phosphorus concentrations found in subsurface samples collected at site #53 (Figure III-2-3) in Area C.**

Depth	White Phosphorus Conc. ( $\mu\text{g/g}$ )		
	1992	1999	2000
Surface	9.83	1.43	0.0051
5 cm	179	1.16	0.060
10 cm	0.13	0.003	0.0009
15 cm	198	0.020	0.0002
20 cm		0.116	not detected
25 cm		0.015	not detected
30 cm		0.016	not detected

terial remaining on the sieve was placed in a septa jar and equilibrated at room temperature. To determine if white phosphorus particles had been retained on the sieve, we performed headspace solid-phase microextraction (SPME) followed by gas chromatography (M.E. Walsh et al. 1995a).

Discrete samples were subsampled by taking a 40-g portion of each soil and extracting the white phosphorus with 20 mL of iso-octane. Subsurface samples, which were obtained in the field with corers, were placed directly in iso-octane. After shaking overnight, the extracts were analyzed by gas chromatography (EPA SW-846 Method 7580).

### Sublimation/Oxidation Conditions

We installed sensors and dataloggers to monitor sediment temperature and moisture conditions using the same configuration of sensors as in 1997 for most of the stations. At each station (Table III-2-4, Fig. III-2-3, III-2-5, III-2-8), sediment temperatures were monitored at 5- and 10-cm depths using Campbell Scientific (Logan, UT) Model 107B soil/water thermistor probes. Sediment moisture conditions were monitored at 5- and 10-cm depths using Campbell Scientific Model 257 (Watermark 200) soil moisture sensors. Output from both sets of sensors was taken every 10 minutes, and the hourly and 24-hour averages were recorded by a Campbell CR10 Measurement and Control Module and an SM716 Storage Module.

Tensiometers provided another measure of surface sediment moisture conditions. SoilMoisture<sup>®</sup> (SoilMoisture Equipment Corp., Santa Barbara, CA) Series 2725 tensiometers equipped with dial gauges were installed, one at 10-cm depth and another 20-cm depth at most sites, and they were read periodically by Dave Mitchell (Weldin Construction). A third tensiometer was equipped with a pressure transducer and wired to the datalogger where hourly and 24-hour averages were computed and recorded on a storage module.

**Table III-2-4. UTM coordinates and elevations of dataloggers used to record sublimation/oxidation conditions 5 June to 21 September 1999.**

Datalogger Site	E (m)	N (m)	Elevation (m)
C 100m*	355,038.50	6,801,300.50	4.64
BT N 100m	354,536.42	6,801,826.00	4.74
BT S 100m	354,521.08	6,801,724.34	4.76
Pond 155	355,112.37	6,801,536.84	4.58
Pond 146	355,303.09	6,801,168.79	4.15
Pond 730 -Station 2*	354,894.80	6,801,838.55	4.32
Pond 75	354,773.83	6,802,085.20	4.30
A Ponds - 1 (Pond 258)	353,990.20	6,800,707.95	4.61
A Ponds - 2 (Pond 256)	353,823.82	6,800,780.01	4.51
C (piezo site from '94)	355,013.18	6,801,196.88	4.78

\*Tripods were moved by ice to the east of previous locations.

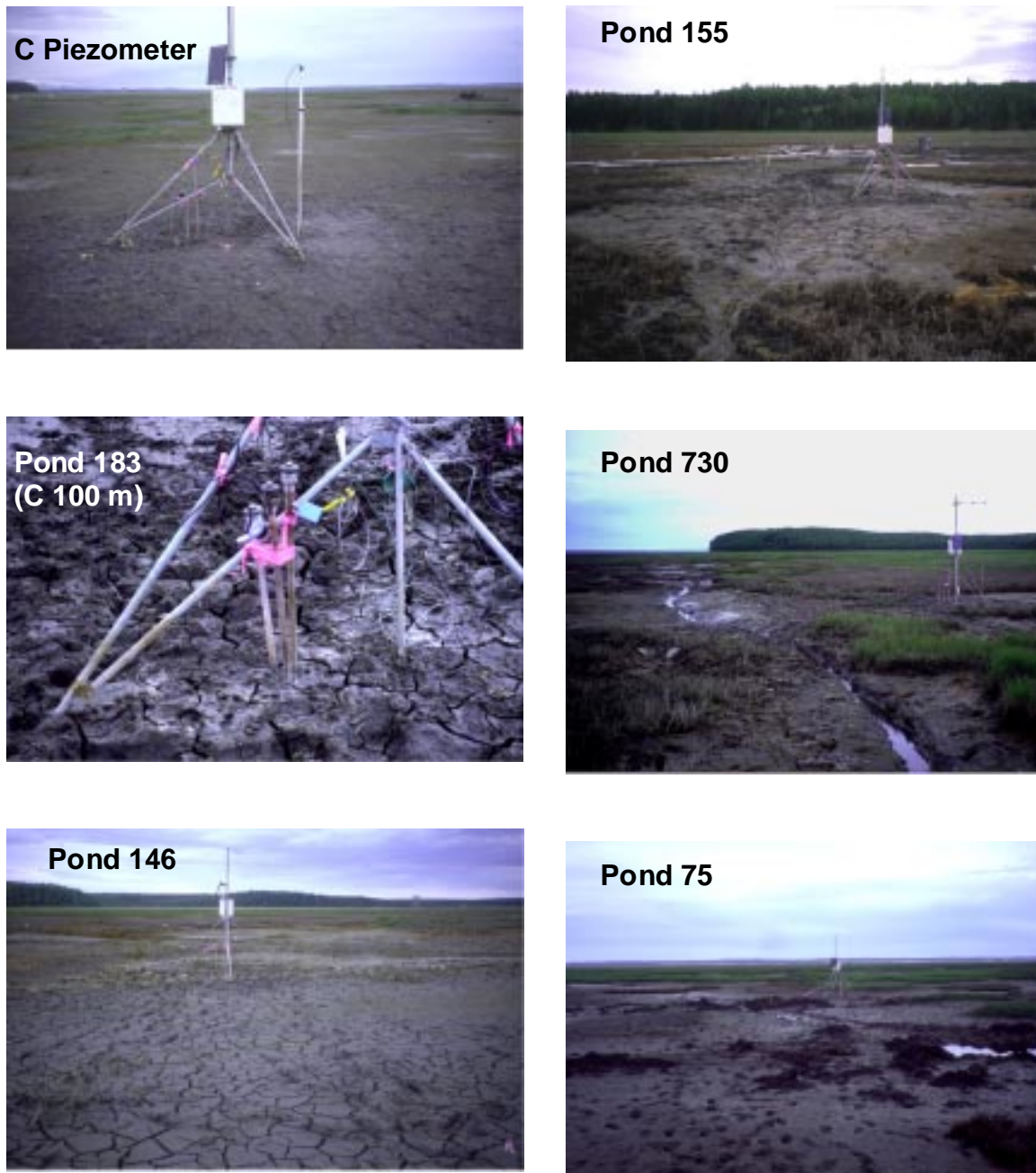

Figure III-2-8. Datalogger station photographed near peak drying conditions in June 2000.

We again monitored subsurface water levels at a shallow piezometer well that we used in 1994, 1998, and 1999 (Site 3 in M.E. Walsh et al. 1995b). A Druck pressure transducer was positioned 1.04 m below the sediment surface. We also installed Drucks to monitor the depth of any standing water in the ponds. We placed the Drucks within piezometer tubes and taped

the tubes to the mast of the tripod so that the tip of each Druck was just above the sediment surface.

On 20–24 May 2000 at each datalogger station we planted five white phosphorus particles (1.8 mm diameter, 5.6 mg) that were made in the laboratory (M.E. Walsh et al. 1995b). Each white phosphorus particle was

first inserted into a plug of saturated sediment, then the plug of sediment was placed in a nylon stocking, which was placed within the top 5 cm of saturated sediment at each monitoring station. We recovered the plugs from each station on 17–21 August 2000 to determine if the total white phosphorus mass had decreased. We also recovered plugs that were planted in June 1999. To determine if the white phosphorus particles had changed, the sediment samples containing particles were placed into isooctane to extract white phosphorus residue prior to analysis by gas chromatography.

## RESULTS AND DISCUSSION

The results of monitoring are discussed by location within ERF. White phosphorus concentrations for all composite and discrete samples are listed in Appendix Tables III-2-A1 and III-2-A2.

### *Area C (Pond 183, 146, and 164)*

Sediment temperature and moisture conditions were monitored at four sites within Area C (Fig. III-2-3, Table III-2-4). Previous work has shown that to promote sublimation/oxidation of white phosphorus particles, sediments must first be desaturated. Then sublimation/oxidation will occur, and the rate at which it occurs increases exponentially with increased temperature. Moisture sensors at the C 100 m and C piezometer sites (Fig. III-2-8, III-2-9) showed that the sediments desaturated (increased in resistance and tension above baseline) around 27 May 2000 and remained unsaturated until a flooding tide on 2 July 2000. For the rest of the summer, there were brief periods where the sediments started to desaturate, but frequent rain constantly rewetted them, and the pond reflooded in August. Sediment temperatures were lower than those observed in 1997–1999 at the C 100 m station. During the time that sediments were unsaturated, mean temperatures at 5-cm depth were 17.5, 15.8, 16.8, and 14.6°C for 1997, 1998, 1999, and 2000, respectively. Maximum 24-hour average tempera-

tures at 5-cm depth were 21.7, 18.3, 21.1, and 18.6°C for 1997, 1998, 1999, and 2000, respectively. The maximum hourly average sediment temperature (24.4°C) occurred on 24 June 2000 at 1800 hours.

Data from our piezometer data station show the relationship between groundwater elevation and tension in the surface sediments. When groundwater elevations dropped to 50 cm below the sediment surface, tension rises above 5 cbars, the estimated air entry point (Hemond and Chen 1990) for sediment in this part of ERF (M.E. Walsh et al. 1995b). The groundwater elevation dropped below the bottom of the piezometer well (1.04-m depth) on 6 June (Fig. III-2-10) and did not rise into the well again until 2 July following a flooding tide.

We recovered the remains of white phosphorus particles we planted in 1999 and 2000. In each year we planted five 5.6-mg particles for a total mass of 28 mg and we recovered a total mass of 0.099 and 12.1 mg from the 1999 and 2000 particles, respectively, so removal by sublimation/oxidation was 99.6% (for two seasons) and 56% (for the 2000 season) (Table III-2-5).

In 1997 we collected composite samples from five grids in Area C and found the highest concentrations in the sample (C 100 m) taken from the west side of Pond 183. In 1998, 1999, and 2000 we again collected replicate composite samples from this grid. White phosphorus is still detectable within this grid, but the concentration has declined from 0.07 µg/g in June 1997 to 0.00055 µg/g in August 2000 (Table III-2-6).

We installed a datalogger and resampled Pond 146, adjacent to Canoe Point in Area C, in an area that was dredged in 1996 but still had high white phosphorus concentrations in 1999 (Fig. III-2-4). Sediments started to dry at the end of May 2000 but were wetted by a flooding tide on 3 June (Fig. III-2-9). Sediments were unsaturated again by 10 June and remained unsaturated until rain on 29 June, followed by the July flooding tides. During the time that the sediments were unsaturated, the average temperature was 14.9°C. The maximum hourly temperature was 25.0°C on 24

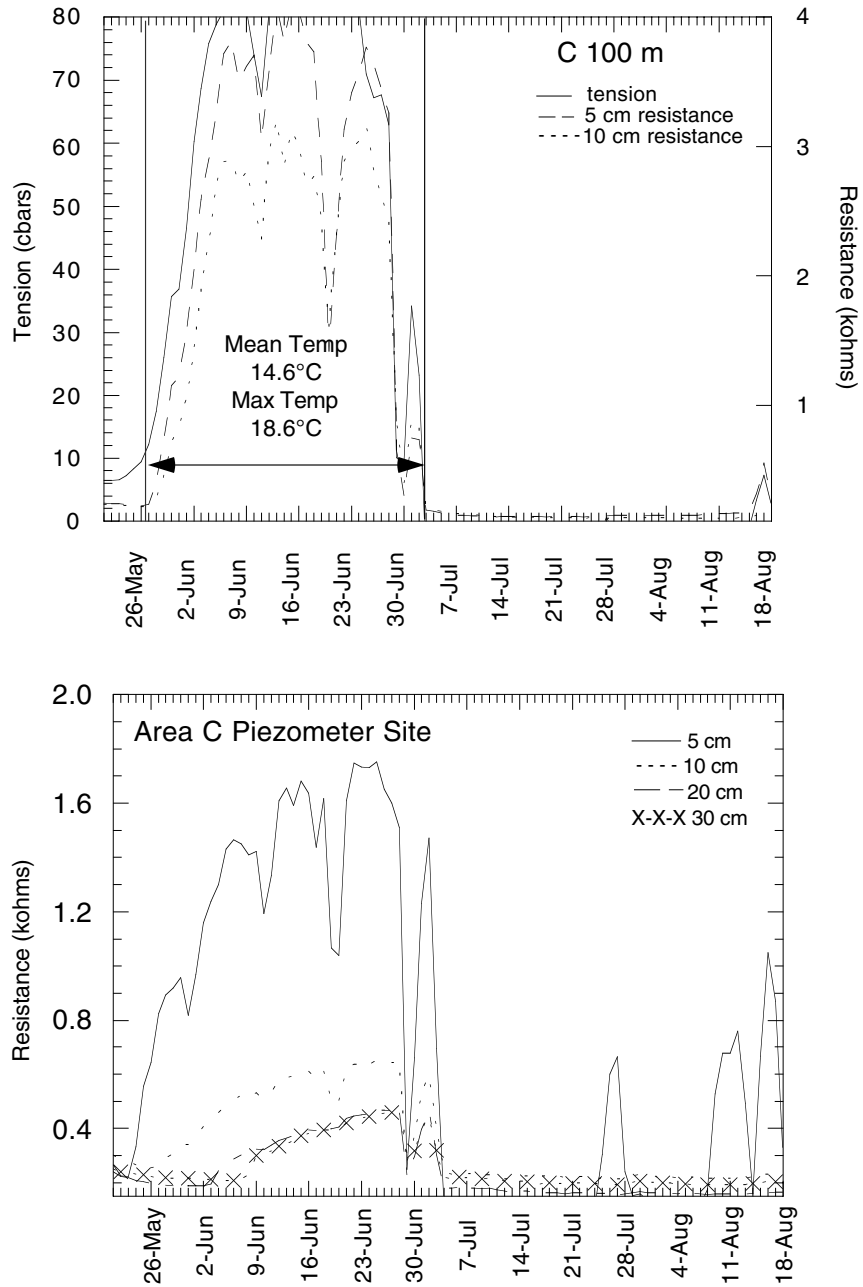

Figure III-2-9. Output from moisture sensors during the summer of 2000. Increases in resistance and tension indicate drying. Temperatures are 24-hour averages. High temperatures increase the rate of loss of white phosphorus.

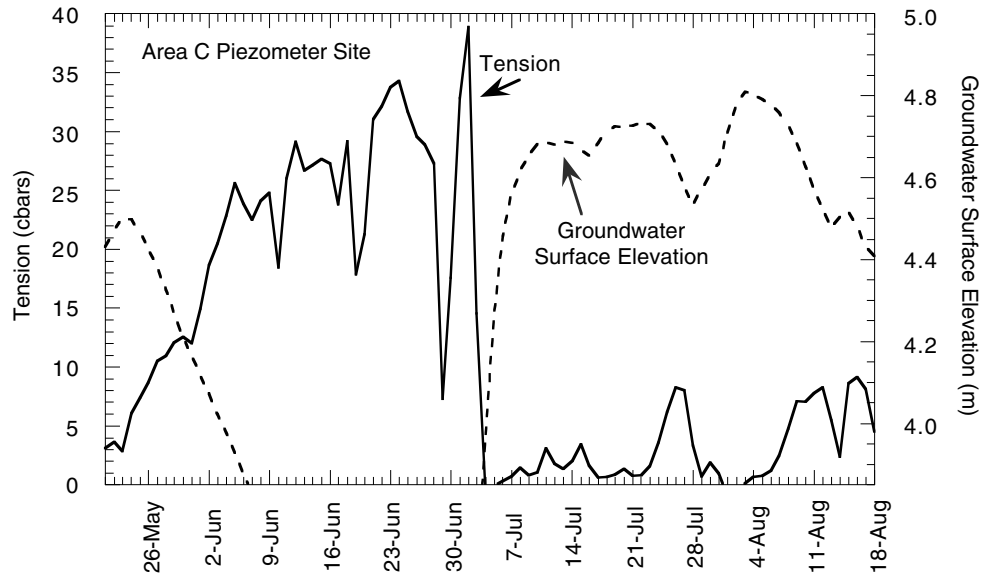

Figure III-2-10. Groundwater surface elevation in the piezometer well located in Area C and the corresponding moisture content (tension) of the surface sediment (elevation 4.77 m). A rise in tension indicates drying.

June 2000 at 1700 hours. Because of the low elevation of this station (4.15 m), the 24-hour average flooding tide heights at the datalogger in Pond 146 far exceed those at other stations, surpassing 0.8 m on 1 August 2000. Particles planted in Pond 146 declined in mass by 27%; composite samples showed a greater loss, with one sample declining from 7.31  $\mu\text{g/g}$  in June 1999 to 0.001  $\mu\text{g/g}$  in August 2000.

We have observed significant declines in white phosphorus concentrations in Pond 183 in discrete samples collected from sites where high concentrations of white phosphorus were found prior to draining. The DWRC Pen #5 (Fig. III-2-3), used in 1992 to 1993 for the evaluation of methyl anthranilate, is one such site. We intensively sampled this pen in 1996, taking discrete samples at the nodes of a 1.82-m-square grid 4 columns wide and 12 rows long. In 1996, all 48 samples contained detectable white phosphorus concentrations ranging from 0.0024 to 421  $\mu\text{g/g}$  (Table III-2-2). Over 300 white phosphorus particles were found, one of which weighed 150 mg (M.E. Walsh et al. 1997). By the fall of 2000, white phosphorus concentrations were above 0.001  $\mu\text{g/g}$  in only four samples (Fig. III-2-7).

The subsurface samples we collected also showed a decline in white phosphorus residues. At location #53, which is adjacent to the dredged channel in Pond 146, white phosphorus concentrations were almost 200  $\mu\text{g/g}$  in 1992. In 1999, white phosphorus concentrations were still high ( $>1 \mu\text{g/g}$ ) (Table III-2-3). The sump in Pond 146 was deepened in the

**Table III-2-5. Loss of white phosphorus from particles planted in the top 5 cm of drained ponds. The locations correspond to data stations in Table III-2-4.**

Datalogger Location	Loss*
C 100 m	56%
BT North 100 m	79%
BT South 100 m	32%
Pond 155	32%
Pond 146	27%
Pond 730 Station 2	10%
Pond 75	12%
Pond 258	89%
Pond 256	92%

\*Nominal initial mass was  $5.6 \pm 0.5$  mg for each of five particles yielding an initial total mass of 28 mg. Loss was computed as follows:  $1 - (\text{sum of mass remaining})/(\text{total initial mass})$ .

**Table III-2-6. White phosphorus concentrations found in composite samples collected from grids in Area C and the Bread Truck Pond.**

Date	Median White Phosphorus Concentration ( $\mu\text{g/g}$ )		
	C 100 m	BT North 100 m	BT South 100 m
4 June 1997	0.069	0.012	0.0049
4 September 1997	0.0063	0.0056	0.00087
22 August 1998	0.0074	0.0038	0.0035
15 September 1999	0.0016	0.0003	0.0045
16 August 2000	0.00055	0.0001	0.00025

fall of 1999 to enhance the drying of Pond 146. In August 2000, we again collected a series of subsurface samples at location #53. White phosphorus is no longer detectable along the length of the core. The highest concentration was  $0.06 \mu\text{g/g}$  at a 10-cm depth (Table III-2-3).

The second set of subsurface samples were from Miller's Hole, the crater produced in 1992 from the detonation of a WP UXO. Repeated sampling shows significant decreases

in concentrations in the surface sediments since the initiation of the pumping project (Table III-2-7), and in August 2000, white phosphorus was finally undetectable in the surface sediment. In 1997 we collected two narrow cores down to 20 cm from the center of the crater and found high concentrations (up to  $1730 \mu\text{g/g}$ ) in the deepest (20-cm) part of the core. This year we excavated two small holes down to a 20-cm depth. Sediment from

**Table III-2-7. White phosphorus concentrations found at Miller's Hole, a crater produced by the detonation of a WP UXO (81-mm mortar round). The crater center is 30 cm below the rim.**

Sampled	Days Since Explosion	White Phosphorus Concentration ( $\mu\text{g/g}$ )	
		Center of Crater	Rim
5/20/92	0	2,394	979
6/18/92	29	5,572	0.237
8/21/92*	93	184	0.00427
6/23/93	399	187	0.0175
8/27/93*	464	81.5	0.00177
5/16/94*	726	49.5	34.1
8/30/94	832	9.5	not detected
6/1/95†	1107	10,497	0.0051
9/17/95†	1215	166	0.0006
9/3/97	1932	1.6	not detected
8/25/98	2288	0.037	not detected
9/21/99	2681	0.0008	not detected
8/21/00	3015	not detected	not sampled

\*Crater under water when sampled.

†Crater under water all summer.



each hole was divided into two samples according to depth (0 to 10 cm and 10 to 20 cm). White phosphorus concentrations in the two deep samples were 0.0027 and 0.0039  $\mu\text{g/g}$ .

Considering all of the above, pumping has been very successful at decontaminating Pond 183 and Pond 146.

#### *Pond 155 (Northern C)*

Pond 155 (Fig. III-2-1, III-2-3) was drained by pumping for the third consecutive year. The sediments of this pond tend to remain wet following drainage of the surface water. Planted particles at this site (Table III-2-5) decreased by 32% this year, which is an improvement over last year, when there was no change. However, the white phosphorus concentration in the grid composite has not decreased. Drying of this pond might be enhanced by further shallow ditching to the sump and maintaining the surface of the water in the sump at a lower level. Further characterization could include a piezometer well to monitor the groundwater elevation and subsurface samples to determine the depth of contamination. This pond also receives sur-

face water from the blasted Bread Truck ditch, so a tide gate at Bread Truck would enhance the drying of Northern C.

#### *Bread Truck Pond*

The former Bread Truck Pond (Pond 109) (Fig. III-2-2, III-2-3, III-2-11) is no longer a permanent pond because of the drainage ditch blasted in April 1996 connecting an existing tidal gully with the pond (Collins et al. 1997). Since its excavation the ditch has continued to enlarge each year as headward erosion extends the ditch southward and eastward into the former pond area. In addition to the gully advancement, the surface sediment within 20 m of the ditch has eroded significantly (Fig. III-2-11). Our monitoring station on the north side of the Bread Truck Pond (BT North 100 m) is affected by this erosion.

The north side of the former pond drains readily through to the drainage ditch but is also more frequently flooded because of the lower flooding threshold of the ditch. The BT North 100 monitoring station recorded 20 flood events between 1 June and 5 August 2000 (Fig. III-2-12), while the C 100 m moni-

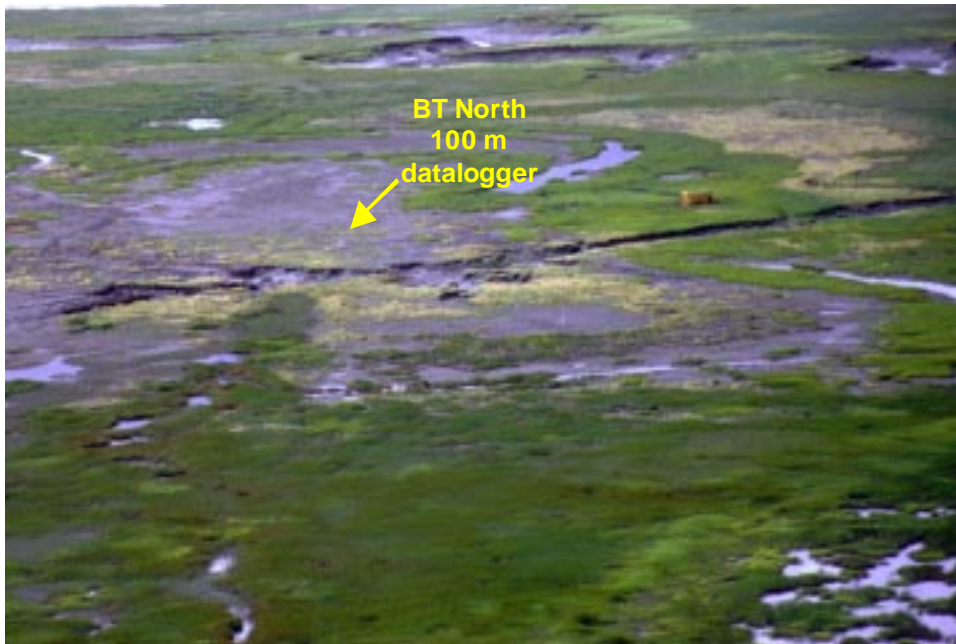

Figure III-2-11. Advancing Break Truck gully. The gully has eroded through the north side of the pond into the south side.

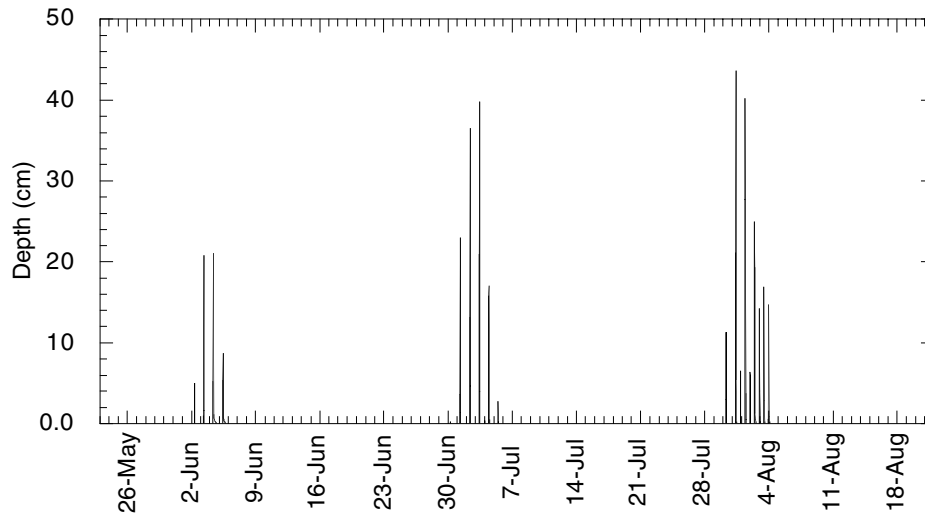

Figure III-2-12. Flood events recorded on the north side of the Bread Truck Pond.

toring station recorded only four floods. Moisture sensors (Fig. III-2-9) at the BT North 100 m monitoring station indicate that the north side of the pond dried significantly between each series of flooding tides. White phosphorus is detectable ( $0.0001 \mu\text{g/g}$ ) below the method detection limit in the BT North 100 m composite samples. Residual white phosphorus from the five particles we planted ranged from 0.08 to 2.9 mg. The total mass recovered from the five particles planted in May 2000 was 5.74 mg. Given a total initial mass of 27.8 mg, the removal was 79% (Table III-2-5). Little (0.118 mg) was left of the particles planted in June 1999 and recovered in August 2000. Removal was 99.6% for the two seasons.

The south side of the Bread Truck Pond was wetter than the north side because of poorer drainage to the ditch (Fig. III-2-9). Moisture conditions were similar to last year. The white phosphorus concentration in the composite sample taken at the BT South 100 m grid was  $0.00025 \mu\text{g/g}$ . In June 1997 the concentration range of five replicate composite samples from this grid was  $0.003\text{--}0.0079 \mu\text{g/g}$ . The 1998 and 1999 grid composites were within this range. This is the first year that a significant reduction in concentration is evident in this grid composite. The loss of the white phosphorus from the particles we planted this

year 32%. The loss from particles planted for two seasons was 99%.

Given the increased frequency of flooding and the exposure of new white phosphorus by surface erosion, the continued advancement of the Bread Truck drainage ditch should be arrested by installation of a tide gate. A tide gate would result in better drying of the south side of the pond and help future remediation actions in Areas C/D and Northern C.

#### *Pond 258 and 256 (Northern A)*

Moisture conditions in Pond 258 (Fig. III-2-5, III-2-9) were favorable for sublimation/oxidation, similar to last year. The hourly average sediment temperatures were always higher during daylight hours than in Area C (perhaps because of the slightly higher moisture content). The maximum hourly temperature average was  $27.13^\circ\text{C}$  on 23 June 2000 at 1900 hours. The loss from planted white phosphorus particles was 89%.

Pond 256 dried less than Pond 258, but the loss of white phosphorus from the planted particles was similar (92%).

#### *Pond 730 (Area C/D) and Pond 75 (Coastal East)*

Pond 730 again experienced frequent flooding from the Bread Truck ditch that constantly rewetted the drying sediments (Fig. III-2-9). Some drying did occur as the sediment con-

solidated and cracked (Fig. III-2-8). The loss of white phosphorus from the planted particles was 10%.

Pond 75, which is northeast of the Bread Truck Pond, contains the only positive grid composite sample we located last year in Areas C/D and Coastal East. A ditch (Fig. III-2-8) was explosively excavated to connect this pond to the sump in Pond 730. Although water from the pond was drained away, the sediments remained saturated most of the summer. Again, flooding from the Bread Truck ditch affects this pond. A tide gate in Bread Truck and a sump and pump in this region are recommended.

#### *Pond 285 (Racine Island)*

The surface sediments of Pond 285 are highly contaminated. Of the five composite samples collected in August 2000, all were positive, with white phosphorus concentrations ranging from 0.023 to 6.90  $\mu\text{g/g}$  (Fig. III-2-6). This range of concentrations is higher than we found in the Bread Truck Pond and Area C when we established transects across those ponds in 1997. Of the eight discrete samples we collected from Pond 285, six were positive and ranged in concentration from 0.00014 to 6.38  $\mu\text{g/g}$ . Given that we sampled only the soft surface sediment, as would dabbling ducks and swans, white phosphorus is readily accessible to feeding waterfowl in this pond. Further remediation is necessary.

## CONCLUSIONS

Pond pumping has been a major success in Ponds 183 and 146 of Area C and Ponds 258 and 256 in Area A. White phosphorus contamination levels in Area C have declined dramatically and may be undetectable in a few years. The present levels of white phosphorus contamination measured in Pond 183 indicate that there is little likelihood that hazardous amounts of white phosphorus particles remain. Pond 155, which is north of Pond 183, still contains white phosphorus at hazardous levels. Pond 730 in Area C/D and

Pond 75 in Coastal East were frequently flooded by tidal water from the Bread Truck ditch, compromising our remediation efforts in these areas.

The north side of the Bread Truck Pond dried because of drainage through the blasted ditch, and as a result, white phosphorus in the surface sediment has declined significantly. Continuing advancement has resulted in more efficient drainage of the south side of the Bread Truck Pond and what appears to be a decrease in white phosphorus concentrations in composite samples.

The surface sediment in the AquaBlok pond (#285) is highly contaminated, and further remediation is needed.

## REFERENCES

- Collins, C.M., M.T. Meeks, M.R. Walsh, M.E. Walsh, and R.N. Bailey** (1997) Pond draining treatability: 1996 studies. The draining of Bread Truck Pond. In *Interagency expanded site investigation: Evaluation of white phosphorus contamination and potential treatability at Eagle River Flats, Alaska*. (C.M. Collins and D. Cate, Ed.). CRREL Contract Report to US Army, Alaska, Directorate of Public Works. FY96 Final Report. p. 51-71.
- Hemond, H.F., and D.G. Chen** (1990) Air entry in salt marsh sediments. *Soil Science*, **150**(1): 459-468.
- Racine, C.H., M.E. Walsh, C.M. Collins, D. Lawson, K. Henry, L. Reitsma, B. Steele, R. Harris, and S.T. Bird** (1993) White phosphorus contamination of salt marsh sediments at Eagle River Flats, Alaska. CRREL Contract Report to the US Army Environmental Center, Aberdeen Proving Ground, MD AEC Report No. ENAEC-IR-CR-93063.
- United States Environmental Protection Agency** (1995) Method 7580: White phosphorus (P) by solvent extraction and gas chromatography. In *Test methods for evaluating solid waste, physical/chemical methods (SW-846), Update III*. Washington D.C.: U.S. EPA, Office of Solid Waste, p. 7580-1 to 7580-20.
- Walsh, M.E., and C.M. Collins** (1993) Distri-

bution of white phosphorus residues from the detonation of 81-mm mortar WP smoke rounds at an upland site. USA Cold Regions Research and Engineering Laboratory, Special Report 93-18.

**Walsh, M.E., C.R. Racine, C.M. Collins, C. Bouwkamp, and P.G. Thorne (1995a)** Simple field screening method for white phosphorus (P) in sediment. USA Cold Regions Research and Engineering Laboratory. Special Report 95-25.

**Walsh, M.E., C.M. Collins, and C.R. Racine (1995b)** Persistence of white phosphorus particles in sediment. USA Cold Regions Research and Engineering Laboratory, CRREL Report 95-23.

**Walsh, M.E., C.M. Collins, and R.N. Bailey (1997)** Demonstration of sample compositing methods to detect white phosphorus particles. In *Interagency expanded site investigation: Evaluation of white phosphorus contamination and potential treatability at Eagle River Flats, Alaska*. (C.M. Collins and D. Cate, Ed.). CRREL Contract Report to US Army, Alaska, Directorate of Public Works. FY96 Final Report. p. 35–50.

**Walsh, M.E., C.M. Collins, and R.N. Bailey (1998)** Treatment verification: Monitoring the remediation of white-phosphorus-contami-

nated sediments of drained ponds. In *Interagency expanded site investigation: Evaluation of white phosphorus contamination and potential treatability at Eagle River Flats, Alaska*. (C.M. Collins and D. Cate, Ed.). CRREL Contract Report to US Army, Alaska, Directorate of Public Works. FY97 Final Report. p. 41–62.

**Walsh, M.E., C.M. Collins, and R.N. Bailey (1999)** Treatment verification: Monitoring the remediation of white-phosphorus-contaminated sediments of drained ponds. In *Interagency expanded site investigation: Evaluation of white phosphorus contamination and potential treatability at Eagle River Flats, Alaska*. (C.M. Collins and M.J. Hardenberg, Ed.). CRREL Contract Report to US Army, Alaska, Directorate of Public Works. FY98 Final Report. p. 57–97.

**Walsh, M.E., C.M. Collins, and R.N. Bailey (2000)** Treatment verification: Monitoring the remediation of white-phosphorus-contaminated sediments of drained ponds. In *Remediating and monitoring white phosphorus contamination at Eagle River Flats (Operable Unit C), Fort Richardson, Alaska*. C.M. Collins and M.J. Hardenberg, Ed.). CRREL Contract Report to US Army, Alaska, Directorate of Public Works. FY99 Final Report. p. 49–87.

Appendix Table III-2-A1. 2000 Composite Samples

Pond	Sample Type	Collector	Unique ID	Date Collected	WP Conc. (µg/g)	East (m)	North (m)	Elevation (m)	Type of Subsample	Mass of Composite (kg)	Number of Subsamples in Composite	Analysis Method	Date Analyzed
<b>Area A Spring</b>													
251	Grid	MEW-RNB-CMC	A-1	19-May-00	not detected	353,823.64	6,800,831.13	4.51	a	2.7	48	b	31-May-00
						353,822.68	6,800,825.83	4.65					
						353,801.05	6,800,828.65	4.48					
						353,800.42	6,800,833.82	4.63					
249	Grid	MEW-RNB-CMC	A-2	19-May-00	not detected	353,789.22	6,800,825.53	4.38	a	2.2	48	b	31-May-00
						353,784.01	6,800,825.40	4.37					
						353,783.90	6,800,844.95	4.46					
						353,788.68	6,800,845.59	4.53					
246	Grid	MEW-RNB-CMC	A-3	19-May-00	not detected	353,759.33	6,800,814.33	4.45	a	2.5	48	b	31-May-00
						353,757.85	6,800,809.29	4.46					
						353,737.19	6,800,812.40	4.38					
						353,739.67	6,800,818.96	4.59					
246	Grid	MEW-RNB-CMC	A-4	19-May-00	not detected	353,726.97	6,800,812.63	4.41	a	2.9	48	b	31-May-00
						353,724.71	6,800,807.54	4.52					
						353,706.69	6,800,817.68	4.58					
						353,709.35	6,800,822.40	4.64					
246	Grid	MEW-RNB-CMC	A-5	19-May-00	not detected	353,672.21	6,800,819.19	4.50	a	2.1	40	b	31-May-00
						353,666.84	6,800,819.04	4.41					
						353,666.51	6,800,835.86	4.41					
						353,671.77	6,800,835.85	4.42					
246	Grid	MEW-RNB-CMC	A-6	19-May-00	not detected	353,675.70	6,800,850.13	4.45	a	1.6	40	b	31-May-00
						353,676.74	6,800,844.82	4.50					
						353,660.33	6,800,841.79	4.46					
						353,659.87	6,800,847.40	4.57					
246	Grid	MEW-RNB-CMC	A-7	19-May-00	not detected	353,688.38	6,800,852.87	4.38	a	2.2	48	b	31-May-00
						353,689.51	6,800,847.65	4.36					
						353,709.25	6,800,852.05	4.48					
						353,706.83	6,800,856.52	4.44					
246	Grid	MEW-RNB-CMC	A-8	19-May-00	not detected	353,714.80	6,800,868.89	4.56	a	2.4	48	b	31-May-00
						353,711.33	6,800,872.74	4.30					
						353,724.18	6,800,888.02	4.32					
						353,727.94	6,800,884.31	4.29					
246	Grid	MEW-RNB-CMC	A-9	19-May-00	not detected	353,732.71	6,800,895.57	4.29	a	2.2	48	b	31-May-00
						353,728.95	6,800,899.36	4.31					
						353,741.30	6,800,914.89	4.35					
						353,745.59	6,800,911.30	4.31					
246	Grid	MEW-RNB-CMC	A-10	19-May-00	not detected	353,757.89	6,800,883.84	4.37	a	2.4	48	b	31-May-00
						353,752.35	6,800,884.84	4.37					
						353,747.83	6,800,865.84	4.37					
						353,752.78	6,800,864.22	4.37					
<b>Area A Late Summer</b>													
246	Grid	MEW-RNB-CMC	A-11	17-Aug-00	not detected	353,682.62	6,800,884.31	4.29	a	2.1	48	a, b	19-Sep-00
						353,677.48	6,800,884.36	4.29					
						353,676.96	6,800,905.64	4.29					
						353,682.04	6,800,904.60	4.25					
246	Grid	MEW-RNB-CMC	A-12	17-Aug-00	not detected	353,680.39	6,800,920.74	4.24	a	2.2	48	a, b	19-Sep-00

Type of Subsample: a) Oakfield Core  
Analysis Method: a) Solvent extraction and GC; b) SPME and GC

Appendix Table III-2-A1 (cont'd).

Pond	Sample Type	Collector	Unique ID	Date Collected	WP Conc. (µg/g)	East (m)	North (m)	Elevation (m)	Type of Subsample	Mass of Composite (kg)	Number of Subsamples in Composite	Analysis Method	Date Analyzed
245	Grid	MEW-RNB-CMC	A-13	17-Aug-00	not detected	353,685.14	6,800,923.54	4.25	a	1.9	48	a, b	19-Sep-00
						353,675.27	6,800,941.10	4.36					
						353,670.41	6,800,938.81	4.35					
no #	Grid	MEW-RNB-CMC	A-14	17-Aug-00	not detected	353,645.21	6,800,945.22	4.41	a	2.2	48	a, b	19-Sep-00
						353,633.86	6,800,956.94	4.40					
						353,629.90	6,800,953.35	4.36					
no #	Grid	MEW-RNB-CMC	A-15	17-Aug-00	not detected	353,627.75	6,800,934.72	4.38	a	2.1	48	a, b	19-Sep-00
						353,610.11	6,800,944.15	4.32					
						353,607.77	6,800,939.16	4.34					
no #	Grid	MEW-RNB-CMC	A-16	17-Aug-00	not detected	353,625.53	6,800,929.82	4.47	a	2.2	48	a, b	19-Sep-00
						353,621.48	6,800,904.83	4.32					
						353,619.91	6,800,899.72	4.32					
250	Grid	MEW-RNB-CMC	A-17	17-Aug-00	not detected	353,639.37	6,800,894.18	4.35	a	2.3	48	a, b	19-Sep-00
						353,640.88	6,800,899.46	4.31					
						353,640.90	6,800,876.44	4.36					
no #	Grid	MEW-RNB-CMC	A-18	17-Aug-00	not detected	353,621.17	6,800,873.34	4.33	a	2.2	48	a, b	19-Sep-00
						353,621.57	6,800,868.05	4.37					
						353,641.56	6,800,870.70	4.34					
248	Grid	MEW-RNB-CMC	A-19	17-Aug-00	not detected	353,651.12	6,800,859.97	4.31	a	2.2	48	a, b	19-Sep-00
						353,654.09	6,800,855.54	4.32					
						353,635.84	6,800,845.82	4.32					
no #	Grid	MEW-RNB-CMC	A-20	17-Aug-00	not detected	353,633.24	6,800,850.52	4.33	a	2.3	48	a, b	19-Sep-00
						353,624.81	6,800,836.87	4.32					
						353,616.79	6,800,819.82	4.39					
228	Grid	MEW-RNB-CMC	A-20	17-Aug-00	not detected	353,611.99	6,800,821.84	4.29	a	2.2	48	a, b	19-Sep-00
						353,619.97	6,800,840.13	4.35					
						353,615.28	6,800,853.03	4.30					
Bread Truck Pond	Grid	MEW-RNB-CMC	BT North 100m	18-Aug-00	not detected	353,618.56	6,800,856.99	4.34	a	2.4	48	a, b	19-Sep-00
						353,598.76	6,800,865.86	4.33					
						353,596.86	6,800,860.90	4.34					
109	Grid	MEW-RNB-CMC	Rep 1	18-Aug-00	0.00015	353,512.91	6,800,902.91	4.26	a	3.1	92	a	13-Sep-00
						353,515.49	6,800,907.88	4.31					
						353,496.91	6,800,915.28	4.30					
109	Grid	MEW-RNB-CMC	Rep 2	18-Aug-00	0.00026	354,534.26	6,801,805.62	4.71	a	3.3	92	a	13-Sep-00
						354,528.95	6,801,806.84	4.69					
						354,523.73	6,801,744.54	4.70					
109	Grid	MEW-RNB-CMC	Rep 1	18-Aug-00	0.00012	354,538.77	6,801,826.12	4.73	a	3.1	92	a	13-Sep-00
						354,539.94	6,801,846.02	4.68					
						354,538.67	6,801,825.18	4.70					
109	Grid	MEW-RNB-CMC	Rep 2	18-Aug-00	0.00026	354,533.37	6,801,826.35	4.73	a	3.3	92	a	13-Sep-00
						354,534.26	6,801,805.62	4.71					
						354,518.57	6,801,724.56	4.74					
109	Grid	MEW-RNB-CMC	Rep 1	18-Aug-00	0.00023	354,524.02	6,801,724.59	4.77	a	3.3	92	a	13-Sep-00
						354,518.57	6,801,744.61	4.68					
						354,518.57	6,801,724.56	4.74					

Type of Subsample: a) Oakfield Core  
Analysis Method: a) Solvent extraction and GC; b) SPME and GC

Appendix Table III-2-A1 (cont'd). 2000 Composite Samples.

Pond	Sample Type	Collector	Unique ID	Date Collected	WP Conc. (µg/g)	East (m)	North (m)	Elevation (m)	Type of Subsample	Mass of Composite (kg)	Number of Subsamples in Composite	Analysis Method	Date Analyzed
<b>Area C Spring</b>													
171	Grid	MEW-RNB-CMC	C Marsh 1	17-May-00	not detected	355,134.11	6,801,392.10	4.61	a	2.6	48	a,b	31-May-00
						355,129.40	6,801,394.25	4.51					
						355,138.51	6,801,412.05	4.54					
						355,143.63	6,801,409.88	4.55					
171	Grid	MEW-RNB-CMC	C Marsh 2	17-May-00	0.0288	355,149.86	6,801,413.21	4.54	a	2.4	48	a,b	31-May-00
						355,148.54	6,801,418.28	4.52					
						355,167.51	6,801,424.65	4.51					
						355,169.03	6,801,419.16	4.55					
146	Grid	MEW-RNB-CMC	C Marsh 3	17-May-00	not detected	355,213.89	6,801,337.83	4.57	a	2.3	48	b	31-May-00
						355,218.24	6,801,335.17	4.50					
						355,204.66	6,801,320.38	4.51					
						355,200.85	6,801,324.26	4.47					
146	Grid	MEW-RNB-CMC	C Marsh 4	17-May-00	not detected	355,217.81	6,801,339.08	4.52	a	1.5	32	b	31-May-00
						355,222.28	6,801,342.10	4.58					
						355,229.32	6,801,331.40	4.53					
						355,224.83	6,801,328.35	4.54					
146	Grid	MEW-RNB-CMC	C Marsh 5	17-May-00	not detected	355,190.08	6,801,312.06	4.59	a	2.0	40	b	31-May-00
						355,188.75	6,801,306.72	4.50					
						355,173.07	6,801,310.15	4.50					
						355,173.79	6,801,315.53	4.52					
146	Grid	MEW-RNB-CMC	146-3	17-May-00	0.00009	355,293.12	6,801,150.88	4.42	a	2.2	48	a,b	31-May-00
						355,293.13	6,801,156.45	4.39					
						355,313.03	6,801,152.96	4.39					
						355,312.17	6,801,158.34	4.17					
146	Grid	MEW-RNB-CMC	146-4	17-May-00	0.0047	355,290.99	6,801,174.70	4.25	a	2.2	48	a,b	31-May-00
						355,290.82	6,801,180.38	4.27					
						355,310.90	6,801,177.52	4.04					
						355,310.11	6,801,182.73	4.04					
146	Grid	MEW-RNB-CMC	North 146-1	17-May-00	not detected	355,319.57	6,801,507.00	4.25	a	2.8	48	b	30-May-00
						355,324.87	6,801,506.72	4.05					
						355,318.09	6,801,486.72	4.20					
						355,323.32	6,801,486.21	4.22					
146	Grid	MEW-RNB-CMC	North 146-2	17-May-00	not detected	355,313.26	6,801,472.22	4.14	a	3.6	48	b	30-May-00
						355,318.23	6,801,471.25	4.00					
						355,306.33	6,801,453.67	4.09					
						355,311.64	6,801,453.58	4.16					
<b>Area C Late Summer</b>													
146	Grid	MEW-RNB-CMC	Canoe Pt 1		0.00010	355,333.31	6,801,171.85	4.17	a	1.9	48	b,a	12-Sep-00
					0.00011	355,330.25	6,801,176.99	4.51					
						355,313.46	6,801,168.12	4.11					
						355,312.53	6,801,173.56	4.08					
146	Grid	MEW-RNB-CMC	Canoe Pt 2		0.00076	355,313.46	6,801,168.12	4.17	a	1.9	48	b,a	12-Sep-00
					0.00020	355,312.53	6,801,173.56	4.51					
						355,291.82	6,801,164.47	4.08					

Type of Subsample: a) Oakfield Core  
 Analysis Method: a) Solvent extraction and GC; b) SPME and GC

Appendix Table III-2-A1 (cont'd).

Pond	Sample Type	Collector	Unique ID	Date Collected	WP Conc. (µg/g)	East (m)	North (m)	Elevation (m)	Type of Subsample	Mass of Composite (kg)	Number of Subsamples in Composite	Analysis Method	Date Analyzed
155	Grid	MEW-RNB-CMC	SW	Rep 1 Rep 2	0.034 0.044	355,291.34 355,104.91 355,108.21 355,124.13 355,120.81	6,801,170.11 6,801,538.75 6,801,534.25 6,801,546.75 6,801,551.21	4.22 4.60 4.59 4.58 4.60	a	1.9	48	b,a	12-Sep-00
183	Grid	MEW-RNB-CMC	C100m	Rep 1 Rep 2	0.00042 0.00067	355,036.51 355,027.37 355,037.20 355,020.61 355,026.26 355,026.75 355,022.03	6,801,318.08 6,801,316.54 6,801,312.61 6,801,311.99 6,801,310.95 6,801,303.60 6,801,302.88	4.62 4.64 4.60 4.63 4.64 4.66 4.70	a	1.6	48	b,a	12-Sep-00
<b>Area C/D Spring</b>													
no #	Grid	MEW-RNB-CMC	CD-14	20-May-00	not detected	354,891.88 354,890.65 354,871.44 354,872.75	6,801,985.18 6,801,979.80 6,801,985.81 6,801,991.53	4.38 4.27 4.29 4.30	a	2.7	48	b	30-May-00
no #	Grid	MEW-RNB-CMC	CD-15	22-May-00	not detected	354,900.31 354,895.27 354,887.06 354,891.98	6,802,023.73 6,802,021.22 6,802,039.87 6,802,041.97	4.38 4.35 4.37 4.42	a	3.1	48	b	30-May-00
no #	Grid	MEW-RNB-CMC	CD-16	22-May-00	not detected	354,915.33 354,908.37 354,899.65 354,904.16	6,802,037.91 6,802,035.03 6,802,052.39 6,802,055.44	4.39 4.40 4.37 4.34	a	2.3	48	b	30-May-00
no #	Grid	MEW-RNB-CMC	CD-17	22-May-00	not detected	354,925.12 354,920.11 354,933.82 354,928.89	6,802,043.31 6,802,041.28 6,802,025.84 6,802,023.18	4.40 4.36 4.45 4.42	a	2.9	48	b	30-May-00
no #	Grid	MEW-RNB-CMC	CD-18	22-May-00	not detected	354,898.39 354,896.08 354,915.74 354,916.93	6,802,080.24 6,802,085.63 6,802,093.21 6,802,087.92	4.35 4.39 4.39 4.39	a	2.5	48	b	30-May-00
no #	Grid	MEW-RNB-CMC	CD-19	22-May-00	not detected	354,934.34 354,934.92 354,954.83 354,954.17	6,802,098.13 6,802,103.52 6,802,100.27 6,802,094.97	4.36 4.34 4.35 4.31	a	3.1	48	b	30-May-00
no #	Grid	MEW-RNB-CMC	CD-20	23-May-00	not detected	354,923.33 354,926.34 354,908.95 354,906.21	6,802,121.38 6,802,126.18 6,802,136.17 6,802,131.56	4.32 4.39 4.23 4.20	a	2.4	48	b	30-May-00
59	Grid	MEW-RNB-CMC	CD-21	23-May-00	not detected	354,865.94 354,864.84 354,845.33 354,846.24	6,802,172.28 6,802,177.65 6,802,173.39 6,802,168.05	4.40 4.25 4.37 4.34	a	2.3	48	b	30-May-00
53	Grid	MEW-RNB-CMC	CD-22	23-May-00	not detected	354,931.73 354,937.10	6,802,216.16 6,802,216.98	4.28 4.29	a	2.6	48	b	30-May-00

Type of Subsample: a) Oakfield Core  
Analysis Method: a) Solvent extraction and GC; b) SPME and GC



Appendix Table III-2-A1 (cont'd). 2000 Composite Samples.

Pond	Sample Type	Collector	Unique ID	Date Collected	WP Conc. (µg/g)	East (m)	North (m)	Elevation (m)	Type of Subsample	Mass of Composite (kg)	Number of Subsamples in Composite	Analysis Method	Date Analyzed
						354,940.60	6,802,197.06	4.26					
						354,935.25	6,802,196.30	4.30					
53	Grid	MEW-RNB-CMC	CD-23	23-May-00	not detected	354,954.90	6,802,226.14	4.25	a	2.2	48	b	30-May-00
						354,960.16	6,802,227.75	4.35					
						354,953.93	6,802,246.89	4.33					
						354,948.65	6,802,244.92	4.31					
60	Grid	MEW-RNB-CMC	CD-24	23-May-00	not detected	354,998.59	6,802,204.34	4.29	a	2.8	48	b	30-May-00
						355,003.73	6,802,202.04	4.32					
						354,995.14	6,802,183.88	4.28					
						354,990.26	6,802,185.96	4.28					
61	Grid	MEW-RNB-CMC	CD-25	23-May-00	not detected	354,970.93	6,802,180.82	4.21	a	2.5	48	b	30-May-00
						354,965.98	6,802,182.26	4.29					
						354,962.21	6,802,161.74	4.27					
						354,967.36	6,802,161.10	4.24					
70	Grid	MEW-RNB-CMC	CD-26	23-May-00	not detected	354,990.70	6,802,128.23	4.24	a	2.8	48	b	30-May-00
						354,992.04	6,802,122.98	4.24					
						354,972.58	6,802,117.54	4.27					
						354,971.52	6,802,123.01	4.38					
no #	Grid	MEW-RNB-CMC	CD-27	23-May-00	not detected	354,993.10	6,802,035.82	4.33	a	3.5	48	b	30-May-00
						354,998.55	6,802,035.70	4.35					
						354,993.25	6,802,015.65	4.37					
						354,998.61	6,802,015.48	4.33					
no #	Grid	MEW-RNB-CMC	CD-28	23-May-00	not detected	354,979.14	6,802,017.55	4.19	a	3.1	48	b	30-May-00
						354,978.10	6,802,022.91	4.10					
						354,958.60	6,802,018.68	4.21					
						354,959.53	6,802,013.54	4.40					
no #	Grid	MEW-RNB-CMC	CD-29	23-May-00	not detected	354,942.52	6,802,018.73	4.31	a	3.0	48	b	30-May-00
						354,937.39	6,802,017.61	4.41					
						354,939.41	6,801,997.65	4.31					
						354,944.61	6,801,998.02	4.47					
<b>Area C/D Late Summer</b>													
no #	Grid	MEW-RNB-CMC	CD-30	15-Aug-00	not detected	354,996.53	6,802,243.06	4.13	a	2.5	48	b,a	19-Sep-00
						355,001.03	6,802,240.05	4.36					
						354,989.28	6,802,223.76	4.34					
						354,984.68	6,802,226.67	4.35					
no #	Grid	MEW-RNB-CMC	CD-31	15-Aug-00	not detected	355,003.81	6,802,274.57	4.33	a	2.4	48	b,a	19-Sep-00
						355,003.66	6,802,269.34	4.35					
						354,983.64	6,802,268.57	4.39					
						354,983.36	6,802,274.18	4.38					
no #	Grid	MEW-RNB-CMC	CD-32	15-Aug-00	not detected	355,017.17	6,802,253.03	4.29	a	2.5	48	b,a	19-Sep-00
						355,011.98	6,802,253.22	4.28					
						355,010.51	6,802,273.23	4.30					
						355,015.79	6,802,273.70	4.33					
no #	Grid	MEW-RNB-CMC	CD-33	15-Aug-00	not detected	355,043.83	6,802,282.57	4.17	a	2.9	48	b,a	19-Sep-00
						355,047.97	6,802,279.37	4.26					
						355,032.98	6,802,264.54	4.27					
						355,029.43	6,802,268.54	4.27					

Type of Subsample: a) Oakfield Core  
Analysis Method: a) Solvent extraction and GC; b) SPME and GC

Appendix Table III-2-A1 (cont'd).

Pond	Sample Type	Collector	Unique ID	Date Collected	WP Conc. (µg/g)	East (m)	North (m)	Elevation (m)	Type of Subsample	Mass of Composite (kg)	Number of Subsamples in Composite	Analysis Method	Date Analyzed
44	Grid	MEW-RNB-CMC	CD-34	15-Aug-00	not detected	355,040.97	6,802,312.04	4.13	a	2.6	48	b,a	19-Sep-00
						355,046.18	6,802,312.55	4.22					
						355,044.30	6,802,290.94	4.18					
						355,039.39	6,802,292.04	4.26					
no #	Grid	MEW-RNB-CMC	CD-35	15-Aug-00	not detected	355,038.34	6,802,282.79	4.24	a	2.6	48	b,a	19-Sep-00
						355,042.96	6,802,285.47	4.18					
						355,052.19	6,802,246.30	4.27					
						355,047.24	6,802,244.64	4.14					
64	Grid	MEW-RNB-SB	CD-36	16-Aug-00	not detected	355,115.56	6,802,171.83	4.32	a	2.6	48	b,a	19-Sep-00
						355,113.61	6,802,166.72	4.24					
						355,095.32	6,802,175.19	4.28					
						355,097.71	6,802,180.00	4.27					
63	Grid	MEW-RNB-CMC	CD-37	15-Aug-00	not detected	355,140.74	6,802,174.21	4.16	a	2.7	48	b,a	19-Sep-00
						355,140.51	6,802,179.50	4.20					
						355,120.46	6,802,180.27	4.15					
						355,120.28	6,802,174.85	4.35					
no #	Grid	MEW-RNB-CMC	CD-38	15-Aug-00	not detected	355,123.48	6,802,190.83	4.20	a	2.5	48	b,a	19-Sep-00
						355,124.95	6,802,185.81	4.35					
						355,143.94	6,802,192.90	4.28					
						355,142.23	6,802,198.06	4.28					
62	Grid	MEW-RNB-CMC	CD-39	15-Aug-00	not detected	355,153.18	6,802,193.71	4.14	a	2.8	48	b,a	19-Sep-00
						355,158.36	6,802,194.57	4.20					
						355,160.23	6,802,174.10	4.22					
						355,155.26	6,802,173.72	4.22					
72	Grid	MEW-RNB-SB	CD-40	16-Aug-00	not detected	355,139.74	6,802,141.40	4.60	a	2.6	48	b,a	19-Sep-00
						355,139.07	6,802,146.79	4.15					
						355,119.32	6,802,144.57	4.15					
						355,118.90	6,802,139.96	4.19					
no #	Grid	MEW-RNB-SB	CD-41	16-Aug-00	not detected	355,097.74	6,802,141.84	4.22	a	2.3	48	b,a	19-Sep-00
						355,117.16	6,802,136.92	4.11					
						355,116.44	6,802,131.71	4.15					
						355,097.15	6,802,136.71	4.41					
no #	Grid	MEW-RNB-SB	CD-42	16-Aug-00	not detected	355,093.82	6,802,138.32	4.00	a	2.5	48	b,a	19-Sep-00
						355,090.61	6,802,142.44	4.10					
						355,073.11	6,802,132.52	4.17					
						355,075.72	6,802,127.90	4.24					
no #	Grid	MEW-RNB-SB	CD-43	16-Aug-00	not detected	355,046.70	6,802,098.40	4.21	a	2.6	48	b,a	19-Sep-00
						355,042.22	6,802,101.34	4.21					
						355,031.38	6,802,084.62	4.30					
						355,036.24	6,802,082.33	4.17					
no #	Grid	MEW-RNB-SB	CD-44	16-Aug-00	not detected	355,033.85	6,802,079.04	4.42	a	2.8	48	b,a	19-Sep-00
						355,028.98	6,802,080.41	4.22					
						355,020.76	6,802,061.99	4.20					
						355,025.48	6,802,059.27	4.24					
49	Grid	MEW-RNB-CMC	CD-45	15-Aug-00	not detected	355,179.15	6,802,252.28	4.24	a	2.0	48	b,a	19-Sep-00
						355,177.41	6,802,257.69	4.06					
						355,194.78	6,802,265.63	4.08					

Type of Subsample: a) Oakfield Core  
 Analysis Method: a) Solvent extraction and GC; b) SPME and GC

Appendix Table III-2-A1 (cont'd). 2000 Composite Samples.

Pond	Sample Type	Collector	Unique ID	Date Collected	WP Conc. (µg/g)	East (m)	North (m)	Elevation (m)	Type of Subsample	Mass of Composite (kg)	Number of Subsamples in Composite	Analysis Method	Date Analyzed
<b>Racine Island</b>													
285	Grid	MEW-RNB-SB	Bento 1	18-Aug-00	1.08	355,197.40	6,802,260.87	4.13					
						355,211.64	6,800,499.42	4.63	a	2.0	48	b,a	31-Aug-00
						355,209.57	6,800,494.12	4.64					
						355,190.63	6,800,499.23	4.76					
						355,192.16	6,800,504.58	4.74					
285	Grid	MEW-RNB-SB	Bento 2	18-Aug-00	0.023	355,178.56	6,800,515.38	4.74	a	2.1	48	b,a	31-Aug-00
						355,172.70	6,800,515.53	4.73					
						355,175.01	6,800,491.75	4.70					
						355,176.64	6,800,495.25	4.67					
285	Grid	MEW-RNB-SB	Bento 3	18-Aug-00	0.054	355,211.92	6,800,505.58	4.77	a	1.6	32	b,a	31-Aug-00
						355,215.85	6,800,506.30	4.64					
						355,218.87	6,800,493.65	4.64					
						355,213.21	6,800,492.78	4.67					
285	Grid	MEW-RNB-SB	Bento 4	18-Aug-00	6.90	355,308.90	6,800,487.34	4.57	a	1.7	32	b,a	31-Aug-00
						355,313.98	6,800,486.55	4.76					
						355,312.46	6,800,473.29	4.68					
						355,307.20	6,800,474.64	4.68					
285	Grid	MEW-RNB-SB	Bento 5	18-Aug-00	0.060	355,312.39	6,800,470.31	4.70	a	2.3	48	b,a	31-Aug-00
						355,315.55	6,800,474.90	4.64					
						355,332.03	6,800,463.55	4.90					
						355,329.09	6,800,459.10	4.72					

Type of Subsample: a) Oakfield Core  
 Analysis Method: a) Solvent extraction and GC; b) SPME and GC

## III-3. COMPOSITE SAMPLING AND ANALYSIS FOR WHITE PHOSPHORUS IN UNTREATED PONDS

**Marianne E. Walsh, Charles M. Collins, and Ronald N. Bailey**  
U.S. Army Cold Regions Research and Engineering Laboratory

### INTRODUCTION

We continued sampling in Areas A and C/D in an effort to locate additional areas of white phosphorus contamination that might be sources of waterfowl poisoning. The locations of recovered carcasses of telemetry mallards indicated that localized areas of contamination that have not yet been identified may still be present in Northern C, Area C/D, and possibly Area A. The major ponds within these areas have already been extensively sampled to try to identify areas of contamination. Over the last two years we have been collecting grid composite samples in smaller ponds within these areas that in the past either have not been sampled or have had only cursory sampling. In 1999 we collected 32 grid composite samples from Ponds 226 and 228 in Area A and 27 composites from Area C/D and Coastal East. We found one positive sample in Area A Pond 226 and one in Pond 75 of Coastal East. Neighboring samples were blank, indicating that the contamination was not widespread, as in Pond 183 in Area C, Racine Island, or the Bread Truck Pond. Telemetry data for birds that died in 1999 and had white phosphorus in their gizzards seemed to indicate that most of these birds

picked up the white phosphorus in Area C/D or Northern C. This year we concentrated our efforts in these two areas but also collected samples in an additional complex of small ponds in the northern part of Area A.

### METHODS

We collected composite samples consisting of 31-mL subsamples taken at the nodes of a 1.82-m-square grid. Each composite was made up of a maximum of 48 subsamples that we collected to a depth of 10 cm using an Oakfield corer. The outside dimensions of each gridded area were 5.46 m wide and up to 20.02 m long. The spacing between composite samples was governed by the shapes of the ponds.

White phosphorus was determined by gas chromatography (EPA SW-846 Method 7580) as described elsewhere in this report in the section on the monitoring of the remediation of white-phosphorus-contaminated sediments in treated ponds (M.E. Walsh et al., this volume).

Universal Transverse Mercator (UTM) horizontal coordinates (North American Datum 1927) and elevations were obtained using a

Wild Total Station. Surveying methods were similar to those described in past years. For Area A we used a benchmark established in 1998 near Pond 258. Area C locations were obtained from a benchmark on Clunie Pad. Area C/D locations were obtained from a benchmark established this year near Pond 730.

### Northern A

We collected 20 grid composites from ponds northwest of the pumped Ponds 256 and 258 (Fig. III-3-1 and III-3-2). Ten samples were from Pond 246, and the remainder were from small ponds near Pond 246. Approximately 20 discrete samples were collected from this region of Area A during investiga-

tions from 1991 to 1994. Only two positive sediment samples were found (Samples #322 and 323) (Racine et al. 1993). These samples were collected in May 1991 at points 25 and 50 m southwest of the observation tower; however, subsequent samples in August 1992, when cores to 30-cm depth were taken, were blank.

In 1999, nine of the 24 telemetry bird mortalities attributed to white phosphorus poisoning were in Area A. However, white phosphorus was found in only one of these ducks, and the “last alive” signal from this bird was from Area C. Despite the uncertainties associated with the remaining mortalities, we felt that it was important to continue sampling in Area A. We wanted to determine if there were

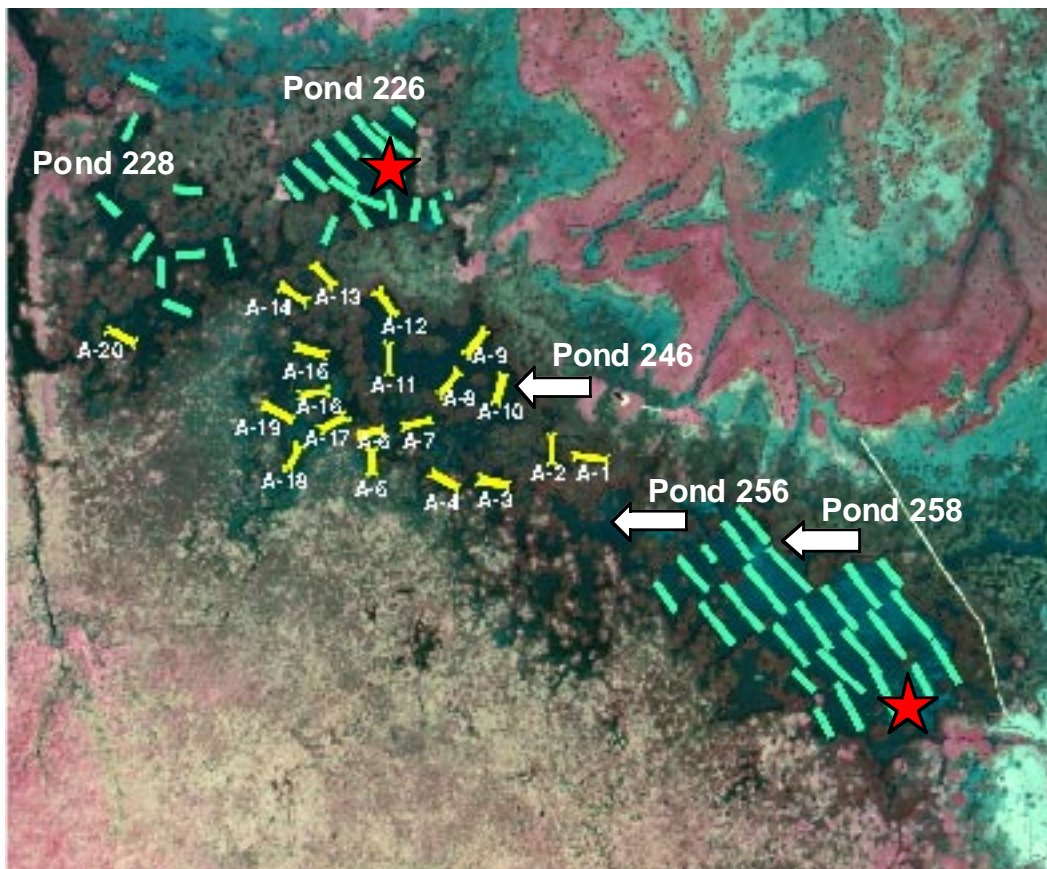

Figure III-3-1. Aerial photo (Aeromap 18 August 1998) with locations of 2000 grid composites (yellow) and 1998–1999 grid composites (green). Red stars indicate locations where white phosphorus was detected.

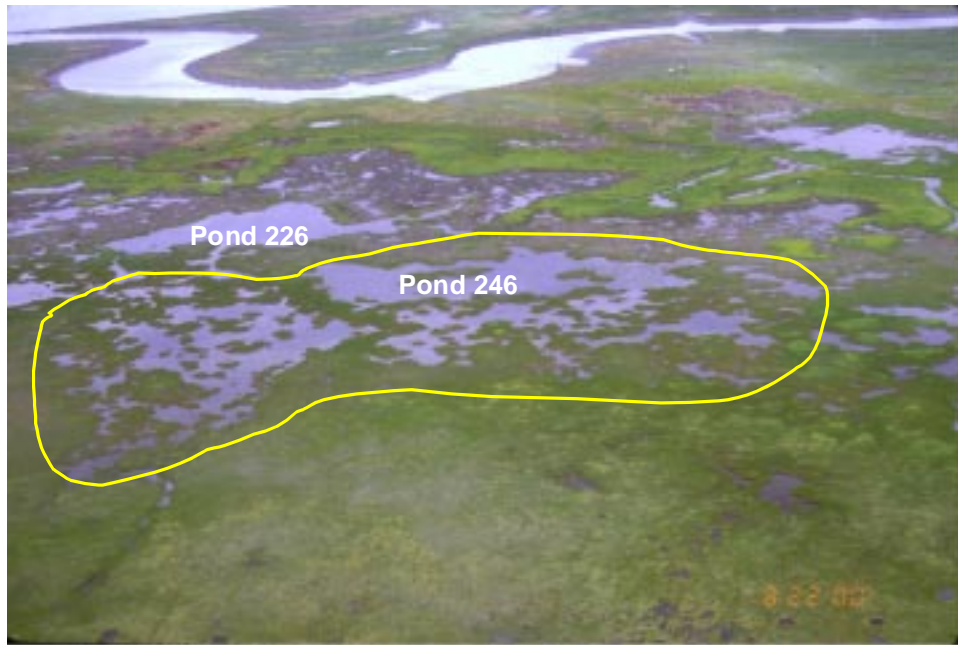

Figure III-3-2. Oblique view of region from which Composites A-1 to A-19 were collected in May and August 2000. No white phosphorus was detected. (Photograph taken 22 August 2000.)

indeed isolated hotspots of contamination in the ponds that had been missed in previous sampling efforts. Also, every pond sampled and found uncontaminated could be eliminated as a potential source and dropped from consideration for future remediation actions.

#### Area C/D

This area is composed of a large complex of small open water pools, most less than 25 m in length, among a sedge and bulrush marsh. A very few large ponds, such as Pond 40, border the area to the south and east. The boundaries of these small open water pools have changed over the years, and many have not been mapped as separate ponds in the ERF GIS database. We collected 32 additional grid composite samples from open water pools in the marsh to the north and west of Pond 40 (Fig. III-3-3 and III-3-4.). We selected all available pools within this area that were large enough (stretching at least 20 m in one dimension) to lay out a composite grid. Sixteen discrete samples were collected in August 1992 near the southernmost grid com-

posites collected this year. All previous samples were blank. However, in 1999, six telemetry birds died in Area C/D, five of which had white phosphorus in their gizzards.

#### Northern C

The large permanent ponds (183 and 146) of Area C have been extensively sampled, and white phosphorus has been found at high concentrations in these ponds. The pond/marsh complex on the north end of Area C has not been extensively sampled except for Pond 155, which was highly contaminated with white phosphorus. Pond 155 is the largest pond of about a dozen small ponds that have been mapped within the marsh. Like Area C/D, pond boundaries are not well defined and have changed over time. Given that six of the telemetry mortalities that had white phosphorus in their gizzards used the marsh in Area C just prior to their death, the small ponds within this marsh may be a source of poisoning. In May 2000 we collected grid composites from ponds within the marsh that had

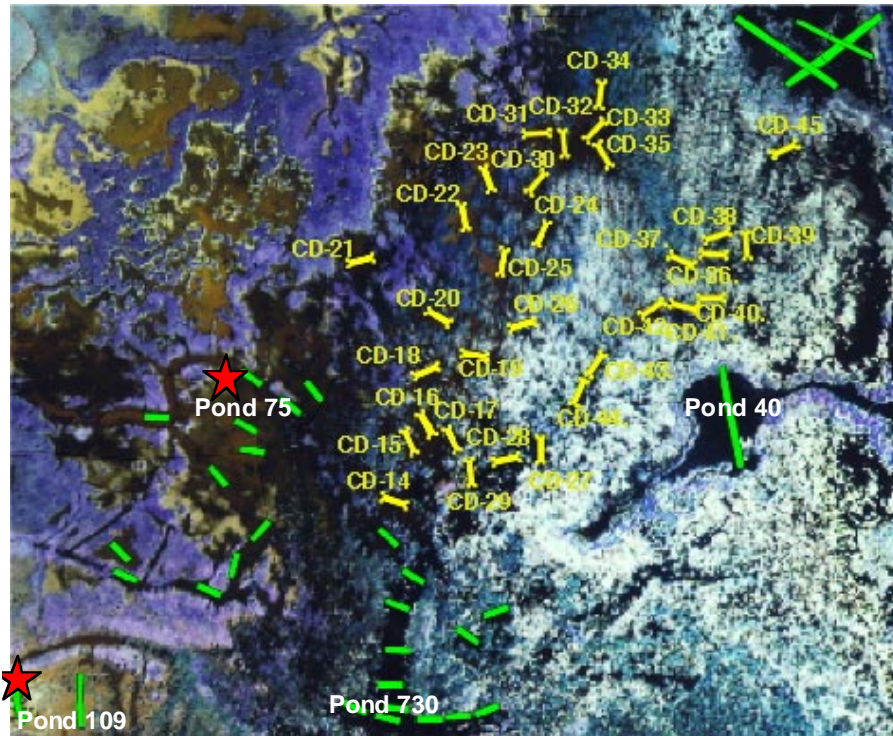

Figure III-3-3. Aerial photo (Aeromap 8 September 2000) of Area C/D (Coastal East and Bread Truck Pond 109) with locations of 2000 grid composites (yellow) and 1997–1999 grid composites (green). The red star indicates the location where white phosphorus was detected.



Figure III-3-4. Aerial oblique view of Area C/D north of Pond 40 from which grid composite samples were collected in 2000. No white phosphorus was found. (Photograph taken 22 August 2000.)

open water stretching at least 20 m in one dimension. We also collected two grid composites from the undrained portion of Pond 146, located north of Clunie Inlet (Fig. III-3-5). A small beaver dam separates this portion of the pond from Clunie Inlet and prevents water from draining completely to the pump sump in the southern end of Pond 146.

## RESULTS AND DISCUSSION

### Northern A and C/D

We did not detect white phosphorus in any of the grid composites collected this year in

Areas A or C/D. The regions we sampled are not likely sources of waterfowl poisonings.

### Northern C

Area C/D borders the marsh in Northern Area C. Our sampling this year detected white phosphorus in Pond 171, located due south of Pond 155. The concentration found was  $0.03 \mu\text{g/g}$ . Because we know how many subsamples made up this grid composite, we can calculate the maximum possible concentration in a subsample simply by multiplying the number of subsamples (48) by the concentration. The composite concentration was  $0.03 \mu\text{g/g}$  and there were 48 subsamples, so

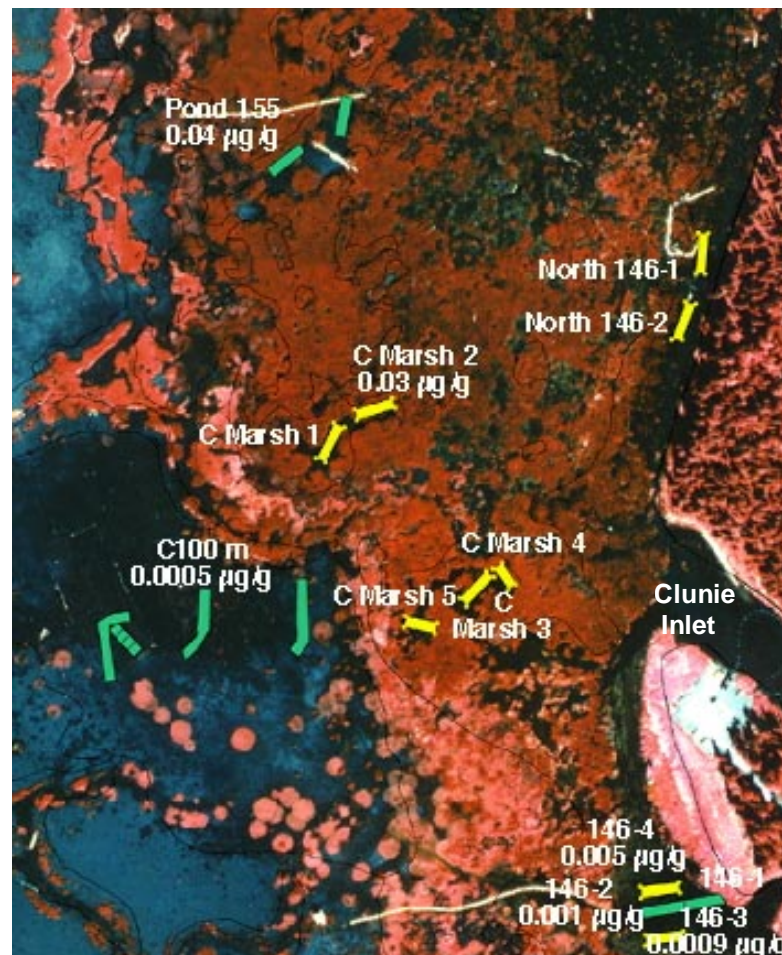

Figure III-3-5. Aerial photo (Aeromap 16 August 1995) with locations of 2000 grid composites (yellow) and 1997–1999 grid composites (green). For those samples in which white phosphorus was detected in 2000, concentrations are shown.



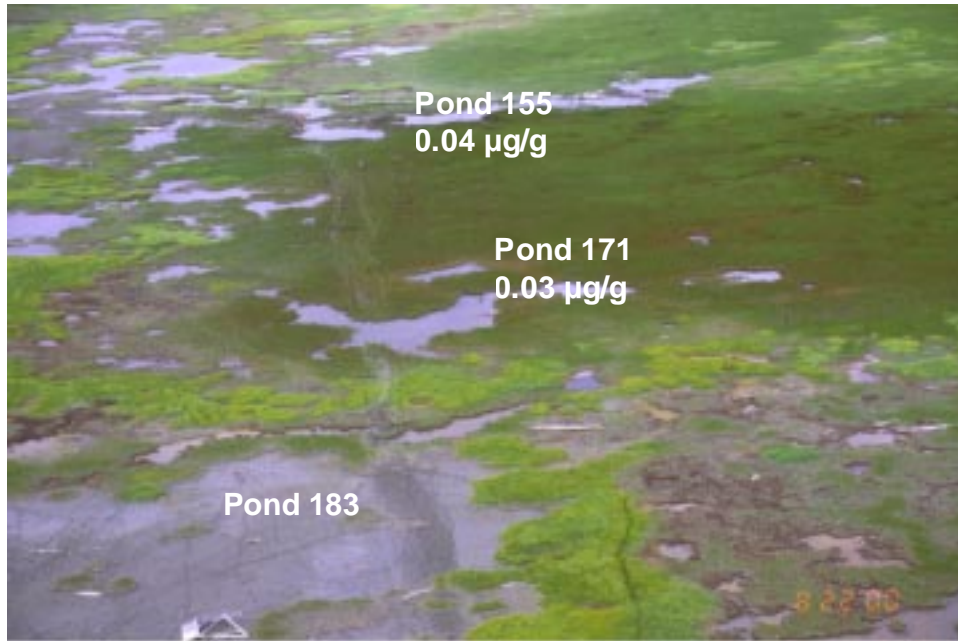

Figure II-3-6. Oblique view of the north part of Pond 183 and the adjoining marsh where white phosphorus was found this year. (Photograph taken 22 August 2000.)

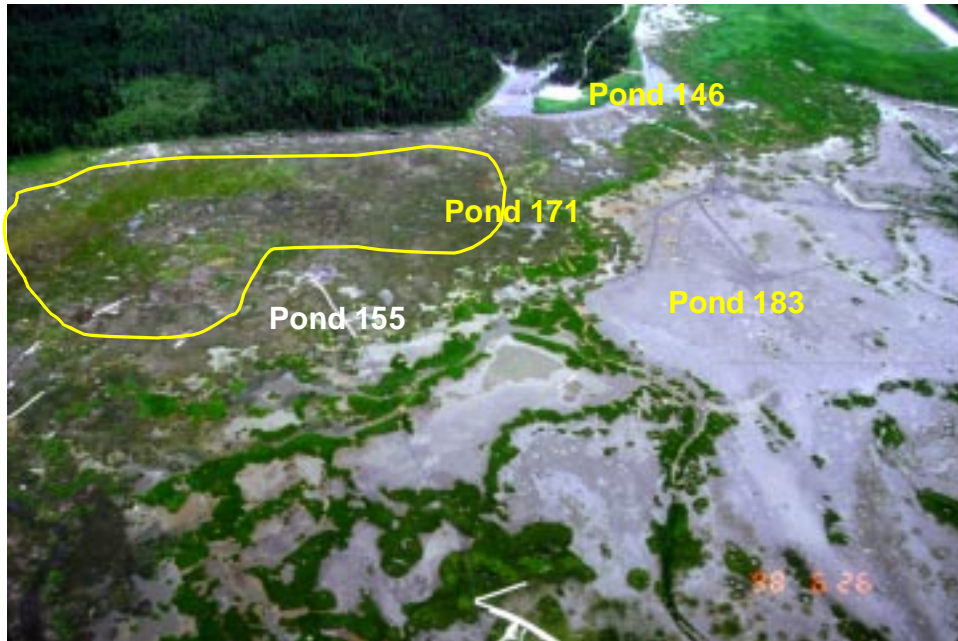

Figure III-3-7. Oblique view of marsh in Area C. Encircled area has not been sampled for white phosphorus. (Photograph taken 26 June 1998.)

the maximum possible concentration in a subsample would be 1.4  $\mu\text{g/g}$ . Previously we have observed that sediment samples with white phosphorus concentrations above 1  $\mu\text{g/g}$  frequently contain macroscopic white phosphorus particles, the form lethal to waterfowl.

We did not sample further in Northern C because we were concentrating our efforts in Area C/D. Since we did not detect any white phosphorus in Area C/D, next year we will focus on the marsh in Northern C (Fig. III-3-7), even though open water habitat makes up a relatively small part of the marsh. However, the dynamic nature of the pond borders implies that we now must expand our composite sampling beyond open water ponds. Although there are no large ponds, there are a number of very small open water pools within the sedge marsh. These very small pools are used to some degree by dabbling ducks, especially mallards.

## CONCLUSIONS

Our 2000 sampling results did not reveal any reservoirs of white phosphorus in Areas A or C/D. The marsh of Northern C, which was never sampled intensively because of a dearth of open water habitat, may be the source of the continued poisonings of telemetry birds.

## REFERENCE

**Racine, C.H., M.E. Walsh, C.M. Collins, D. Lawson, K. Henry, L. Reitsma, B. Steele, R. Harris, and S.T. Bird (1993)** White phosphorus contamination of salt marsh sediments at Eagle River Flats, Alaska. CRREL Contract Report to the US Army Environmental Center, Aberdeen Proving Ground, MD, AEC Report No. ENAEC-IR-CR-93063.



## III-4. 2000 WEATHER DATA FOR EAGLE RIVER FLATS

**Charles M. Collins**

U.S. Army Cold Regions Research and Engineering Laboratory

### INTRODUCTION

Weather is one the three major parameters affecting the success of the remediation process in Eagle River Flats. It is also the one parameter that we cannot control. The other parameters are the water levels in the ponds, which we can control with the automated pump systems, and flooding from the tides, which we are partially able to control with the tide gates that we have installed at the heads of a number of the tidal gullies.

To quantify local weather conditions in Eagle River Flats, a meteorological data station was installed at the edge of the EOD pad in May 1994 (Haugen 1995), and air temperature, radiation, precipitation, and evaporation data have been collected every summer since then. In 1998 the meteorological station was revamped with a new, higher 4-m tower and updated sensors and data collection procedures (Collins 1999). A cell phone connection was used to download the meteorological data automatically on a daily basis to a computer in CRREL-Hanover. Additionally, four dataloggers installed in several of the treated ponds were linked to the meteorological station by radio telemetry so that soil moisture conditions could also be transmitted to the

meteorological station and then retransmitted daily by the cell phone along with the meteorological data to Hanover. The daily meteorological data and the pond data were displayed on the Eagle River Flats Web Page, linked to the CRREL Public Web Site (Collins 1999).

In 1999, unreliable cell phone connections prevented the meteorological data from being posted to the Web site on a daily basis as we had planned. All the data were stored and preserved in the datalogger and downloaded later, but the concept of data being posted to the Web site on a daily basis and accessible to researchers was not successful (Collins 2000). This year, to overcome that problem, the cell phone link was eliminated. Instead, a base station was set up at Route Bravo Bridge and wired into a hardwire telephone line. The base station would poll the meteorological station and the four dataloggers in turn by radio and download the daily data. The data would then be transmitted by a modem through the phone line to Hanover, resulting in a much more reliable and timely posting of the meteorological data on the Web page. This base station at Route Bravo Bridge also supported the Web camera system described elsewhere (Williams, this volume).



Figure III-4-1. Eagle River Flats meteorological station located off the edge of the EOD Pad. The 4-m tower is located in the right center, the 1.22-m-diameter evaporation pan is located to the right, and the shielded rain gage is located to the left.

## METEOROLOGICAL STATION

The Eagle River Flats meteorological station is located off the edge of the EOD pad on a small gravel pad extending into the salt marsh of Area C (Fig. III-4-1.) The 4-m guyed tower has a wind anemometer mounted on top that records wind direction and speed; it is high enough to be above any effects caused by the edge of the nearby EOD pad. Air temperature and relative humidity sensors within standard shields are located at 2-m and 0.5-m heights on the tower. A side arm at 2 m holds two Epply radiation sensors for measuring incoming and reflected short-wave (0.3 to 3  $\mu\text{m}$ ) radiation. A white fiberglass enclosure mounted on the tower contains the Campbell Scientific (Logan, UT) datalogger system consisting of a CR10 Measurement and Control Module and an SM716 Storage Module. All meteorological data collected for the season are stored in the storage module. Also mounted in the enclosure is a Motorola P50 radio for communicating between the met sta-

tion and the base station at Route Bravo Bridge. The antenna for the radio is attached to the top of the 4-m tower. A wind-shielded precipitation gage is located 5 m east of the tower. A standard 1.22-m- (48-in.) diameter evaporation pan is located 2 m west of the tower. A Druck pressure transducer mounted on the bottom of the evaporation pan measures water depth. A 12-V battery provides power to the station, and a solar panel mounted on the tower keeps the battery charged. The instruments of the meteorological station are summarized in Table III-4-1.

## RESULTS

The meteorological station was restarted for the summer season on 12 May 2000. The station was much more reliable than last year. The elimination of the cell phone link in favor of a radio link to a base station at Route Bravo Bridge and then a telephone line link

**Table III-4-1. Summary of meteorological station instruments and the parameters measured.**

<i>Instrument</i>	<i>Parameter Measured</i>
R.M. Young wind anemometer 4-m height	Average wind speed (m/s) Average wind direction (m/s) Peak wind speed (m/s) Time of peak wind speed
(2) Air temperature sensors 2- and 0.5-m heights	Average 2-m temperature (°C) Maximum 2-m temperature (°C) Minimum 2-m temperature (°C) Average 0.5-m temperature (°C) Maximum 0.5-m temperature (°C) Minimum 0.5-m temperature (°C)
(2) Relative humidity sensors 2- and 0.5-m heights	Average 2-m relative humidity (%) Maximum 2-m relative humidity (%) Minimum 2-m relative humidity (%) Average 0.5-m relative humidity (%) Maximum 0.5-m relative humidity (%) Minimum 0.5-m relative humidity (%)
(2) Epply radiation (0.3-3 µm) sensors, incident and reflected	Average short-wave incident radiation (W/m <sup>2</sup> ) Average short-wave reflected radiation (W/m <sup>2</sup> )
Tipping bucket rain gage	Tipping bucket 15-min precipitation (mm) Tipping bucket total daily precipitation (mm)
Druck 357/D pressure transducer	Evaporation pan water level 15-min sample

ensured that data were transmitted in a timely manner to Hanover and posted regularly to the Web site. Terry Edwards and other personnel of Weldin Construction checked the meteorological station periodically through-

out the summer, ensuring that the equipment stayed in operating condition. They also added make-up water to the evaporation pan twice during the summer.

Table III-4-2 summarizes the weather data

**Table III-4-2. Monthly summary of temperatures and precipitation for Eagle River Flats and Anchorage showing the 2000 monthly (or partial monthly) average temperatures for both sites, the normal monthly average temperatures for Anchorage, the monthly total measured precipitation for ERF, and the monthly total and normal average precipitation for Anchorage.**

	<i>Temperature (°C)</i>			<i>Rainfall (mm)</i>		
	<i>ANC normal</i>	<i>ANC 2000</i>	<i>ERF 2000</i>	<i>ANC normal</i>	<i>ANC 2000</i>	<i>ERF 2000</i>
May	8.1	7.9	–	18.5	27.7	–
12–31 May	–	8.5	8.1	–	23.6	22.8
June	12.4	12.8	12.7	29.0	39.6	27.4
July	14.7	13.8	13.4	43.4	72.1	116.4
August	13.5	12.8	–	62.0	51.3	–
1–14 August	–	14.3	13.4	–	15.1	32.6
September	9.1	8.5	–	68.6	89.0	–

for Eagle River Flats for May through August. The monthly average temperatures for Eagle River Flats and the National Weather Service (NWS) station at Anchorage are presented along with the normal monthly temperatures for Anchorage. The NWS Anchorage data are presented along with the Eagle River Flats data because we do not have a long-term average for the Eagle River Flats site. Additionally the monthly total rainfall for Eagle River Flats and Anchorage is shown along with the normal monthly rainfall for Anchorage. The summer of 2000 had normal to slightly above-normal temperatures for May and June. Temperatures were below normal for August and September. Precipitation was above normal for every month except August for the Anchorage NWS site. Precipitation at Eagle River Flats was less than for Anchorage for May and June, reflecting the localized nature of convection rainfall events normally occurring

during this period. Precipitation in July and the first half of August was greater for Eagle River Flats than Anchorage NWS, reflecting both the more widespread synoptic storm systems common later in the summer and the closer location of Eagle River Flats to the mountains.

May and June are normally the driest months of the core drying season needed for treating contaminated pond bottom sediments. This year the timing of the last spring flooding tide in early May allowed us to deploy equipment and pump the ponds out so that we could take advantage of the warmer temperatures of late May to start the drying process. June and early July provided nearly ideal drying conditions except for an occasional rainstorm.

Figure III-4-2 is a plot of the maximum, minimum, and average air temperatures for the summer. There were thirty-eight days

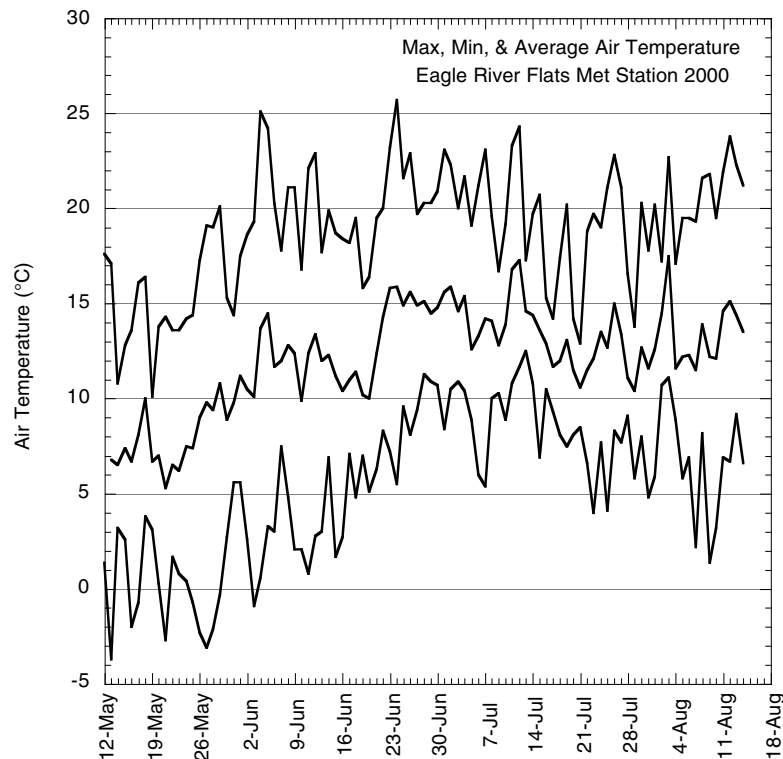

Figure III-4-2. Maximum, minimum, and average air temperatures for the Eagle River Flats meteorological station from 12 May to 15 August 2000. Thirty-eight days had maximum temperatures of 20°C or more.

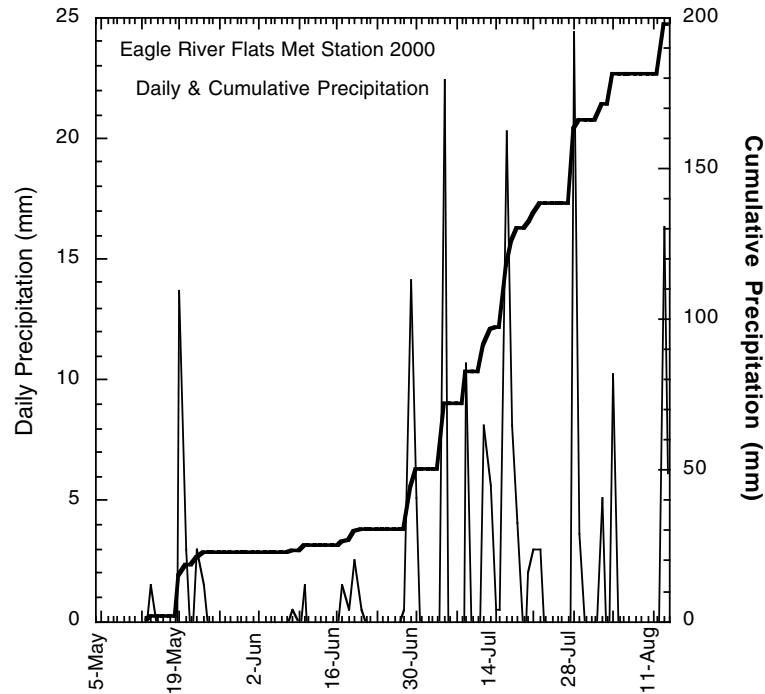

Figure III-4-3. Daily precipitation and cumulative precipitation for the season from 12 May to 15 August 2000 at the ERF meteorological station, showing the dry spell from late May through 28 June that contributed to the excellent drying conditions in the treated ponds.

from mid-May to mid-August 2000 with maximum temperatures of 20°C or more. This compares to only thirty days during the summer of 1999 and only eighteen days during the summer of 1998. Precipitation was minimal from late May through almost all of June (Fig. III-4-3), with a precipitation total from 24 May through 28 June of only 8 mm. Thirteen of the days with maximum temperatures of 20°C or more also occurred in this dry spell, contributing to the excellent sediment drying conditions during this period. Rainstorms on 29 and 30 June, totaling 19 mm, began a period through the rest of the summer where showers every few days frequently remoistened the drying pond sediments and reduced the effectiveness of the remediation. The largest single one-day rainfall event this summer occurred on 28 July, with 24 mm of rain.

The warm, dry period of late May through late June is also apparent in the plot of average incoming and reflected short-wave radiation (Fig. III-4-4). Clear, sunny days, indicated

on the record by an average incident radiation above 250 W/m<sup>2</sup>, are abundant throughout June. Finally, the warm drying conditions in late May and June can be seen in the cumulative evaporation data from the 1.22-m evaporation pan (Fig. III-4-5). The evaporation is greatest, reflected by the steepness of the curve, from 26 May through early July.

The daily meteorological data for the entire summer season are summarized in Table III-4-3. More detailed data that include all the 15-minute observations and additional measured parameters are available from CRREL in an Excel spreadsheet format if needed.

## REFERENCES

**Collins, C.M.** (2000) 1999 weather data for Eagle River Flats. In Collins, C.M. and M.J. Hardenberg (Ed.) (2000) Remediating and Monitoring White Phosphorus Contamination at Eagle River Flats (Operable Unit C),



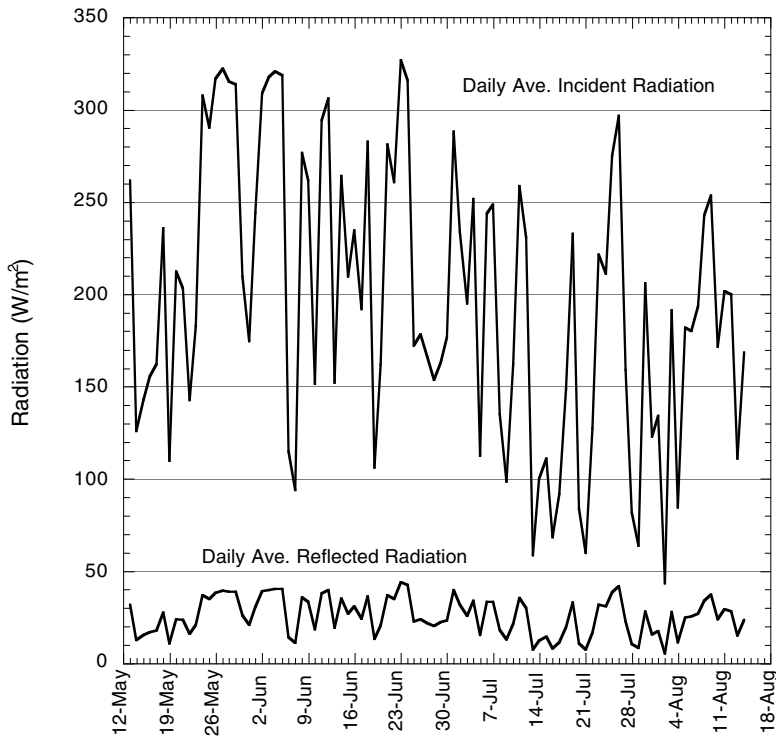

Figure III-4-4. Plot of average incoming (incident) and reflected short-wave (0.3 to 3 μm) radiation for period of 12 May through 15 August. The warm dry period of late May through late June with a number of clear sunny days is apparent in the incoming radiation record. Clear, sunny days are indicated on the record by an average incident radiation above 250 W/m<sup>2</sup>.

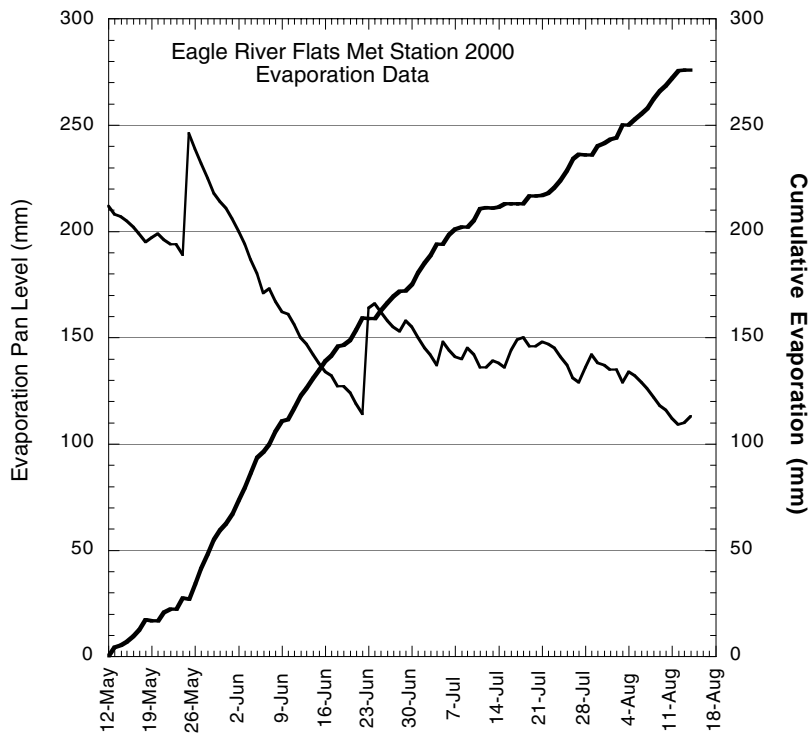

Figure III-4-5. Evaporation pan data showing the evaporation pan water level data and the net cumulative evaporation for the season. The steepness of the net cumulative curve in June reflects the warm temperatures and good drying conditions during this period. The evaporation pan water level data show the decrease in the water level due to evaporation, the addition of make-up water on 25 May and 23 June, and the contribution from periodic rainstorms throughout July.

**Table III-4-3. Daily climatic data for Eagle River Flats meteorological station during May–August 2000.**

Date	Air temp. maximum (°C)	Air temp. average (°C)	Air temp. minimum (°C)	Precipitation (mm)	Wind speed average (m/s)	Wind speed maximum (m/s)	Radiation (0.3 to 3 $\mu\text{m}$ ) ( $\text{W}/\text{m}^2$ )	
							Incident	Reflected
13-May	17.1	6.8	-3.7	0.0	1.9	6.7	261.7	31.7
14-May	10.8	6.5	3.2	1.5	1.6	5.9	125.9	12.8
15-May	12.8	7.4	2.6	0.0	1.6	4.8	143.2	15.4
16-May	13.6	6.7	-2.0	0.0	1.4	4.1	155.6	16.9
17-May	16.1	8.1	-0.7	0.0	1.3	5.6	162.4	18.0
18-May	16.4	10.0	3.8	0.0	2.0	7.2	235.8	27.7
19-May	10.1	6.7	3.1	13.7	1.2	5.1	109.8	10.7
20-May	13.8	7.0	0.3	3.0	2.1	8.5	212.4	24.2
21-May	14.3	5.3	-2.7	0.0	1.4	6.9	203.3	23.7
22-May	13.6	6.5	1.7	3.0	1.4	7.5	142.7	16.0
23-May	13.6	6.2	0.8	1.5	2.2	8.2	183.0	21.1
24-May	14.2	7.5	0.4	0.0	2.3	6.1	307.5	37.1
25-May	14.4	7.4	-0.7	0.0	2.1	9.0	290.4	34.8
26-May	17.3	9.0	-2.3	0.0	1.9	7.9	317.0	38.4
27-May	19.1	9.8	-3.1	0.0	1.9	6.7	322.6	39.6
28-May	19.0	9.4	-2.1	0.0	1.9	6.9	315.3	39.1
29-May	20.1	10.8	-0.3	0.0	1.7	5.9	313.9	39.0
30-May	15.3	8.9	2.7	0.0	2.2	7.4	209.8	26.1
31-May	14.4	9.8	5.6	0.0	1.5	5.1	174.6	21.0
1-Jun	17.5	11.2	5.6	0.0	1.5	5.6	244.3	30.6
2-Jun	18.6	10.5	2.6	0.0	2.0	5.3	308.9	39.2
3-Jun	19.3	10.1	-0.9	0.0	1.5	5.0	317.7	39.8
4-Jun	25.1	13.7	0.6	0.0	1.7	5.7	320.6	40.5
5-Jun	24.2	14.5	3.3	0.0	1.7	5.7	318.6	40.6
6-Jun	20.3	11.7	3.0	0.0	2.5	12.9	115.0	14.2
7-Jun	17.8	12.0	7.5	0.0	2.0	11.8	94.1	11.2
8-Jun	21.1	12.8	4.8	0.5	1.7	7.0	276.6	35.8
9-Jun	21.1	12.4	2.1	0.0	1.4	4.6	261.6	33.3
10-Jun	16.8	9.9	2.1	1.5	1.1	5.0	151.3	18.7
11-Jun	22.1	12.4	0.8	0.0	1.7	5.8	294.6	38.1
12-Jun	22.9	13.4	2.8	0.0	1.8	7.5	306.3	39.8
13-Jun	17.7	12.0	3.0	0.0	1.2	5.0	152.1	19.3
14-Jun	19.9	12.3	6.9	0.0	2.2	7.8	264.1	35.2
15-Jun	18.7	11.2	1.7	0.0	1.6	6.4	209.5	27.2
16-Jun	18.4	10.4	2.7	0.0	1.7	6.7	234.7	31.1
17-Jun	18.2	11.0	7.1	1.5	1.5	5.7	192.1	24.3
18-Jun	19.5	11.4	4.8	0.5	2.8	12.0	282.7	36.5
19-Jun	15.8	10.2	7.0	2.5	1.9	7.8	106.2	13.3
20-Jun	16.4	10.0	5.1	0.5	1.0	4.9	161.8	20.6
21-Jun	19.5	12.4	6.3	0.0	1.5	5.0	281.3	37.1
22-Jun	20.0	14.3	8.3	0.0	1.6	5.1	260.7	35.1
23-Jun	23.2	15.8	7.2	0.0	1.7	6.4	326.9	44.1
24-Jun	25.7	15.9	5.5	0.0	1.9	7.2	315.8	42.6
25-Jun	21.6	14.9	9.6	0.0	1.1	4.7	172.2	22.8
26-Jun	22.9	15.6	8.1	0.0	0.8	3.6	178.3	24.1
27-Jun	19.7	14.9	9.4	0.0	1.3	3.7	166.3	21.8
28-Jun	20.3	15.1	11.3	0.5	1.3	5.4	153.8	20.4
29-Jun	20.3	14.5	10.9	14.2	1.5	5.5	163.0	22.6
30-Jun	20.9	14.8	10.7	5.1	1.2	4.0	176.8	23.4
1-Jul	23.1	15.6	8.4	0.0	1.5	5.1	288.2	39.8
2-Jul	22.3	15.9	10.5	0.0	1.7	6.4	233.6	32.0
3-Jul	20.0	14.6	10.9	0.0	1.5	4.2	194.9	25.8
4-Jul	21.7	15.4	10.4	0.0	1.5	4.2	251.5	33.9
5-Jul	19.1	12.6	8.9	22.4	1.1	5.4	112.6	15.4
6-Jul	21.2	13.3	6.0	0.0	1.3	4.3	243.8	33.4
7-Jul	23.1	14.2	5.4	0.0	1.4	5.2	248.7	33.5

**Table III-4-3 (continued). Daily climatic data for Eagle River Flats meteorological station during May–August 2000.**

Date	Air temp. maximum (°C)	Air temp. average (°C)	Air temp. minimum (°C)	Precipitation (mm)	Wind speed average (m/s)	Wind speed maximum (m/s)	Radiation (0.3 to 3 $\mu$ m) (W/m <sup>2</sup> )	
							Incident	Reflected
8-Jul	19.6	14.1	10.0	0.0	1.1	3.8	135.3	18.2
9-Jul	16.7	12.8	10.3	10.7	1.1	4.9	98.6	12.9
10-Jul	19.2	13.9	8.9	0.0	1.2	3.8	162.5	21.4
11-Jul	23.3	16.8	10.8	0.0	1.2	4.5	258.5	35.5
12-Jul	24.3	17.3	11.7	8.1	1.1	4.4	230.9	30.0
13-Jul	17.3	14.6	12.5	5.6	1.0	4.9	58.7	7.4
14-Jul	19.7	14.4	10.8	0.5	0.9	4.2	100.1	12.4
15-Jul	20.7	13.6	6.9	0.5	1.5	9.6	111.2	14.4
16-Jul	15.3	12.9	10.5	20.3	0.9	4.8	68.2	8.1
17-Jul	14.2	11.7	9.3	8.1	1.4	5.1	91.8	11.5
18-Jul	17.4	12.0	8.1	4.1	1.2	4.9	148.9	19.7
19-Jul	20.2	13.1	7.5	0.0	1.1	5.1	232.8	33.1
20-Jul	14.2	11.5	8.1	2.0	0.7	3.1	83.9	11.0
21-Jul	12.9	10.6	8.5	3.0	0.5	4.2	59.8	7.5
22-Jul	18.8	11.5	6.6	3.0	0.8	3.2	127.3	16.7
23-Jul	19.7	12.1	4.0	0.0	1.4	6.2	221.6	31.7
24-Jul	19.0	13.5	7.7	0.0	1.3	6.1	211.2	31.0
25-Jul	21.1	12.7	4.1	0.0	1.2	4.3	275.2	38.5
26-Jul	22.8	15.0	8.3	0.0	1.5	4.7	296.6	42.1
27-Jul	21.1	13.4	7.7	0.0	1.4	5.4	159.3	22.7
28-Jul	16.6	11.1	9.1	24.4	0.8	4.9	81.8	10.6
29-Jul	13.8	10.4	5.8	3.6	0.9	4.1	64.0	8.6
30-Jul	20.3	12.7	8.0	0.0	1.1	6.0	206.1	28.3
31-Jul	17.8	11.6	4.8	0.0	1.1	6.2	122.9	15.9
1-Aug	20.2	12.6	5.9	0.0	1.5	7.4	134.2	17.6
2-Aug	17.2	14.5	10.7	5.1	3.4	13.9	43.6	5.2
3-Aug	22.7	17.5	11.1	0.0	4.1	11.0	191.5	27.8
4-Aug	17.1	11.6	8.9	10.2	0.8	3.4	84.4	11.4
5-Aug	19.5	12.2	5.8	0.0	1.2	5.5	182.0	24.7
6-Aug	19.5	12.3	6.9	0.0	1.0	4.6	180.1	25.4
7-Aug	19.3	11.5	2.2	0.0	1.1	4.9	193.6	27.1
8-Aug	21.6	13.9	8.2	0.0	1.4	5.6	242.8	34.3
9-Aug	21.8	12.2	1.4	0.0	1.3	5.5	253.5	37.2
10-Aug	19.5	12.1	3.2	0.0	0.9	3.7	171.8	24.0
11-Aug	21.9	14.6	6.9	0.0	1.2	4.4	201.7	29.5
12-Aug	23.8	15.1	6.7	0.0	1.0	4.0	200.1	28.3
13-Aug	22.3	14.4	9.2	16.3	1.0	4.7	110.9	15.1
14-Aug	21.2	13.5	6.6	1.0	1.4	11.4	168.4	23.8

Fort Richardson, Alaska. FY99 Final Report. CRREL Contract Report to US Army, Alaska, Directorate of Public Works. July 2000, p. 97–103.

**Collins, C.M.** (1999) Weather data for Eagle River Flats. In Collins, C.M. and M.J. Hardenberg (Ed.) (1999) Interagency Expanded Site Investigation: Evaluation of White Phosphorus Contamination and Potential Treatability at Eagle River Flats, Alaska. FY98 Final Report. CRREL Contract Report

to US Army, Alaska, Directorate of Public Works. July 1999, p. 99–107.

**Haugen, R.K.** (1995) Climate and tides. In Racine, C.H. and D. Cate (Ed.) (1995) Interagency Expanded Site Investigation: Evaluation of White Phosphorus Contamination and Potential Treatability at Eagle River Flats, Alaska. FY94 Final Report. CRREL Contract Report to US Army, Alaska, Directorate of Public Works. May 1995, vol. 1, p. 187–200.

## **III-5. EAGLE RIVER FLATS WIRELESS REMOTE IMAGING SYSTEM**

**Christopher R. Williams and Gary M. Trachier**  
U.S. Army Cold Regions Research and Engineering Laboratory

### **INTRODUCTION**

A remote imaging system proved to be useful for monitoring the daily operations of the Pond Pumping Remediation Project at Eagle River Flats (ERF). By visually inspecting the daily retrieved images from the remote imaging systems, project managers could monitor the effectiveness of the pumping remediation efforts. Retrieving images from ERF proved to be difficult during the 1999 field season. We analyzed the shortcomings and designed a new robust image retrieval system from the bottom up. The new system, based on wireless technology, was deployed in two ponded areas under treatment. The retrieved images were successfully used throughout the 2000 field season to monitor the conditions of the pumping remediation efforts.

### **GOAL FOR THE 2000 FIELD SEASON**

The goal of the 2000 field season was to develop a reliable wireless remote imaging system (RIS) that could visually monitor the white phosphorus attenuation parameters of the Eagle River Flats Remediation Project. Once deployed, the RIS would remotely re-

trieve images documenting pumping operations, soil drying, tidal activity, and flooding at two pond sites (Ponds 183 and 258) on the Flats. A Web site was developed where the daily retrieved images would be archived for monitoring purposes. The Web page's URL is <http://www.crrel.usace.army.mil/erf>. At the conclusion of the 2000 field season, the performance of the RIS was thoroughly analyzed, and potential future improvements were identified.

### **EXPERIENCE WITH REMOTE IMAGING EQUIPMENT**

Remote imaging equipment used during the 1999 and 2000 field seasons was designed utilizing the AXIS 200+ Network Camera Server. The equipment that supports the AXIS 200+ is the primary difference between the systems used during the two field seasons. The 1999 design utilized a cell phone and local internet service provider (ISP) as a means of transferring images via file transfer protocols (ftp) from the Axis 200+ to the Cold Regions Research and Engineering Laboratory (CRREL) in Hanover, NH. The AXIS 200+ camera, working via a time- and event-based scripting language (cron), would capture an

image, dial the local ISP via the cell phone, and ftp the image to the ISP. The image would then be transferred to the CRREL public ftp server. Once on the public ftp server, the image would be posted to the ERF web site. Though this design works well in an urban area with reliable cell phone coverage and AC line power, it is not reliable at a remote site such as the Flats.

The equipment used during the 1999 field season is designed to be powered by 120-V AC. The only source of power at the remote site is solar. Two 75-W solar panels and a charging controller charged a bank of 12-V batteries. The batteries in turn powered a 12-V DC to 120-V AC inverter. The inverter's AC output powered the equipment. There was not enough power available from the solar panels and batteries, so the system eventually failed.

### PROPOSED SOLUTION FOR THE 2000 FIELD SEASON

To overcome the limitations of poor cell phone coverage and the lack of AC line power, it was decided that the RIS would use wireless radio technology and be powered by 12-V DC. The new approach uses off-the shelf components wherever possible, the exception being a 12-V DC to 12-V AC power inverter designed and built at CRREL. Starting with the remote site (Fig. III-5-1) and working to-

wards CRREL, the equipment that supports the AXIS 200+ is as follows.

The AXIS 200+ web camera is connected to a Black Box Corporation model RF115 radio frequency modem (RF115) via an EIA-232 interface. Solar panels, deep-cycle 12-V batteries, and a 12-V charging regulator power this equipment. The AXIS 200+ web camera and RF115 are housed in a Pelco environmental enclosure specifically designed for cameras. This package is referred to as the remote site equipment (RSE) (Fig. III-5-2, III-5-3).

Hard-wire telephone service from the military Defense Switch Network (DSN) is available at Bravo Bridge (Fig. III-5-4). A US Robotics telephone modem and RF115 modem identical to the one at the remote sites are located on the bridge. The phone modem connects to the DSN, the phone and RF115 modems are connected by an EIA-232 connection, and omni-directional antennas at both sites complete the data path.

Solar panels, a charging regulator, and deep-cycle 12-V batteries power the RF115 modem and 12-V DC to 12-V AC inverter. The inverter powers the US Robotics modem. This equipment is housed in a NEMA-rated enclosure mounted to the northern abutment on Bravo Bridge and is referred to as the base station equipment (BSE) (Fig. III-5-5, III-5-6).

Data then flow via DSN to CRREL in Hanover, NH (Fig. III-5-7). At the CRREL site, data are transferred through another US Robotics modem and finally via a Digi Interna-

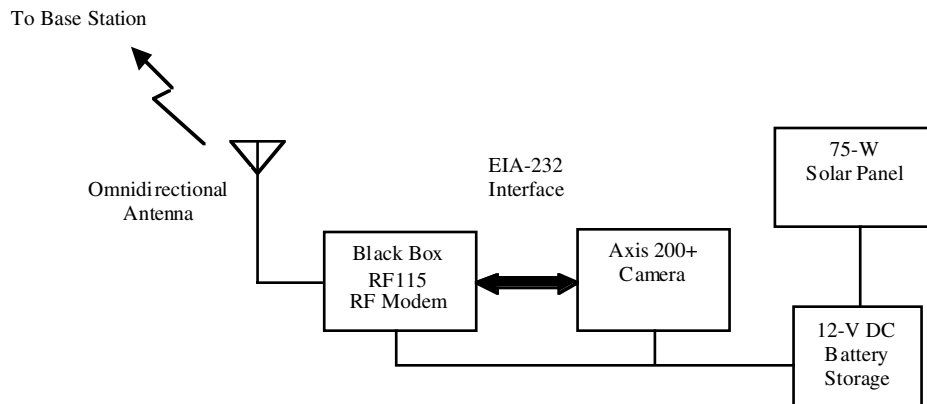

Figure III-5-1. Remote site equipment.



*Figure III-5-2. Axis 200+ camera.*



*Figure III-5-3. Placement of the remote site equipment in the field.*

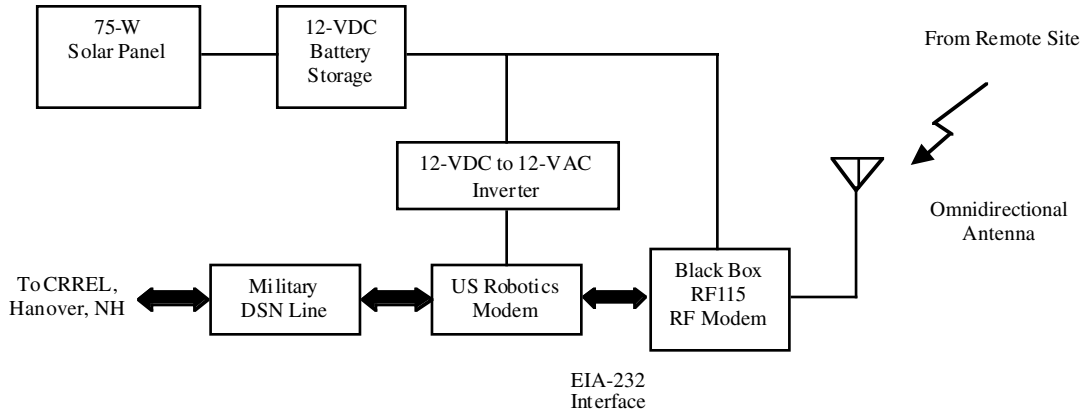

Figure III-5-4. Base station equipment.



Figure III-5-5. Base station.



Figure III-5-6. Base station antennas.

tional two-port serial interface into an Intel-based computer. The computer runs the Red Hat Linux operating system.

Script files developed at CRREL run by the Linux operating system's cron daemon are responsible for all aspects of connecting to the remote camera, transferring the images to CRREL, and posting them to the ERF Web site.

### SYSTEM PERFORMANCE

The RIS performed moderately well during the 2000 field season. The RIS was installed on 15 May 2000 and removed at the end of the field season on 15 August 2000, for a total of 97 days. During that time the RIS experienced four issues that affected its ability to retrieve images. Three of the issues dis-

abled the RIS 36 days of the 97 days, while the fourth affected the reliability of one of the remote sites. Modem failures, an incorrect baud rate setting (human error), and a solar panel misalignment at Pond 183 affected system performance. The modem that failed was the US Robotics modem at the base station located on Bravo Bridge. The modem failed twice at this location. It was decided after the second modem replacement that more protection against transient voltage spikes on the telephone line was required. A Dead Bolt surge protection device was installed between the modem and the phone line. At that time the RIS should have been up and running if it weren't for an incorrect baud rate setting.

The baud rate of the serial interface of the telephone modem that communicates with

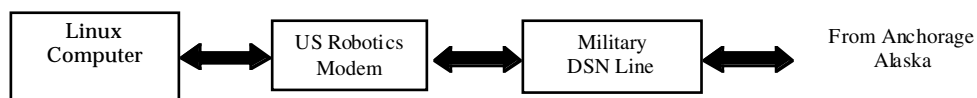

Figure III-5-7. CRREL site.



the RF115's EIA-232 port was inadvertently set wrong at CRREL. This was determined by communicating via a computer terminal emulator with the phone modem and RF115 from CRREL. CRREL personnel located at the Bravo Bridge site assisted with troubleshooting the phone modem by substituting loop-back terminators on the serial interface and cabling that connects the US Robotics modem to the RF115. Characters were transmitted from CRREL and returned from the Bravo Bridge site with the use of the loop-back terminators. Once the characters failed to return, the problem area was identified and corrected. The fourth and final issue that caused problems was a misaligned solar panel at Pond 183. That became apparent in the final two weeks of the field season as the image retrieval success rate from Pond 183 declined. The loss of images was correlated to the shifting position of the sun late in the season and the decrease in effective radiance to the fixed solar panel on the tower. No corrective measures were taken because of the lateness in the season.

### IMAGING SYSTEM SUCCESS RATE

Discounting the 36 days that the RIS was down due to telephone modem failures and an incorrect baud rate setting, the system overall performed well. Table III-5-1 shows the image retrieval success rate of the RIS with respect to image requests. A 100% image retrieval success rate was anticipated, but the success rate was actually lower. Pond 183 reported a lower image success rate than Pond 258 because of the misaligned solar panel. The inability of the solar panel to charge the batteries located at Pond 183 caused the RSE to

stop transmitting images. In addition to the solar panel issue at Pond 183, it is believed that the quality of the phone line connection was also responsible for the overall image retrieval success rates.

### FUTURE RIS IMPROVEMENTS

Three areas of improvements have been identified: image quality, power management, and solar panel alignment. During the course of the day, different light levels present at each RSE location resulted in different levels of image quality. To overcome this, it was decided to install a polarizing filter on the cameras at each RSE location.

Power management also needed to be addressed. During the 2000 field season the RIS equipment was powered 24 hours a day. This results in a very large power budget. To reduce the power used, a small microcontroller will be installed at each RSE location to turn the RSE on at the required times for image retrieval. At the conclusion of the image retrieval process, the microcontroller will turn off the power. This will dramatically lower the power budget of the RIS.

The last issue is the alignment of the solar panels. During the 2000 field season the solar panels were fixed to the sides of the wooden towers at the ERF pond sites. If the towers were positioned with one side facing south, then the solar panel alignment was correct. The alignment of the tower and solar panel at pond 183 was wrong. To improve the panel alignment, galvanized poles will be installed on each tower located at the ERF pond sites. This will allow the proper use of the solar panel mounts and orientation of the panels to the south.

### CONCLUSION

At the conclusion of the 2000 field season, it was apparent that the redesign of the remote imaging system was a success. The images that were retrieved and posted to the ERF Web site proved to be an invaluable source of

**Table III-5-1. Retrieval success rate.**

<i>Imaging System</i>	<i>Image Requests</i>	<i>Images Retrieved</i>	<i>Success Rate (%)</i>
Pond 183	578	446	77.2
Pond 258	578	505	87.4

information. The images allowed project managers to view the effects of the pumping remediation operations, the drying of soil, the tidal activity, and the flooding events at the Flats. With that information, project managers were able to make crucial decisions that

directly affected work at the Flats. It is apparent that a variety of new applications are possible with the success of the RIS. Researchers may now use the RIS to retrieve images from remote sites and disseminate them as never before.



## IV-1. EAGLE RIVER FLATS DATABASE AND ENVIRONMENTAL CHANGE MONITORING

**Charles Racine**

U.S. Army Cold Regions Research and Engineering Laboratory

### INTRODUCTION

The objectives of this ongoing effort are to:

- Maintain and update the ERF GIS database with all sediment samples obtained and analyzed for white phosphorus;
- Input the telemetry data obtained by the NWRC (National Wildlife Research Center), make maps, and conduct analyses;
- Make these map-based GIS data available to users;
- Conduct a change assessment for ERF to evaluate the effects of treatments and natural processes on wetland habitats and gully erosion; and
- Obtain new imagery and integrate it into the ERF GIS.

### RESULTS

#### **Sediment samples analyzed for white phosphorus**

We entered into the database the locations and white phosphorus concentrations for all sediment samples obtained during 2000 so that the database now includes all samples analyzed for white phosphorus from the beginning of the project in 1991 to September 2000. This includes over 3000 point samples and 300 composite samples.

During the past year the entire database

was transferred to the USARAK GIS, a large database used by the Ft. Richardson DPW environmental branch to manage contamination and clean-up efforts on the U.S. Army facilities in Alaska. The Eagle River Flats portion permits managers to obtain and view all white phosphorus concentration data for sediment samples selected either by individual sample number or by accessing all of the discreet or composite samples from any of the mapped ponds (Fig. IV-1-1). Ponds as identified and mapped into the ERF GIS originally in 1993 are the basic contamination and clean-up units on Eagle River Flats.

To identify ponds that require remediation, M.E. Walsh has extended sampling for white phosphorus contamination to ponds where no samples were obtained in the past, where insufficient samples were taken, or where there has been significant mortality based on radio-telemetry.

#### **Waterfowl studies**

During 2000 we developed a CD that contains all of the telemetry data from 1996 to 1999. In 2000 no telemetry took place. We worked with NWRC (John Cummins and Patty Pochop) to develop metadata files and summary tables for each year, as well as the GIS coverages for each duck. Of particular importance was the development of a method or model for quantifying mortality from one year to the next. Another priority use of this

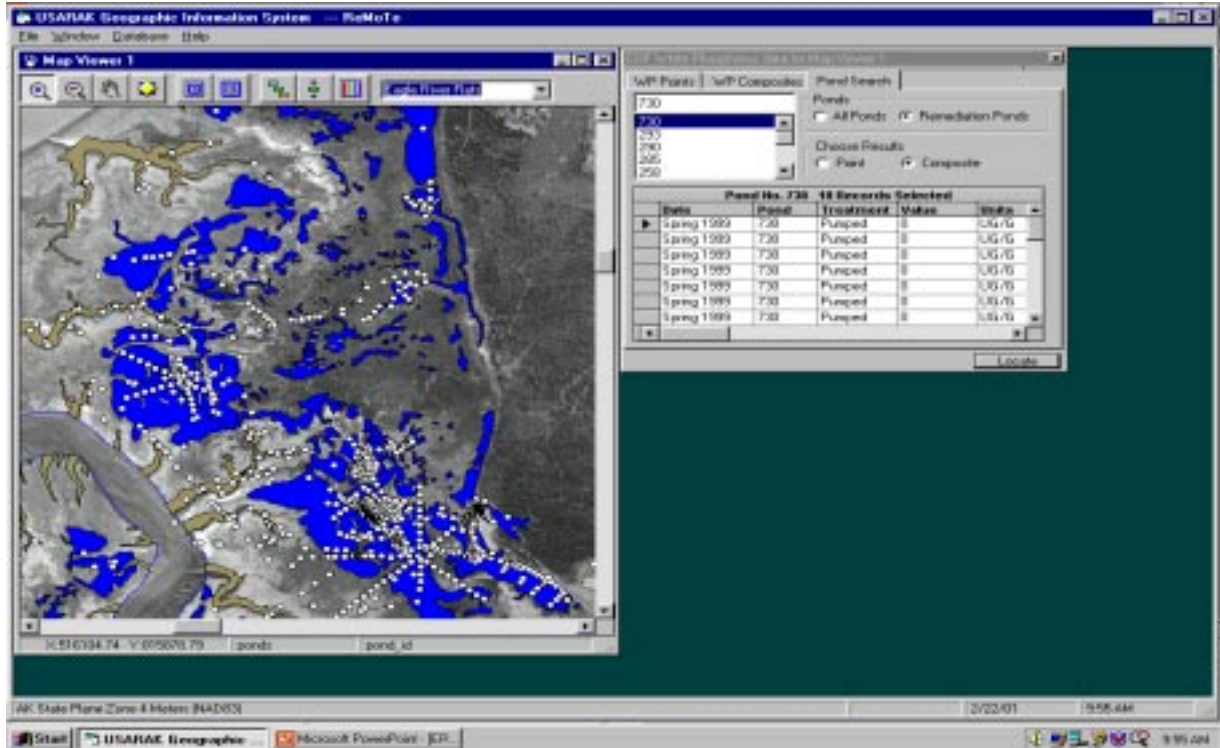

Figure IV-1-1. Example of a screen from the USARAK GIS database for contaminants showing all point and composite sediment samples analyzed for white phosphorus. The database permits the user to locate and obtain all of the point or composite samples collected and analyzed for any pond. Here the composite samples collected in pond 730 are listed. It is necessary to scroll down to see all of the samples and the concentrations.

data is to identify ponds or areas where the dead birds might have ingested white phosphorus. We compared home ranges of ducks that died with home ranges of ducks that survived using animal movement software extensions for ArcView GIS available on the Internet at <http://www.absc.usgs.gov/giba/gistools/inex.htm>.

### Gully erosion

During 2000 we produced maps to show

additional erosion of the ditch draining the Bread Truck Pond (Fig. IV-1-2)

### Remediated or treated ponds

The database also tracks contaminated ponds that have been treated for white phosphorus contamination. Attributes of these treated ponds include the methods and dates when treatments were applied. The changes in white phosphorus concentrations in these ponds can also be tracked using the database.

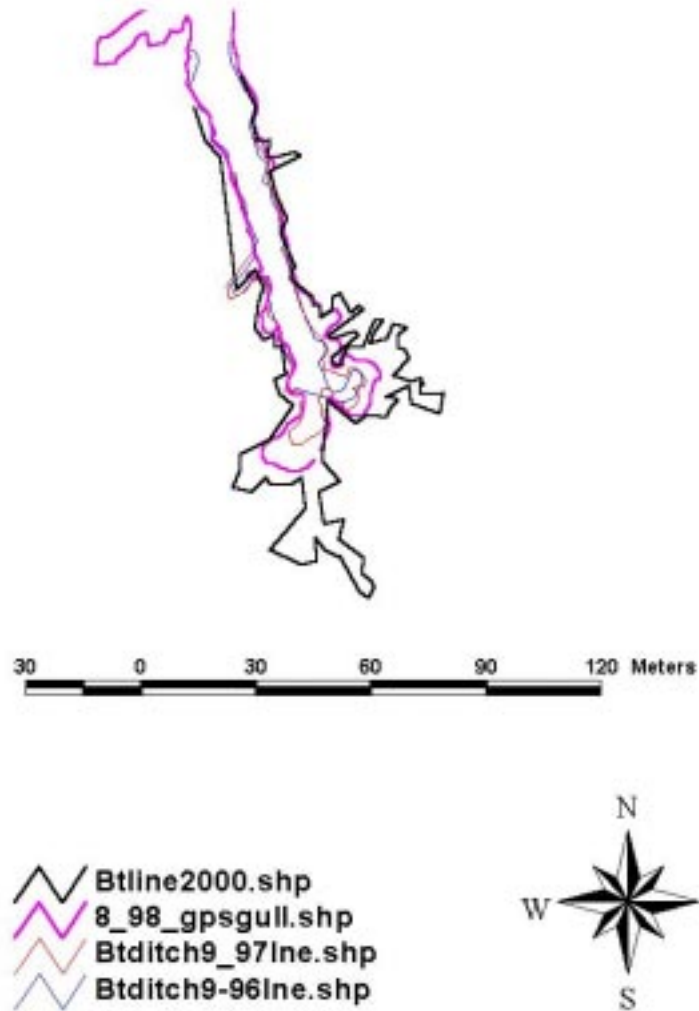
**Bread Truck Drainage Ditch Erosion 1996-2000**

Figure IV-1-2. Monitored erosion of the Bread Truck drainage ditch from 1996 to 2000 showing the edge of the deep gully as monitored by surveying or GPS.

