

Final Indoor Air Sampling Report

**297 West 5th Avenue
North Pole, Alaska**

Revised: October 07, 2022

Prepared for:

Mr. David Cornwall

Prepared by:

**Alaska Resources and
Environmental Services, LLC.**



3520 International Street
Fairbanks, AK 99701

Prepared
by:



Dustin Stahl
Environmental Specialist

Table of Contents

1.0	INTRODUCTION & PURPOSE.....	1
2.0	SITE BACKGROUND.....	1
2.1	Site Description	1
2.2	History	1
2.3	Topography.....	2
2.4	Regional Hydrology	2
3.0	Field Work Protocol.....	2
3.1	Fieldwork Activities	2
4.0	Indoor Air Analytical Sampling.....	4
4.1	Indoor Air- Analytical Results	4
5.0	Data Quality	6
6.0	Conclusions.....	6

1.0 INTRODUCTION & PURPOSE

This Indoor Air Sampling Report was prepared on behalf of Mr. David Cornwall who has contracted with Alaska Resources & Environmental Services (ARES) to perform a limited indoor air investigation at the subject property. Mr. Cornwall is the Owner of the Subject Property located at 297 West 5th Avenue. The ADEC Hazard ID for the site is 4439. The ADEC file # for the site is 100.38.216.

The purpose of this project was to conduct a limited indoor air quality assessment of the property and to determine if contaminants of concern (COCs) are present in the indoor air at the Subject Property above ADEC indoor air target levels for residential/commercial buildings.

2.0 SITE BACKGROUND

2.1 Site Description

The subject property is situated on an approximate 0.30-acre site located west of the Old Richardson Highway and north of Fifth Avenue at 297 Fifth Avenue, North Pole, Alaska (Figure 1). The site is located in the U.S. Geological Survey (USGS) Fairbanks D-1 SW quadrangle. The legal description for the property is as follows: Tax Lot 3A Block 14 B.V. Davis Homestead out of Lot 3 Block 14 B.V. Davis Homestead, Township 2 South, Range 2 East, Fairbanks Meridian.

2.2 History

Records indicate that in November 2006, a UST heating oil tank suspected of leaking was inadvertently filled. It was estimated that approximately 215 gallons of # 2 diesel fuel may have leaked from the tank before being pumped dry one week after filling. During excavation of the tank, approximately 5 gallons of fuel was recovered from the surface of the groundwater. One soil sample collected from the excavation pit indicated 9 mg/kg benzene, 65,000 mg/kg DRO, and 1,210 mg/kg GRO was present in the soil.

It was also noted that the contaminants most likely extend underneath the building which is located approximately 6' from the source area. Diesel fuel odors were detected in portions of the interior of the building and crawl space during an inspection by ADEC staff and the owner.

Subsequent corrective actions/site characterization included installation of groundwater monitoring wells, installation of an air handling system in the crawl space and most recently collection of indoor air samples from the crawl space to assess indoor air quality. Indoor air samples collected by NORTECH Environmental in March 2018 detected Isopentane and Freon 11 in the southern and northern crawlspace. Both compounds do not have an ADEC target level and are not a chemical of concern related to the fuel oil release. No other compounds were detected in the south crawlspace. The north crawlspace had additional impacts which included benzene, toluene, ethylbenzene, and xylenes below ADEC residential target levels.

The site is currently being used as a child daycare facility.

2.3 Topography

The United States Geological Survey (USGS) Fairbanks Quadrangle (D-1 SW) provides topographic map coverage of the site. North Pole is located in the northern part of the Tanana Basin, which is a relatively flat floodplain of the Tanana River. The subject property is situated approximately 1.5 miles west of the Tanana River. Based upon the topographic map of the Fairbanks Quadrangle, the site elevation is approximately 435 feet above the mean sea level.

2.4 Regional Hydrology

The Chena and Tanana rivers are the dominant influence on ground-water flow in the subject area. Two discharge peaks characterize the Chena River: spring snowmelt runoff and late summer precipitation. The stage of Chena River typically rises and falls in response to stage changes of the Tanana River. The depth to groundwater varies in response to these controlling factors. Based on interpretation of USGS data and historical data, regional groundwater flow direction is generally to the north-northwest. However, the direction of flow can vary slightly depending on the stage of the Chena River and Tanana River. Depth to groundwater in the area is generally 8-10 feet bgs, though seasonal fluctuation can range between 6-12 feet bgs.

3.0 Field Work Protocol

Fieldwork described in this report was conducted in accordance with *ADEC Vapor Intrusion Guidance for Contaminated Sites, November 2017*.

Mr. Dustin Stahl, Project Manager / Environmental Specialist for ARES performed the sampling activities for this project. Mr. Stahl meets the ADEC qualifications of Qualified Environmental Professional by the Alaska Department under 18 AAC 75.

3.1 Fieldwork Activities

Site Walk-through, Building Survey and Inventory:

Prior to sampling activities, ARES conducted a site walk-through with ADEC's Environmental Project Specialist Shawn Tisdell on October 16, 2022, to perform a building survey. During the walk through and inspection ARES completed the ADEC Building Survey and Indoor Air Sampling Questionnaire which is included in Appendix E. There were no petroleum related indoor vapor sources observed that could interfere with detecting of COCs. It was noted that the daily day care operations required frequent use of sanitizing and cleaning products that had observable odors but could not be eliminated from the environment while the daycare was in operation. The cleaning product odors were more prevalent in the north end of the building.

The following details were noted during the building inspection:

1. The facility has two heat sources. A large, forced-air wood pellet burning heater heats the south end of the building. This heater is located in the crawlspace access closet adjacent to the infant care rooms of the facility. A hydronic diesel fired boiler heats the north end of the building with base board heat. This heater has its own room and access on the east side of the building. Neither heater was in use during the investigation. The diesel boiler was not connected to a fuel source at the time of inspection. Both heat sources exhaust through chimneys that penetrate the roof of the building and likely contribute to “stack effect”
2. The recently installed air handling unit in the crawlspace was turned off during the sampling event.
3. A manometer was used to evaluate the pressure difference between the crawlspace and the main floor of the facility in the infant care room. There was virtually no difference in pressure, indicating a full communication pathway between the crawlspace and the first floor of the building.
4. The crawlspace has a dirt floor that was covered by a 10 mil Visqueen vapor barrier. The vapor barrier was attached to the concrete footer and/or cinder block walls using Tremco Acoustical Sealant. The vapor barrier had pulled away from the sealant in numerous locations.
5. The cinderblock walls of the crawlspace had noticeable cracks in several locations that would allow for vapor intrusion into the crawlspace.
6. A noticeable non-fuel odor (cleaning product?) was observed in the north end of the crawlspace
7. A Multi-RAE PPB Photoionization Detector (PID) was used to evaluate the air quality during the walkthrough. Multi-RAE readings are summarized in Table 1 below.

Table 1: Ambient Air PID Readings

Location	Multi-RAE Reading (in ppb)	Notes
Entry way of building	460	
Above crawlspace entrance	350	
In crawlspace below entrance	130	South end of crawlspace
Under Vapor Barrier-South	110	South end of crawlspace-near fuel lines
Center of crawlspace	190	Center/midpoint of crawlspace
Under Vapor Barrier- Center	140	Center/midpoint of crawlspace
North Crawlspace	280	North end of crawlspace. Non-fuel odor observed-Possible cleaning product
1 st Floor Hallway	460	
Bathroom	640	Shared wall with outside diesel boiler room. Observable cleaning product odors.

4.0 Indoor Air Analytical Sampling

Indoor air samples were collected using Radiello-130 Passive adsorption samplers and laboratory analyzed for hexane, cyclohexane, benzene, toluene, ethylbenzene, m,p-xylene, o-xylene, propylbenzene, 1,2,4-Trimethylbenzene, 1,3,5-Trimethylbenzene and naphthalene by modified EPA Method TO-17 (RAD130 Passive SE by Mod EPA TO-17).

In order for detection limits to be significantly below ADEC Indoor air target levels the Radiello-130 Passive adsorption samplers were deployed for two weeks. The samples were deployed on Friday August 19, 2020, and retrieved on Friday September 02, 2022.

A total of two (2) analytical samples, one (1) per each previously sampled crawl space area (north crawlspace and south crawlspace) were deployed, retrieved, and analyzed during the indoor air investigation.

Code 130 stainless steel net cylinders with activated charcoal were placed in diffusive body (code 120) protectors and connected to supporting plates (code 121) and deployed in each designated sampling location and retrieved after two weeks. New disposable nitrile gloves were worn during sample deployment and collection. Pens/marker with volatile ink (Sharpies) were not used to fill out sample labels.

Following collection, samples were stored and shipped in laboratory supplied sealed glass containers. A signed Chain-of-Custody form accompanied the samples to Eurofins/Air Toxics. Eurofins/Air Toxics is certified by the National Environmental Laboratory Accreditation Program (NELAP), and Department of Defense (DOD-ELAP) for air and soil-gas analysis.

Volatile organic compounds were trapped by adsorption and were be recovered by the laboratory using carbon disulfide displacement. Analysis was performed by Eurofins Air Toxics of Folsom CA by modified EPA-TO-17 method using gas chromatography/mass spectrometry. Radiello sampling and analysis protocol is included in Appendix B. HOBO UX100 Temp data logging thermometers were deployed in each sample location and recorded min, max, and average temperature data that was reported to the lab for sample analysis calculations.

4.1 Indoor Air- Analytical Results

The building is currently being used for commercial purposes. However, per the ADEC Vapor Intrusion Guidance dated November 2017, it is ADEC's policy to evaluate day care centers and schools as residential use properties because of the sensitivity of the exposed population (children). The air sample analytical results are evaluated against both ADEC Target Levels for Residential and Commercial Indoor Air in Table 2 below. For the current use of the building the Residential Indoor Air Target levels would apply.

Table 2: Indoor Air Quality -297 W 5th Ave -RAD-130-(Collected 08/18/22 to 09/02/22)

Compound (in ug/m ³)	Sample ID	Sample ID	ADEC Target Levels for Indoor Air ¹	
	Crawl Space(S) 2209156-01A	Crawl Space(N) 2209156-02A	Residential	Commercial
Hexane	0.40	1.1	730	3100
Cyclohexane	26	82	6300	26000
Benzene	0.27	0.27	3.6	16
Toluene	1.7	4.3	3800	7500
Ethylbenzene	0.64	1.5	11	49
Xylenes(total)	4.1	9.2	100	440
Propylbenzene	0.88	1.3	1000	4400
Naphthalene	0.29	0.34	0.83	3.6
1,2,4-Trimethylbenzene	8.1	13	7.3	31
1,3,5-Trimethylbenzene	2.9 C	4.1 C	NA	NA

Shade= Result exceeds ADEC Residential Target Levels for Indoor Air

Shade= Result exceeds ADEC Commercial Target Levels for Indoor Air

¹-Appendix D- ADEC Vapor Intrusion Guidance for Contaminated Sites November 2017.

C=Estimated concentration due to calculated sampling rate.

ug/m³-micrograms per cubic meter

NA-not available

Analytical Results confirm that the north and south crawlspace air during the sample interval was below ADEC commercial indoor air target levels for all tested analytes. All detected results were less than 1/10 the commercial target level with the exception of 1,2,4-Trimethylbenzene. These results would apply if the building was used for other commercial purposes (excluding daycare or school use) in the future.

Analytical Results confirm that the north and south crawlspace air during the sample interval was below ADEC residential indoor air target levels for all tested analytes with the exception of 1,2,4-Trimethylbenzene. 1,2,4-Trimethylbenzene exceeded residential target levels in the south crawlspace sample (8.1 ug/m³) and in the north crawlspace sample (13 ug/m³). These results apply to the current use of the building.

An evaluation of the observations during the site walk though indicates that Tremco acoustical sealant was used in the crawlspace to seal the vapor barrier. The vapor barrier had pulled away from the sealant in numerous locations leaving the sealant exposed. 1,2,4-Trimethylbenzene is listed as the seventh ingredient on the Tremco product specification sheet. The exposed Tremco sealant may be contributing to the detected concentrations of 1,2,4- Trimethylbenzene.

5.0 Data Quality

A stage 2 data validation review was performed on the analytical data. The sample receipt condition checks were found to be complete and in compliance with project requirements. None of the data required rejection and there were no QC errors or discrepancies that affected the quality or usability of the data.

All data quality is deemed sufficient for its intended use.

An ADEC Laboratory Checklist is included in Appendix D.

6.0 Conclusions and Recommendations

Analytical Results confirm that the north and south crawlspace air during the sample interval was below ADEC **commercial** indoor air target levels for all tested analytes. The facility's air quality meets the ADEC indoor air target levels for commercial use (excluding daycare or school use).

Analytical Results confirm that the north and south crawlspace air during the sample interval was below ADEC **residential** indoor air target levels for all tested analytes with the exception of 1,2,4-Trimethylbenzene. Per the ADEC Vapor Intrusion Guidance dated November 2017, it is ADEC's policy to evaluate day care centers and schools as residential use properties because of the sensitivity of the exposed population. The air quality of the crawlspace does not meet ADEC indoor air target levels for 1,2,4-Trimethylbenzene for residential use. The crawl space is only occasionally occupied for short durations, however there is a direct communication pathway between the crawl space and the first floor through the crawlspace access door on the south end of the building and a floor vent on the north end of the building.

The impacts of these communication pathways to the air quality on the first floor cannot be determined without additional sample collection from the first floor of the building. It should be noted that collection of an unbiased sample on the first floor may not be feasible while the daycare is in operation due to the use of deodorizers, sanitizers, and other cleaning products required for routine operation of the facility.

An evaluation of the observations noted during the site walk though indicates that Tremco acoustical sealant was used in the crawlspace to seal the vapor barrier. The vapor barrier had pulled away from the sealant in numerous locations leaving the sealant exposed. 1,2,4-Trimethylbenzene is listed as the seventh ingredient on the Tremco product specification sheet. The exposed Tremco sealant may be contributing to the detected concentrations of 1,2,4-Trimethylbenzene. If the vapor barrier was reattached in the areas of exposed Tremco it is likely that the off-gassing of 1,2,4-Trimethylbenzene from the sealant could be significantly reduced.

The analytical sample collection was performed while the crawlspace air handler was not in operation as directed by ADEC. The operation of the crawlspace air handler will affect the air

quality of the crawlspace and the air quality of the first floor. The venting of air from the crawlspace while the air handler is in operation could potentially reduce concentrations of contaminants of concern, but further evaluation of the air handler's operation, the pressure differentials in the building while it is operating, and additional analytical data would be needed to determine its specific affects on air quality throughout the building.

APPENDIX A

Photos



PHOTOGRAPH 1: VIEWED NORTH- SUBJECT PROPERTY- SOUTH SIDE



PHOTOGRAPH 2: VIEWED NORTHEAST SUBJECT PROPERTY- WEST SIDE



PHOTOGRAPH 3: VIEWED NORTH- SUBJECT PROPERTY EAST SIDE- BOILER ACCESS DOOR IN MIDDLE



PHOTOGRAPH 4: VIEWED WEST- BOILER ROOM AND DIESEL FIRED BOILER



PHOTOGRAPH 5: VIEWED SOUTHEAST- CRAWL SPACE BELOW ACCESS HATCH



PHOTOGRAPH 6: VIEWED EAST- ABANDONED FUEL LINES IN CRAWL SPACE & PID SREENING BELOW VAPOR BARRIER

INDOOR AIR SAMPLING
297 WEST 5TH AVENUE, NORTH POLE, AK

PHOTOGRAPHS 1-6

**Alaska Resources and
Environmental Services, LLC**
3520 International Street, AK 99701

PH. (907) 374-3226
FAX (907) 374-3219



APPENDIX B

Radiello Sampling and Analysis Protocol



radiello®

Manual

Centro di Ricerche Ambientali - Padova

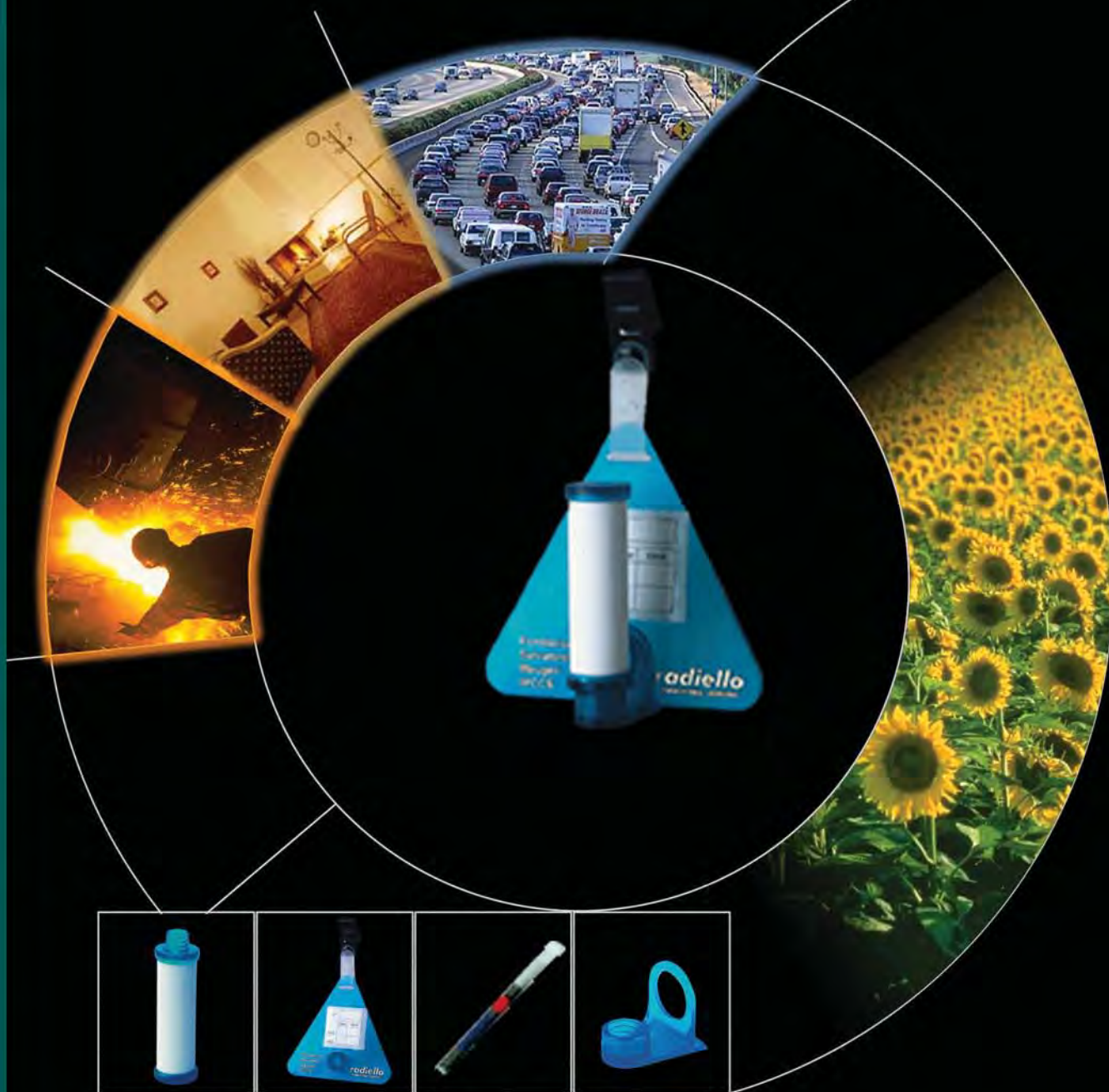

S SUPELCO
www.sigma-aldrich.com/radiello

SIGMA-ALDRICH



Index

	Page
how does the diffusive sampler work?	A1
why is radiello so special?	A3
the components of radiello	A5
the adsorbing cartridge	A5
the diffusive body	A5
the supporting plate	A5
the label	A5
how to use radiello	A6
before sampling: assembling the supporting plate	A6
on-field: to start the sampling	A6
after the sampling	A7
radiello maintenance	A7
radiello -ready-to-use	A8
accessories for radiello	B1
vertical adapter	B1
shelter	B1
how to assemble the shelter	B2
on-field temperature measurements	B3
calibration solution for H ₂ S	B4
filtration kit	B4
calibration solutions for aldehydes	B4
calibration solutions for BTEX (CS ₂ desorption)	B5
calibration solutions for VOCs in workplace environments	B5
calibration solutions for BTEX (thermal desorption)	B6
the spare parts of radiello	B6
empty cartridge	B6
barcode adhesive label	B6
clip	B6
tube	B6
strip	B6
radiello applications	
aldehydes	C1
volatile organic compounds (VOCs) chemically desorbed with CS ₂	D1
volatile organic compounds (VOCs) thermally desorbed	E1
nitrogen and sulfur dioxides (NO ₂ and SO ₂)	F1
ozone (O ₃)	G1
hydrogen sulfide (H ₂ S)	H1
ammonia (NH ₃)	I1
hydrochloric acid (HCl)	J1
hydrofluoric acid (HF)	K1
anaesthetic gases and vapours	L1
phenol, methylphenol and dimethylphenol (thermally desorbed)	M1
index by code	Z1
index by subject	Z2

how does the diffusive sampler work?

The diffusive sampler is a closed box, usually cylindrical. Of its two opposite sides, one is "transparent" to gaseous molecules which cross it, and are adsorbed onto the second side. The former side is named diffusive surface, the latter is the adsorbing surface (marked with **S** and **A** in the figure).

Driven by the concentration gradient dC/dl , the gaseous molecules cross **S** and diffuse towards **A** along the path **l**, parallel to the axis of the cylindrical box. The molecules, which can be trapped by the adsorbing material, are eventually adsorbed onto **A** according to the equation:

$$\frac{dm}{dt} = D S \frac{dC}{dl} \quad [1]$$

where dm is the adsorbed mass during time dt and D is the diffusion coefficient.

Let C be the concentration at the diffusive surface and C_0 the concentration at the adsorbing surface, the integral of [1] becomes

$$\frac{m}{t} = D \frac{S}{l} (C - C_0) \quad [2]$$

If the concentration at the adsorbing surface is negligible, the equation can be approximated to

$$\frac{m}{t C} = D \frac{S}{l} = Q \quad \text{and then} \quad C = \frac{m}{t Q} \quad [3]$$

Q is the **sampling rate** and has the dimensions of a gaseous flow (if m is expressed in μg , t in minutes and C in $\mu\text{g}\cdot\text{l}^{-1}$, Q is expressed in $\text{l}\cdot\text{min}^{-1}$).

Therefore, if Q is constant and measured, to calculate the ambient air concentration you need only to quantify the mass of analyte trapped by the adsorbing material and to keep note of the time of exposure of the diffusive sampler.

To improve the analytical sensitivity the collected mass m should be increased by enlarging Q . As D is a constant term, one can only try to improve the S/l ratio, namely the **geometrical constant** of the sampler. Unfortunately, in the common axial symmetry sampler, if S is enlarged, the adsorbing surface **A** must be enlarged too, in order to keep the two parallel surfaces at a fixed distance. Since the analytes can be recovered from the axial sampler only by solvent extraction, any increase of **A** lead to a proportional increase of the extraction solvent volume, thus the improvement of Q is canceled out by the effect of dilution.

The value of distance l could also be reduced, but under the critical value of about 8 mm the diffusion law is no longer valid in the case of low air velocity values, since adsorption rate becomes higher than supplying rate of analyte molecules at the diffusive surface.

Cannot we improve Q then?

The answer is to improve the sampler geometry to a **radial** design.

From this idea the **radiello** sampler has been developed, its cylindrical outer surface acting as diffusive membrane: the gaseous molecules move axially parallel towards an adsorbent bed which is cylindrical too and coaxial to the diffusive surface.

When compared to the axial sampler, **radiello** shows a much higher diffusive surface without increase of the adsorbing material amount. Even if the adsorbing surface is quite smaller then the diffusive one, each point of the diffusive layer faces the diffusion barrier at the same distance.

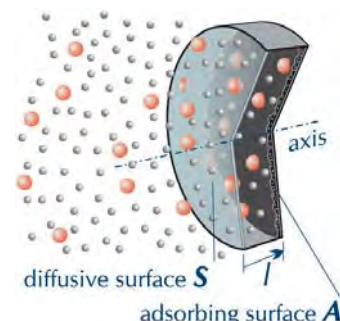

In the diffusive sampler, the adsorbing and the diffusive surfaces are two opposing plane of a closed box. Driven by the concentration gradient, the gaseous molecules (coloured in the figure) pass through the diffusive surface and are trapped from the adsorbing surface.

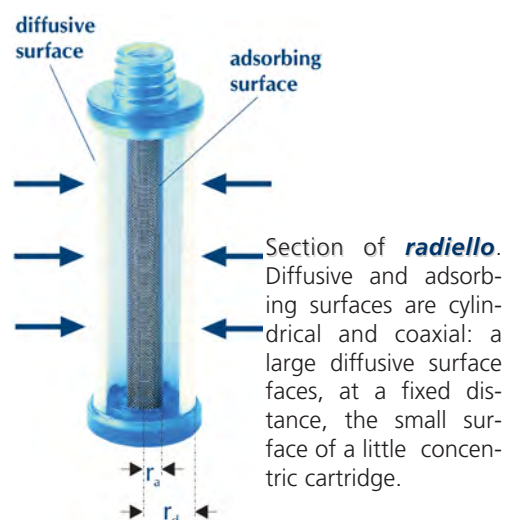



As $S=2\pi rh$ (where h is the height of the cylinder) and the diffusive path is as long as the radius r , we can then express equation [1] as follows

$$\frac{dm}{dt} = D 2\pi h r \frac{dC}{dr} \quad [4]$$

The integral of equation [4] from r_d (radius of the diffusive cylindrical surface) to r_a (radius of the adsorbing surface) becomes

$$\frac{m}{t C} = D \frac{2\pi h}{\ln \frac{r_d}{r_a}} = Q \quad [5]$$

the ratio

$$\frac{2\pi h}{\ln \frac{r_d}{r_a}}$$

is the geometrical constant of **radiello**. The calculated uptake rate [5] is therefore proportional to the height of the diffusive cylinder and inversely proportional to the logarithm of the ratio of diffusive vs adsorbing cylinder radii.

The microporous sintered polyethylene diffusive barrier of **radiello** photographed at the electron microscope; the path length is much longer than the membrane thickness due to the tortuosity of the pores.



While r_a can be easily measured, r_d can only be calculated by exposure experiments. Actually the diffusive membrane has been designed with a thick tubular microporous layer. The actual diffusive path length is therefore much longer than the distance among the diffusive and adsorbing surfaces due to the tortuosity of the path through the pores. A diffusive cylinder of external diameter 8 mm, thickness 1.7 mm and average porosity of 25 μm , coupled to an adsorbing cartridge with radius 2.9 mm creates a diffusive path of 18 mm instead of the straight line path estimation of $(8-2.9) = 5.1$ mm.

The sampling rate Q is function of diffusive coefficient D , which is a thermodynamic property of each chemical substance. D varies with temperature (T) and pressure (p); therefore also the sampling rate is a function of those variables according to

$$Q = f(T, p)$$

Q values that will be quoted in the following have been measured at 25 °C and 1013 hPa. As a consequence, they should be corrected so as to reflect the actual sampling conditions.

The correction of Q for atmospheric pressure is usually negligible since its dependence is linear and very seldom we face variations of more than 30 hPa about the average value of 1013 hPa. In the worst case, if corrections for pressure are ignored you make an error of $\pm 3\%$, usually it is within $\pm 1.5\%$.

On the other hand, Q depends exponentially on temperature variations, therefore more relevant errors can be introduced if average temperature is significantly different from 25 °C. Moreover, when chemiadsorbing cartridge are used kinetic effects (variations of reaction velocities between analyte and chemiadsorbing substrate) can be evident, apart from thermodynamic ones (variation of D).

It is therefore very important to know the average temperature in order to ensure accuracy of experimental data. See how you can perform on-field temperature measurements on page B3.

Even if some cartridges adsorb large quantities of water when exposed for a long time in wet atmosphere, generally this does not affect sampling by **radiello**. Some consequences, nevertheless, can sometimes be felt on the analysis. As an example, a very wet graphitised charcoal cartridge could generate ice plugs during cryogenic focusing of thermally desorbed compounds or blow out a FID flame.

It is therefore important to protect **radiello from bad weather. See page B1 how this can be easily done.**



why is radiello so special?

The diffusive sampling does not involve the use of heavy and encumbering pumping systems, does not have energy power supply problems, does not require supervision, is noiseless, is not flammable and does not represent an explosion hazard, can be performed by everybody everywhere and with very low costs.

Moreover, it is not subject to the breakthrough problem, which can be serious when active pumping is performed.

In pumped sampling the adsorbed compound behaves as a chromatographic peak (top): air flow displaces it along the adsorbent bed and its concentration is distributed as a gaussian function. Eventually, the compound comes out from the opposite end. When its concentration in the outlet air is 10% of the concentration in the sampled air we say that the **breakthrough** has been reached or, with a misleading expression, that the tube has been saturated. Any further pumping leads to a loss of analyte and a consequent underestimation of the environmental concentration. The extent of this phenomenon depends weakly on the concentration of target compound but rather on the value of air flow, the overall sampling volume and the chemical compound involved.

In the graph the case of benzene is displayed, sampled at 25 °C onto an activated charcoal adsorbent bed of the same volume of a code 130 **radiello** cartridge. The breakthrough is reached after 35, 44 or 49 liters of sampled air depending on benzene concentration in air (10, 50 or 100 $\mu\text{g}\cdot\text{m}^{-3}$ respectively).

An apparently similar phenomenon is shown by **radiello** also. In this case, however, we cannot speak of breakthrough, since no actual air flow is involved, but rather of **backdiffusion**. This consists of a decrease of the value of $m\cdot Q^{-1}\cdot t^{-1}$ (which is equal to the measured concentration, see eqn. [3] on page A1). This term is constant and equal to the actual concentration until the adsorbed mass of analyte is far from the maximum amount allowed by the adsorbing medium capacity. The extent of backdiffusion depends on concentration and exposure time but a decrease of 10% in the $m\cdot Q^{-1}\cdot t^{-1}$ term is observed along with equivalent sampling volumes of magnitude bigger than those seen before: 1600, 2300 and 3050 liters at the concentration of 10, 50 and 100 $\mu\text{g}\cdot\text{m}^{-3}$.

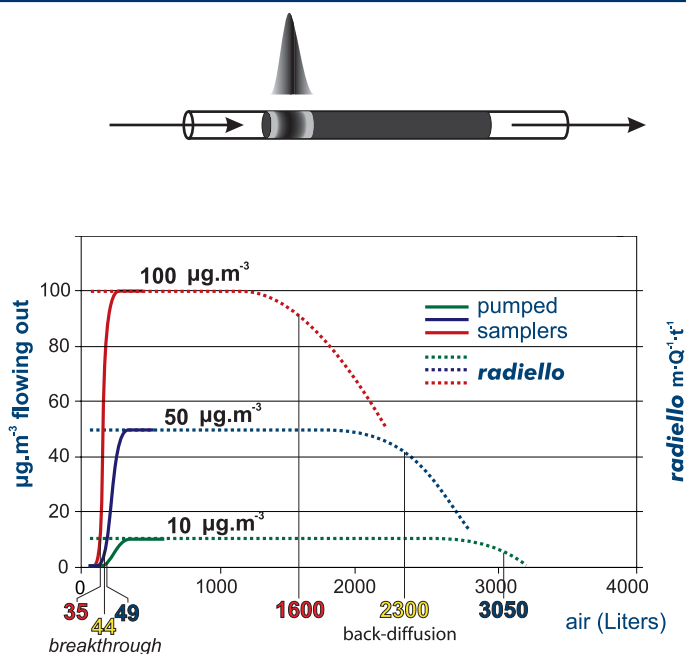

Why diffusive sampling has not been so extensively adopted up to now?

This is due to the fact that the traditional axial symmetry sampler has generally poor sensitivity and reproducibility because of the limits set by its geometry. On one side, uptake rate values are generally low, on the other, they often vary depending on environmental conditions.

These limitations have been overcome by **radiello**.

By virtue of radial symmetry, uptake rate is:

- ✓ **high**, since it does not vary linearly but exponentially with the ratio diffusive surface vs diffusive path length (see eqn. [5]). With the same dimensions, radiello's uptake rate is at least three times higher than that of any axial diffusive sampler;

For a traditional axial symmetry sampler the uptake rate

increases linearly with the ratio of diffusive surface vs diffusive path length, while for the radial symmetry sampler, the corresponding increase is exponential. This means that, let the diffusive surface vs diffusive path length ratio be 8:1, for the axial sampler the uptake rate value is 8 (regardless of dimensions) while for the radial one it is 45.

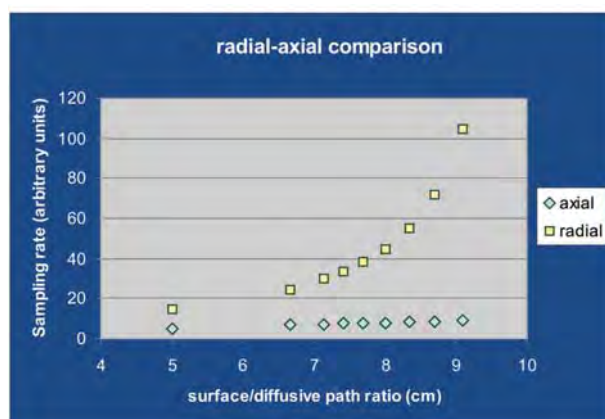



- ✓ **constant**, due to the great adsorbing capacity of the adsorbing cartridge;
- ✓ **reproducible**, by virtue of the stiffness of the diffusive membrane and the cartridge and of the close tolerances characterizing all the components of **radiello**;
- ✓ **invariable with air speed**, due to the tortuosity of the diffusive path inside the microporous diffusive cylindrical surface;
- ✓ **precisely measured**, because it is not calculated but experimentally measured in a controlled atmosphere chamber in a wide range of concentration, temperature, relative humidity, air speed conditions and with or without interferences...



Moreover, **radiello**

- ▶ able to work properly also with bad weather conditions due to the water-repellent diffusive body
- ▶ has blank values lower than three times the instrumental noise due to the complex conditioning procedures of the bulk adsorbing (or chemiadsorbing) materials and to the repeated quality controls along the whole production
- ▶ has low detection limits and high adsorbing capacities that allow exposure time duration from 15 minutes to 30 days and concentration measurements from 1 ppb to over 1000 ppm
- ▶ offers high precision and accuracy over a wide range of exposure values

- ▶ allows thermal desorption and HRGC-MS analysis without interferences
- ▶ is suited to the sampling of a vast range of gaseous pollutants
- ▶ is tough and chemically inert, being made of polycarbonate, microporous polyethylene and stainless steel
- ▶ is indefinitely reusable in all of its components apart from the adsorbing cartridge; the latter can be recovered if thermal desorption is employed
- ▶ it comes from the efforts of one of the main European scientific research institutions that produces it directly by high technology equipment and continuously submits it to severe tests and performs research and development in its laboratory in Padova



All the images in the manual concern the Environmental Research Center of Padova of the Fondazione Salvatore Maugeri-IRCCS



the components of radiello

The essential parts of **radiello** are the adsorbing cartridge, the diffusive body, the supporting plate and the adhesive label with the bar code indication. Apart from the adsorbing cartridge, if not differently stated, all of the other components can be repeatedly used for several sampling experiments.

The adsorbing cartridge

Depending on the polluting compound to be sampled, many different adsorbing or chemiadsorbing cartridges have been developed. Their dimensions are nevertheless the same for all: 60 mm length and 4.8 or 5.8 mm diameter.

They are contained in glass or plastic tubes wrapped up in a transparent polyethylene thermowelded bag.

The code number, printed onto the bag along with the lot number and expiry date indicates the kind of cartridge.

Apart from the thermal desorption cartridges, all of the other kinds are for single use only. See the application section at the back for codes relevant to the different analytes.

Available in 20 pieces per package.

The cartridge has to be introduced into the diffusive body.



The supporting plate

It is identified by the **code 121**. Made of polycarbonate, it acts both as closure and support for the diffusive body, which has to be screwed onto the thread. It comes along with a clip and a transparent adhesive pocket to hold the label. The three parts are to be assembled before use (see page A6).

Available in 20 pieces per package.



code 121

The diffusive body

Four kinds of diffusive bodies are available, with like outer dimensions: 60 mm height and 16 mm diameter.

The **white** diffusive body, **code 120**, of general use, is made of microporous polyethylene 1.7 mm thick and average porosity $25 \pm 5 \mu\text{m}$. Diffusive path length is 18 mm.

The **blue** diffusive body, **code 120-1**, has the same properties of the white one but is opaque to light: it is suited to the sampling of light-sensitive compounds.

The **yellow** diffusive body, **code 120-2**, should be used whenever the sampling rate must be reduced; it is made of microporous polyethylene 5 mm thick and average porosity $10 \pm 2 \mu\text{m}$. Diffusive path length is 150 mm.

The **permeative** diffusive body, **code 120-3**, is a $50 \mu\text{m}$ thick silicone membrane strengthened by a stainless steel net and a microporous polyethylene cylinder. It is employed for anaesthetic gases and vapours sampling.

Available in 20 pieces per package.

The diffusive body has to be screwed onto the supporting plate.



code 120

120-1

120-2

120-3



code 190

The label

Self-adhesive, with printed barcode number. Since each barcode number has been printed in only one copy, it allows an unmistakable identification of the sampling tube on field and in the laboratory for the subsequent analysis.

Each package of 20 adsorbing cartridges contains also 21 labels.

If the labels are ordered separately, they are shipped in 198 pieces per package.



how to use radiello before sampling

Before using **radiello**, you have to assemble the supporting plate with the clip, necessary to suspend it, and the adhesive label pocket.

assembling the supporting plate



1 insert the clip strip in the slot, with the peg facing upwards



2 ply the strip and insert the peg into the hole



3 peel off the transparent pocket

user tip
Assemble the supporting plate in your laboratory before the sampling campaign to save time in the field

and place it onto the plate in a central position; if you prefer, the pocket can be applied to the rear of the plate, but **BE CAREFUL**, always with the label insertion slot on the side (otherwise, if it starts raining the label can get wet)



on-field to start the sampling

open the plastic bag, draw the cartridge out from the tube and put it in the diffusive body. **Keep the glass or the plastic tube and stopper in the original plastic bag.**

The lower part of the diffusive body holds a seat for the central positioning of the cartridge. **A correctly centered cartridge should not stick out even by half a millimeter. If it does, the cartridge is not correctly positioned and out of axis.**

BE CAREFUL: do not hold the diffusive body horizontally when you screw it onto the plate, otherwise the cartridge could come out from its seat and stick out.

As a consequence, when the diffusive body is screwed onto the supporting plate the cartridge is bent, the geometry of the sampler is disturbed and the results obtained become unreliable. **To place the cartridge centrally you need only to tap on the diffusive body.**

Insert a label in the pocket without peeling it off. Keep note of the date and time and expose **radiello**. Sampling has started.

user tip
Do not touch the cartridge with your fingers if possible, particularly if it is impregnated with reactive



1



2

Keeping the diffusive body in a vertical position, to screw it onto the support plate



3



user tip

even if you can write date and time of the sampling start and end on the adhesive label, we suggest you to keep note of these parameters also separately: after a week exposure with bad weather conditions, your writing might have become illegible!

DO NOT USE MARKER PENS to write on the label: they contain solvents that are sampled by **radiello**!

after the sampling

Keep note of the date and time of the end of exposure.

Place the cartridge into the tube, peel off the label and stick it onto the tube **such that the barcode is parallel to the axis of the tube.**

If you have performed the sampling of different polluting compounds at the same time, **BE CAREFUL NOT TO MIX UP THE TUBES**: place the exposed cartridge in its original tube, identified by the code printed on the plastic bag.



IMPORTANT

Always stick the label such that the barcode is parallel to the axis of the tube: any other position will compromise the barcode automated reading by the optic reading device.

radiello maintenance

When exposed outdoors or in a workplace environment, the diffusive body may get dirty from airborne dust. Fine particles (PM₁₀) are especially harmful to yellow diffusive bodies since they can obstruct the pores. When the diffusive bodies are dirty you can wash them as follows.

Immerse the diffusive bodies in a beaker with a soapy solution (e.g. dish detergent) and sonicate them for 20 minutes. As the diffusive bodies float, you may make them sink by putting a smaller beaker on them, with water inside enough to dip it a few centimeters. Rinse the diffusive bodies with plenty of water and then deionized water; let them finally dry in the air.

IMPORTANT: NEVER USE SOLVENTS TO CLEAN THE DIFFUSIVE BODIES!!!

After four or five washings, diffusive bodies need to be replaced: repeatedly adsorbed dust may have penetrated the so deeply that they cannot be removed by washing anymore.

The following table shows the advised washing schedule:

PM ₁₀ concentration (µg·m ⁻³)	<30	40	>50
Washing after days of exposure	45	30	15



radiello-ready-to-use

The ready-to-use version may be advantageous when you prefer not to assemble all of the components on field. It can be purchased as it is or in separate parts to be assembled by the customer.

In the **ready-to-use version** the adsorbing cartridge is already contained in a diffusive body closed with a polycarbonate screw-thread cap. The whole is closed in a polypropylene airtight container. Just before use draw the diffusive body out of the container and fit it to the special snapping vertical adapter fixed to the supporting plate. After the end of exposure, the diffusive body with its content is placed again in the polypropylene airtight container to be shipped to the laboratory for analysis. The **ready-to-use radiello** (polycarbonate cap, glass or plastic tube, special snapping vertical adapter, barcode label and polypropylene container) is available for the sampling of the following compounds:

code	sampling of	contains
123-1	BTEX and VOCs	white diffusive body and cartridge code 130
123-2	BTEX and VOCs	yellow diffusive body and cartridge code 145
123-3	NO ₂ , SO ₂ and HF	blue diffusive body and cartridge code 166
123-4	aldehydes	blue diffusive body and cartridge code 165
123-5	ozone	blue diffusive body and cartridge code 172
123-6	hydrogen sulfide	white diffusive body and cartridge code 170
123-7	ammonia	blue diffusive body and cartridge code 168
123-8	HCl	white diffusive body and cartridge code 169

IMPORTANT: for the **ready-to-use** version **the supporting plate needs to be ordered separately. The ready-to-use samplers are stable for 3 months.**

If you prefer **to assemble it by yourselves**, you should order:

- ✓ diffusive bodies (of the required type, see following chapters)
- ✓ adsorbing cartridges (of the required type, see following chapters)
- ✓ polycarbonate caps, **code 124-1**
- ✓ special snapping adapters, **code 122-1**
- ✓ polypropylene containers, **code 124-2**
- ✓ supporting plates, **code 121**



on top:
to the right, radiello-ready-to-use
to the left, the diffusive body with the polycarbonate cap and the adsorbing cartridge inside

at the bottom: the special snapping adapter

see left: the supporting plate with the vertical snapping adapter

user tip

the **ready-to-use** version of **radiello** is very useful in the workplace sampling campaigns but is not advised if very low concentrations in outdoor or domestic environments are to be measured

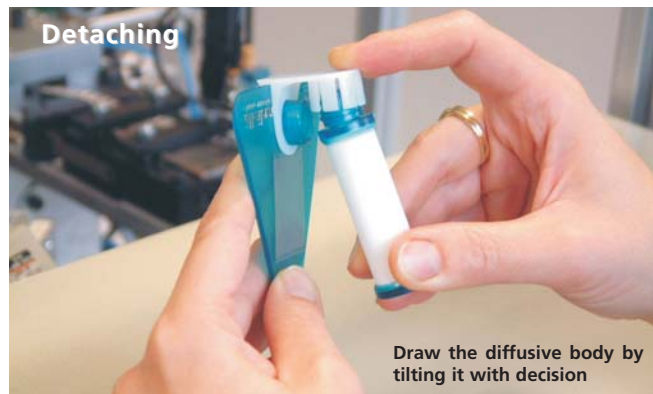



accessories for radiello

vertical adapter

code 122

The diffusive body can be fitted to the supporting plate either in a vertical or horizontal position, the vertical one being more comfortable when **radiello** is used for personal sampling.

To assemble **radiello** in vertical position you have to screw it to the **vertical adapter code 122**, fitted to the supporting plate.

Available in 20 pieces per package



Assembling the vertical Adapter

place the vertical adapter over the mounting point on the plate



The adapter can be removed from the plate by lifting the ridge

press the adapter onto the plate with your thumbs till the ridge fits the edge of the plate.



IMPORTANT
when mounting the diffusive body be careful to keep it vertical with the thread upside (see page A6).

shelter

code 196

For outdoor exposures a mountable polypropylene shelter is available which can be hung from lamp posts.

It has been designed to be mounted easily and without any tools on field, so that it is not cumbersome when you transport it from your laboratory. Once assembled, it ensures the best compromise between protection against bad weather and ventilation.

It can house up to four **radiello** and is able to fit a wide range of pole diameters.

Its colour is quite similar to that of the majority of lampposts: being less visible, it is less subject to acts of vandalism.

Available in 10 pieces per package





how to assemble the shelter

All of the components are snap-on assembled.

1
First of all, insert on this panel (the roof) the two supports that will be used to suspend the samplers.

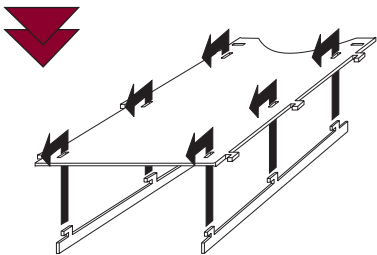

One of the three equivalent panels will act as the roof of the shelter (dimensions in mm)

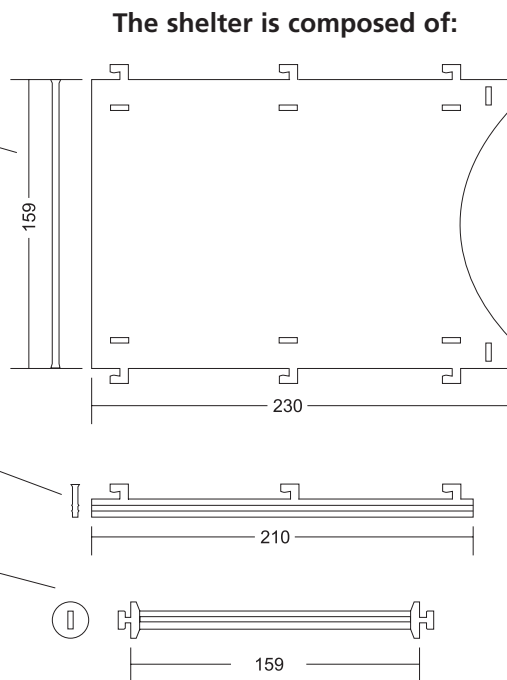

the two supports where to suspend **radiello**

two spacers

two strips shown below left

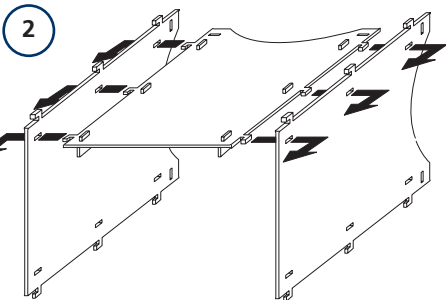

Then fix the two walls on the sides of the roof panel.

The whole becomes rigid by insertion of the two spacers. Fit them to the slots on bottom of the side panels and turn them by 90° (performing this rotation you may feel some resistance, but go on until you hear a clicking sound).

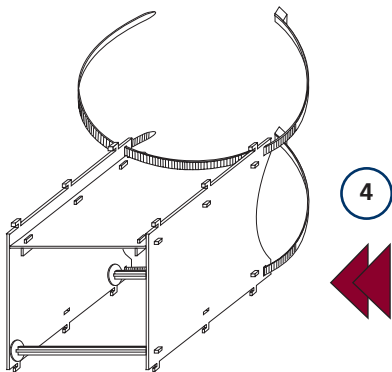
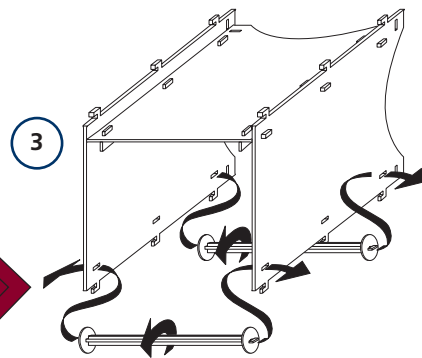

Finally, insert two plastic strips in the rear vertical slots of the side panels. The **strips** are also available as spare parts, in 100 pieces per package, identified by the **code 198**.

Suspend the shelter to the pole by closure of the strips, but **DO NOT DRAW SO MUCH THAT THE SHELTER IS DEFORMED**. If the pole has diameter larger than 20 cm, the shelter leans on the curved edges on the rear of the side-walls. If the pole has a smaller diameter, it leans against the curved edge of the roof panel and the rear spacer. If the diameter of the pole is very small the shelter bows down, the wind may make it go round, or the shelter may even slip down to ground. It is then advisable to choose another pole.

user tip

If the pole diameter is larger than the strip length, you can put two or more strips together to extend the fastening system. If the sampling site is very windy, do not introduce more than two **radiello** samplers in each shelter, otherwise rain could dampen the outermost samplers.





On-field temperature measurements

codes 126 e 127

Since the uptake rate values of **radiello** depend on temperature, the concentration values obtained will be more accurate if precise temperature measurements are performed during the sampling.

To get reliable temperature data you may ask the local weather station, if there is one, and if the measurements are performed nearby your sampling sites. Bear in mind that you should take into account the urban heat island: did you know that there can be a difference of even 4-5 °C between the center and the suburbs of a big town?

With **radiello** you can create your own temperature measurement station.

A **thermometer** with precision $\pm 0,5$ °C between -20 and 80 °C and equipped with a data logger capable of recording 2048 data points has been fixed to a vertical adapter (**code 126; 126-1 for ready-to-use sampler**). It is tiny enough (< 1 cm³) to go perfectly unobserved.

It has no battery to replace, needs no maintenance and works properly even with bad weather conditions.

Its memory allows you to record one temperature value every 15 minutes for 22 days, or every 30 minutes for 43 days, or every 60 minutes for 85 days, or... it lasts ten years or a million readings!

The thermometer is fitted to the supporting plate of **radiello**: use the sampler normally and measure temperature and pollution at the same time.

A very simple **reader** (**code 127**), connected to your PC by a serial port, allows you to program the temperature sensor for the measurements on field, to download the acquired data and to perform data statistical and graphic processing by a very user-friendly software.

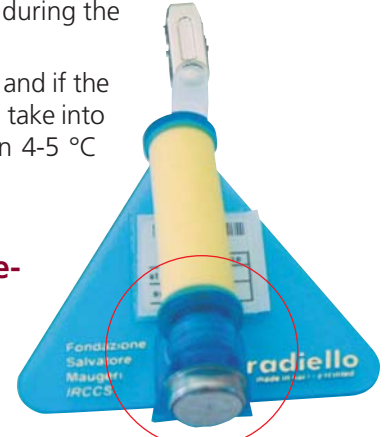

thermometer - code 126
Available as pk. of 3



reader with serial port adapter - code 127

user tip

When performing urban monitoring install a thermometer every ten sampling sites. If this may help you, contact us to discuss sampling strategies.

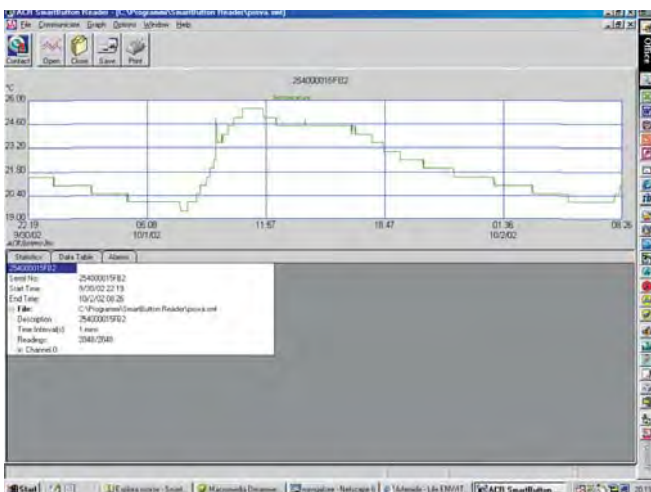



filtration kit

code 174

Code 174 filtration kit is composed by 20 single use plastic syringes and 20 single use micropore hydrophilic polypropylene filters with diameter 13 mm and 0.45 μm porosity.

Both filter and syringe are suited to filtration of aqueous solutions with pH in the range of 0 to 12 with commonplace eluents for ion chromatography and reverse phase HPLC.

calibration solution for H_2S

code 171

Code 171 relieves you from the task of preparing the sodium sulfide standard solution for the calibration curve used for the determination of H_2S by the cartridge code 170 (see page H1).

Since sodium sulfide is deliquescent, its weight is not a primary standard and sodium sulfide solution need titration once prepared. Moreover, titration must be repeated often due to the instability of diluted solution (one hour time is sufficient to decrease sulfide content by 10%).

Code 171 is a methylene blue concentrated solution that, once diluted 1:50, provides the same absorbance value at 665 nm of a sodium sulfide solution of with concentration $1.145 \mu\text{g}\cdot\text{ml}^{-1}$ sulfide ions.

This concentration value has been chosen to obtain the highest absorbance value within the linearity range of the spectrophotometer.

To obtain a complete calibration curve, just dilute the mother solution as shown in the table.

Solution	ml of	ml of water	equivalent to $\mu\text{g}\cdot\text{ml}^{-1}$ of S^{2-}
A	2 of code 171	98	1.145
B	25 of A	25	0.572
C	10 of A	40	0.229
D	5 of A	45	0.115

Code 171 contains 100mL solution that allows you to prepare as many as 50 calibration curves.

Kept closed at room temperature, code 171 solution is stable for at least one year.

calibration solution for aldehydes

code 302

Calibration curves for aldehydes are obtained with standard solutions of the corresponding 2,4-dinitrophenylhydrazones (see page C1). Although their synthesis is straightforward, their purification is tricky and time-consuming. Code 302 offers a certified and convenient choice: a solution of nine 2,4-dinitrophenylhydrazones in a solvent compatible with HPLC eluents and with concentrations suitable for the preparation of calibration curves in the range usually spanned by **radiello** samples.

Code 302 is delivered as 10 ml of acetonitrile solution of the nine 2,4-dinitrophenylhydrazones formed by the aldehydes listed in the table, contained in a pierceable-septum crimped cap vial. The listed concentration values are indicative, actual ones are certified for each lot.

Kept tightly capped in a dark place at 4 °C, the solution is stable for at least four months.

2,4-DNPH of	$\mu\text{g}\cdot\text{ml}^{-1}$ as aldehyde
formaldehyde	50
acetaldehyde	50
acrolein	10
propanal	50
butanal	50
isopentanal	50
pentanal	50
hexanal	50
benzaldehyde	50



calibration kit for BTEX (CS₂ desorption)

code 405

Code 405 calibration kit has been conceived for the analysis of BTEX sampled in urban environments by the cartridge code 130 and chemically desorbed by carbon disulfide (see page D1).

The kit may be used both for routine calibration and for scheduled quality control of the calibration procedure described on page D4.

It is composed of 12 code 130 cartridges, three of which are blanks and nine, divided into three groups of three, preloaded with BTEX to simulate 7 days exposures (10,080 minutes) to the concentrations listed in the table. The values shown are indicative, actual ones are certified for each lot.

The mass of each analyte deposited onto the cartridge spans the whole range of concentrations usually found in urban environments, extreme values included.

BTEX loading is performed by injection of precisely known amounts of vaporized standard solutions in CS₂ of the five compounds under nitrogen flow.

Kept at 4 °C, the cartridges are stable for at least four months.

code 405	simulated concentrations in $\mu\text{g}\cdot\text{m}^{-3}$ (7 days exposure equivalent)		
	Group 1	Group 2	Group 3
benzene	1	10	50
toluene	2	20	100
ethylbenzene	1	10	50
m-xylene	1	10	50
p-xylene	1	10	50
o-xylene	1	10	50

calibration kit for VOCs in workplace environments

code 406

The code 406 kit has been conceived for scheduled quality control of the calibration procedure for the analysis of volatile organic compounds (VOCs) sampled by code 130 cartridges in workplace environments (see page D4).

It is composed of 12 code 130 cartridges, three of which are blanks and nine, divided into three groups of three, preloaded with VOCs to simulate 8 hours exposures (480 minutes) to the concentrations listed in the table. The values shown are indicative, actual ones are certified for each lot.

The composition of the mixture is simple but it includes compounds with different polarity. The loaded mass is calculated in order to represent exposures to 0.5, 1 and 2 times the TLV value for the mixture.

VOCs loading is performed by injection of precisely known amounts of calibrated mixtures of the eight compounds under nitrogen flow.

Kept at 4 °C, the cartridges are stable for at least four months.

code 406	simulated concentrations in $\text{mg}\cdot\text{m}^{-3}$ (8 hours exposure equivalent)		
	Group 1	Group 2	Group 3
benzene	0.1	0.2	0.4
toluene	19	38	76
ethylbenzene	12	24	48
m-xylene	12	24	48
p-xylene	12	24	48
o-xylene	12	24	48
butanol	15	30	60
2-etoxyethyl acetate	2.5	5	10



calibration kits for BTEX (thermal desorption)

code 407	simulated concentrations in $\mu\text{g}\cdot\text{m}^{-3}$ (7 days exposure equivalent)		
	Group 1	Group 2	Group 3
benzene	1	5	25
toluene	2	10	50
ethylbenzene	1	5	25
m-xylene	1	5	25
p-xylene	1	5	25
o-xylene	1	5	25

code 407

Code 407 calibration kit has been conceived for the analysis of BTEX sampled in urban environments by the cartridge code 145 and thermally desorbed (see page E1).

The kit may be used both for routine calibration and for scheduled quality control of the calibration procedure described on page E5.

It is composed of 12 code 145 cartridges, three of which are blanks and nine, divided into three groups of three, preloaded with BTEX to simulate 7 days exposures (10,080 minutes) to the concentrations listed in the table. The values shown are indicative, actual ones are certified for each lot.

BTEX loading is performed by injection of precisely known amounts of vaporized standard solutions in methanol of the five compounds under nitrogen flow. During the analysis the chromatographic peak of methanol will be visible. Kept at 4 °C, the cartridges are stable for at least four months.

the spare parts of radiello

Empty cartridge

Can be loaded by the customer with the desired adsorbent. It is delivered with the two end caps and the glass tube.

Available in 20 pieces per package.

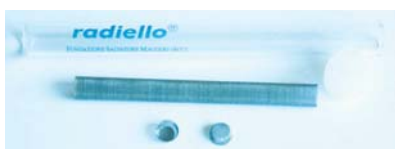

code 175
stainless steel net,
100 mesh,
5.9 mm diameter



code 176
stainless steel net,
100 mesh,
4.8 mm diameter



code 177
stainless steel net,
3x8 μm ,
4.8 mm diameter

Strip Code 198

Useful for repositioning of radiello shelter.
Length 75 cm.

Available in 100 pieces per package.



Barcode adhesive label

Code 190
Available in 198 pieces per package.

Clip

Code 195
Available in 20 pieces per package.



Tubes

Available in 20 pieces per package.



code 199-1
glass tube,
working volume
2.8 ml



code 199-2
polypropylene
tube, working
volume 12 ml



Aldehydes

Radiello components to be used:

blue diffusive body code 120-1

supporting plate code 121

vertical adapter code 122 (optional)

chemiadsorbing cartridge code 165

filtration kit code 174 (only for analysis)

Or: *radiello-ready-to-use sampler* code 123-4 (also see page A8)

Principle

Code 165 is a stainless steel net cartridge filled with 2,4-dinitrophenylhydrazine (2,4-DNPH) coated Florisil®. Aldehydes react with 2,4-DNPH to give the corresponding 2,4-dinitrophenylhydrazones

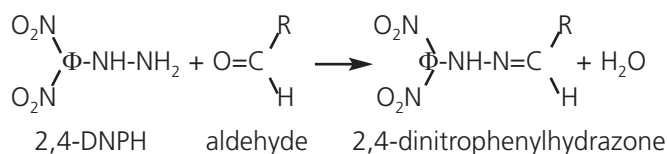

The 2,4-dinitrophenylhydrazones are then extracted with acetonitrile and analyzed by reverse phase HPLC and UV detection.

Sampling rates

Sampling rates values Q at 298 K (25 °C) and 1013 hPa are listed below:

	Q ₂₉₈ rate ml·min ⁻¹	linearity range µg·m ⁻³ ·min	limit of quantitation ¹ µg·m ⁻³	uncertainty at 2σ %
acetaldehyde	84	1,000÷12,000,000	0.1	15.9
acrolein	33	3,000÷3,000,000	0.3	16.5
benzaldehyde	92	1,000÷8,000,000	0.1	17.2
butanal	11	9,000÷10,000,000	0.9	23.5
hexanal	18	5,000÷15,000,000	0.6	20.2
formaldehyde	99	1,000÷4,000,000	0.1	13.8
glutaric aldehyde	90	1,000÷3,000,000	0.1	14.5
isopentanal	61	1,500÷12,000,000	0.2	17.0
pentanal	27	4,000÷12,000,000	0.4	22.9
propanal	39	3,000÷8,000,000	0.3	17.1

¹after 7 days exposure

Effect of temperature, humidity and wind speed

Sampling rate varies from the value at 298 K on the effect of temperature (in Kelvin) as expressed by the following equation

$$Q_K = Q_{298} \left(\frac{K}{298} \right)^{0.35}$$

where Q_K is the sampling rate at the temperature K and Q₂₉₈ is the reference value at 298 K. This produces a variation of ± 1% for 10 °C variation (upwards or downwards) from 25 °C.

Sampling rate is invariant with humidity in the range 15-90% and with wind speed between 0.1 and 10 m·s⁻¹.



Calculations

The average concentration **C** over the whole sampling time (in $\mu\text{g}\cdot\text{m}^{-3}$) is calculated according to the expression:

$$C [\mu\text{g}\cdot\text{m}^{-3}] = \frac{m [\mu\text{g}]}{Q [\text{ml}\cdot\text{min}^{-1}] \cdot t [\text{min}]} \cdot 1,000,000$$

where:

m = mass of aldehyde in μg

t = exposure time in minutes

Exposure

The optimum exposure duration varies with the expected concentration. Taking formaldehyde as an example, concentration values of $5\text{-}30 \mu\text{g}\cdot\text{m}^{-3}$ are usually found in outdoor urban measurements while $20\text{-}200 \mu\text{g}\cdot\text{m}^{-3}$ are expected in workplace environments. In workplace environments concentrations may be as high as $2,000\text{-}3,000 \mu\text{g}\cdot\text{m}^{-3}$ for short time intervals: it can therefore be interesting to evaluate the peak value (usually referred to by **STEL**). The corresponding advised exposure time is shown in the table below:

Advised exposure times

	outdoor environment	indoor environment	workplace environment average conc.	workplace environment peak conc.
minimum	8 h	8 h	2 h	15 minutes
maximum	7 days	7 days	8 h	1 h

Do not expose all of the cartridges belonging to the same lot: keep at least two cartridges as blanks.

Storage

The cartridges need to be kept in a dark place at 4°C . Closed in their bags, they are stable at least six months from the production date. Each cartridge has a blank value of formaldehyde less than $0.1 \mu\text{g}$, corresponding to a concentration in air less than $0.1 \mu\text{g}\cdot\text{m}^{-3}$ over one week of exposure or $2 \mu\text{g}\cdot\text{m}^{-3}$ over 8 hours. The blank value may increase with time. The expiry date (printed onto the plastic bag) indicates when the expected content of formaldehyde (for a correctly stored cartridge) will probably exceed $0.2 \mu\text{g}$.

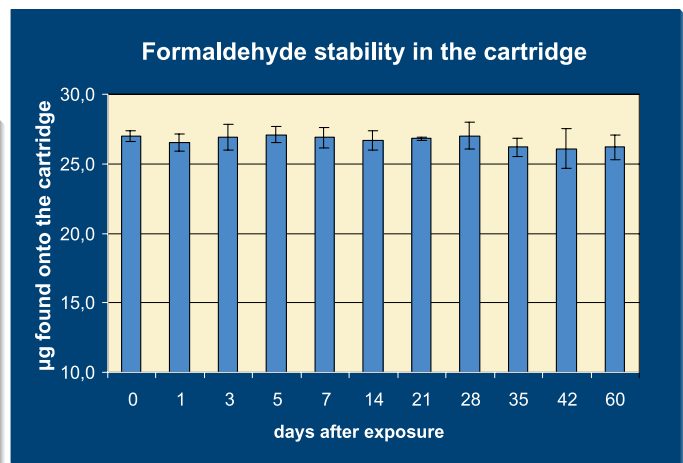
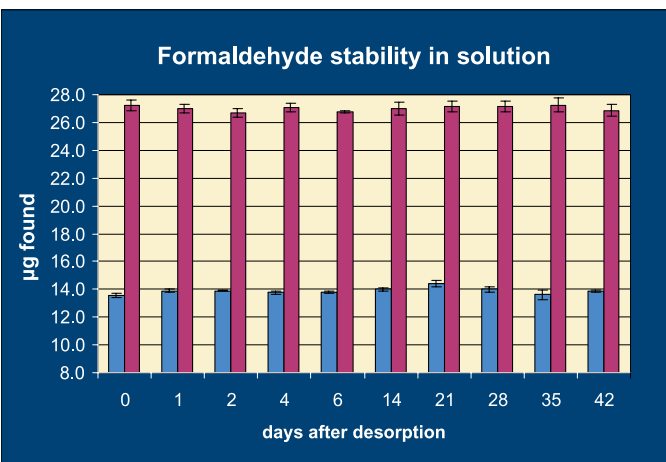

Formaldehyde stability in the cartridge after the sampling (on top) and in solution (left). The stability tests were performed upon cartridges exposed for one week in a standard atmosphere chamber at 25°C and with 50% relative humidity and at two different concentration levels. Each bar in the plot represents the average and error from the analysis of six samples.



After exposure keep the cartridges well capped at 4 °C, they are stable for 60 days. After solvent desorption (see Analysis) and extraction of the cartridge from the tube, the resulting solution, well capped and stored at 4 °C, is stable for at least 42 days (see on page C2).

Analysis

Desorption

Materials

- HPLC or spectroscopy grade acetonitrile
- class A volumetric pipette, capacity 2 ml
- micropore filter membranes, porosity 0.45 µm, solvent resistant

Procedure

Introduce 2 ml acetonitrile directly in the cartridge tube, recap and stir from time to time for 30 minutes. Discard the cartridge. Filter the resulting solution and keep it well capped until analysis time. If analysis has to be delayed, store the solution at 4 °C.

Instrumental analysis

The method suggested below is only indicative; the analyst can choose an alternative method, on the basis of its personal experience.

Materials

- reverse phase C₁₈ HPLC column, length 150 mm, 4.6 mm diameter, 5 µm packing particle size (e.g. Ascentis C18, Supelco cat.no. 581324-U)
- HPLC apparatus capable of elution gradient and UV detection

Procedure

Set the detector at the wavelength of 365 nm. Inject between 10 and 50 µl of solution and elute as follow:

- flow: 1.9 ml·min⁻¹
- Isocratic elution with acetonitrile/water 38:62 v/v for 10 minutes, up to acetonitrile/water 75:25 v/v in 10 minutes, reverse gradient to acetonitrile/water 38:62 v/v in 5 minutes.

On the right: the chromatogram of a real sample analyzed under the described conditions.

USER TIP

For extracting the cartridges use SPECTRANAL Acetonitril Fluka Cat. No. **34921** with low aldehyde content.

For a reliable and rapid filtration employ the filtration kit **code 174**.

To obtain an accurate calibration curve we offer you the calibration solution **code 302**.

IMPORTANT: verify the presence and the abundance of the 2,4-DNPH chromatographic peak: otherwise, the cartridge could be saturated.

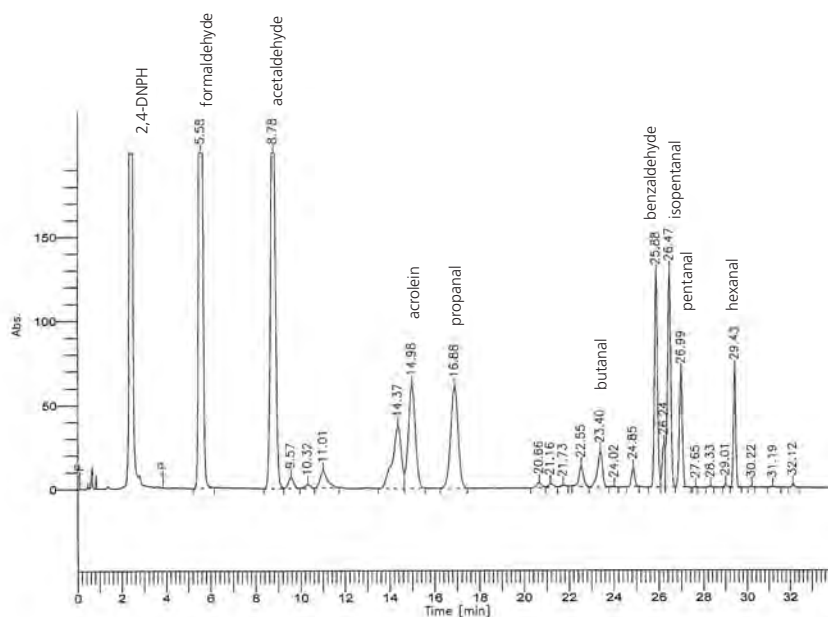

HPLC chromatogram of aldehydes sampled by radiello

IMPORTANT

Acrolein gives place to three chromatographic peaks, two of them are unresolved. Calculate the concentration basing onto this most abundant peak and ignore the others.

Isopentanal appears as two unresolved peaks: its concentration should be obtained by integration of both peaks as a sum.



USER TIP

If you perform several analyses, a barcode reader will greatly improve productivity in your laboratory and will also minimize the possibility of errors in the copying of sample labels.

Please contact us to help you in the implementation of the reader.

We have also developed software solutions for the analytical data processing and automated production of analysis reports.

Interferences

Other carbonyl compounds

All carbonyl compounds, ketones included, react with 2,4-DNPH but do not interfere in the analysis if proper chromatographic parameters are selected. In the described chromatographic conditions acetone-2,4-DNPH peak is well resolved from acrolein-2,4-DNPH. Nevertheless, if acetone concentration is higher than $50,000 \mu\text{g}\cdot\text{m}^{-3}$, acrolein-2,4-DNPH peak intensity is depressed by 25%.

Ozone

Examples of ozonolysis of dinitrophenylhydrazones on active supporting materials as silica gel are found in the literature.

On code 165 cartridge, packed with coated Florisil®, ozonolysis is much less important than on any other commercial aldehyde sampling device, either diffusive or pumped, and becomes appreciable only if ozone concentration, averaged over the whole exposure time interval, is higher than 100 ppb. Since this is not usually the case, generally no correction is needed to take into account ozone concentration. If there is firm evidence that ozone concentration is equal or higher than 100 ppb over the whole exposure time, make use of the corrected sampling rate values shown in the table below, where $[\text{O}_3]$ is ozone concentration in ppb.

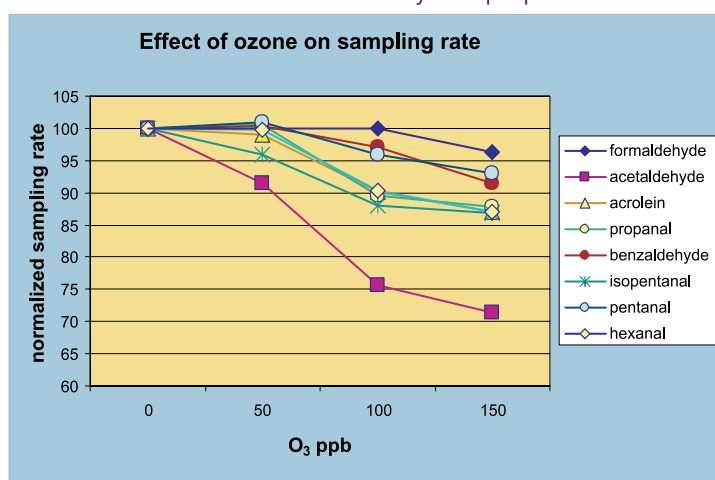

Sampling rate as a function of ozone concentration normalized to 100 for $[\text{O}_3]$ equal to zero. Apart from acetaldehyde, ozone effect becomes relevant only at concentration levels higher than 100 ppb as an average over the whole exposure time interval.

analyte	corrected sampling rate $Q_{298} \text{ ml}\cdot\text{min}^{-1}$
acetaldehyde	$84 - 0.018[\text{O}_3]^*$
acrolein	$33 - 0.027[\text{O}_3]$
benzaldehyde	$92 - 0.05[\text{O}_3]$
formaldehyde	$99 - 0.02[\text{O}_3]$
hexanal	$18 - 0.02[\text{O}_3]$
isopentanal	$61 - 0.06[\text{O}_3]$
pentanal	$27 - 0.01[\text{O}_3]$
propanal	$39 - 0.03[\text{O}_3]$

*apply for ozone concentration higher than 50 ppb

The listed values are referred to the temperature of 298 K (25 °C), for deviations larger than ± 10 °C substitute the base value (e.g. $99 \text{ ml}\cdot\text{min}^{-1}$ for formaldehyde) with the corrected value calculated according to equation on page C1.

No experimental data is available for butanal and glutaric aldehyde.

Sampling rate for ozone concentration $[\text{O}_3]$ in ppb (apply only if $[\text{O}_3] > 100$; for acetaldehyde $[\text{O}_3] > 50 \text{ ppb}$)



Volatile organic compounds (VOCs) chemically desorbed with CS₂

Radiello components to be used:

White diffusive body code 120

Supporting plate code 121

Vertical adapter code 122 (optional)

Adsorbing cartridge code 130

Or: *radiello-ready-to-use* code 123-1 (also see page A8)

Principle

Code 130 cartridge is a stainless steel net cylinder, with 100 mesh grid opening and 5.8 mm diameter, packed with 530 ± 30 mg of activated charcoal with particle size 35-50 mesh. Volatile organic compounds are trapped by adsorption and recovered by carbon disulfide displacement, analysis is performed by FID gas chromatography.

Sampling rates

The table on page D2 lists sampling rate values at 298 K (25 °C) and 1013 hPa, experimentally measured in a standard atmosphere chamber. For other compounds, whose diffusion coefficient¹ is known, sampling rate can be calculated according to equation [5] on page A2, taking into account that white diffusive body and code 130 cartridge give the geometric constant of radiello the value of 14.145 ± 0.110 cm. Several experiments performed in the standard atmosphere chamber demonstrate that the calculated sampling rates seldom deviate by more than ± 10% from the experimentally measured values.

Effect of temperature, humidity and wind speed

Sampling rates varies from the value at 298 K on the effect of temperature (in Kelvin) as expressed by the following equation

$$Q_K = Q_{298} \left(\frac{K}{298} \right)^{1.5}$$

where Q_K is the sampling rate at the temperature K and Q_{298} is the reference value at 298 K. This produces a variation of ± 5% for 10 °C variation (upwards or downwards) from 25 °C.

Sampling rate is invariant with humidity in the range 15-90% and with wind speed between 0.1 and 10 m·s⁻¹.

¹Lugg G.A.: Diffusion Coefficients of Some Organic and Other Vapours in Air. *Anal. Chem.* **40-7**:1072-1077 (1968).

Calculations

The listed sampling rate values already take into account for the desorption efficiency with carbon disulfide. **The average concentration over the exposure time interval is therefore calculated from the mass of analyte found onto the cartridge and exposure time without introducing any corrective factor**, apart from corrections due to average temperature different from 25 °C.

Average concentration over the whole exposure time is calculated according to the following expression

$$C [\mu\text{g}\cdot\text{m}^{-3}] = \frac{m [\mu\text{g}]}{Q_K [\text{ml}\cdot\text{min}^{-1}] \cdot t [\text{min}]} \cdot 1,000,000$$

where:

m = mass of analyte in μg

t = exposure time in minutes



Sampling rate values Q at 25°C (298 K)

	Q ₂₉₈ ml·min ⁻¹	linearity range µg·m ⁻³ ·min	uncertainty at 2σ %	notes
acetone	77	10,000-600·10 ⁶	7.0	a
acetonitrile	73	10,000-6·10 ⁶	8.2	b
acrylonitrile	75	1,000-50·10 ⁶	2.2	
benzyl alcohol	37	1,000-800·10 ⁶	6.5	
amyl acetate	52	1,000-800·10 ⁶	3.4	
benzene	80	500-500·10 ⁶	1.8	
bromochloromethane	70	50,000-1,000·10 ⁶	1.4	
butanol	74	1,000-500·10 ⁶	5.0	
sec-butanol	64	1,000-300·10 ⁶	5.2	
tert-butanol	62	1,000-300·10 ⁶	5.5	
butyl acetate	60	1,000-1,000·10 ⁶	3.0	
2-butoxyethanol	56	1,000-100·10 ⁶	5.7	
2-butoxyethyl acetate	41	1,000-100·10 ⁶	5.5	
carbon tetrachloride	67	100,000-60·10 ⁶	9.0	
cyclohexane	54	500-500·10 ⁶	4.5	
cyclohexanone	68	5,000-120·10 ⁶	4.2	
cyclohexanol	54	5,000-120·10 ⁶	4.5	
chlorobenzene	68	1,000-1,000·10 ⁶	3.6	
chloroform	75	100,000-60·10 ⁶	9.7	a
n-decane	43	500-1,000·10 ⁶	1.1	
diacetone alcohol	43	500-1,000·10 ⁶	4.5	
1,4-dichlorobenzene	51	1,000-1,000·10 ⁶	7.7	
1,2-dichloroethane	77	1,000-500·10 ⁶	8.2	
1,2-dichloropropane	66	500-250·10 ⁶	4.5	
dichloromethane	90	500-60·10 ⁶	8.7	
N,N-dimethylformamide	82	1,000-200·10 ⁶	14.5	c
1,4-dioxane	68	1,000-600·10 ⁶	5.5	
n-dodecane	8	1,000-1,000·10 ⁶	4.7	
n-heptane	58	5,000-1,500·10 ⁶	3.0	
n-hexane	66	1,000-1,000·10 ⁶	2.5	
1-hexanol	52	5,000-120·10 ⁶	5.5	
ethanol	102	10,000-500·10 ⁶	7.5	a-b
diethyl ether	78	5,000-500·10 ⁶	12.0	a
ethyl acetate	78	1,000-1,000·10 ⁶	1.5	
ethylbenzene	68	1,000-1,000·10 ⁶	2.4	
2-ethyl-1-hexanol	43	5,000-500·10 ⁶	10.1	
2-ethoxyethanol	55	500-50·10 ⁶	6.7	b
2-ethoxyethyl acetate	54	10,000-100·10 ⁶	2.5	
ethyl-tert-butyl ether (ETBE)	61	500-200·10 ⁶	3.0	
isobutanol	77	1,000-300·10 ⁶	2.5	
isobutyl acetate	63	1,000-1,000·10 ⁶	5.2	
isooctane	55	500-1,000·10 ⁶	3.2	
isopropanol	52	10,000-400·10 ⁶	12.0	b
isopropyl acetate	66	1,000-1,000·10 ⁶	9.9	
isopropylbenzene	58	1,000-1,000·10 ⁶	2.7	
limonene	43	1,000-1,000·10 ⁶	10.0	
methanol	125	10,000-250·10 ⁶	9.2	a-b
methyl acetate	80	1,000-1,000·10 ⁶	12.0	
methyl-ter-butyl ether (MTBE)	65	500-200·10 ⁶	2.5	



	Q ₂₉₈ ml·min ⁻¹	linearity range µg·m ⁻³ ·min	uncertainty at 2σ %	notes
methylcyclohexane	66	1,000-1,000·10 ⁶	6.5	
methylcyclopentane	70	1,000-1,000·10 ⁶	2.5	
methylethylketone	79	1,000-500·10 ⁶	1.6	
methylisobutylketone	67	1,000-250·10 ⁶	8.7	
methyl metacrylate	68	1,000-500·10 ⁶	2.5	
2-methylpentane	70	1,000-1,000·10 ⁶	2.5	
3-methylpentane	70	1,000-1,000·10 ⁶	2.5	
2-methoxyethanol	35	5,000-100·10 ⁶	11.0	b
2-methoxyethyl acetate	56	2,000-100·10 ⁶	3.0	
1-methoxy-2-propanol	55	1,000-350·10 ⁶	6.0	
1-methoxy-2-propyl acetate	60	2,000-350·10 ⁶	6.2	
naphthalene	25	1,000-1,000·10 ⁶	7.0	
n-nonane	48	1,000-1,000·10 ⁶	5.4	
n-octane	53	500-1,000·10 ⁶	3.2	
pentane	74	1,000-1,000·10 ⁶	1.9	
α-pinene	53	1,000-1,000·10 ⁶	7.0	
propyl acetate	65	500-1,000·10 ⁶	7.5	
propylbenzene	57	1,000-1,000·10 ⁶	2.9	
styrene	61	1,000-500·10 ⁶	3.0	
tetrachloroethylene	59	10,000-500·10 ⁶	2.5	
tetrahydrofuran	74	2,000-250·10 ⁶	11.0	b
toluene	74	500-1,000·10 ⁶	1.5	
1,1,1-trichloroethane	62	5,000-1,000·10 ⁶	5.5	
trichloroethylene	69	5,000-1,000·10 ⁶	2.4	
1,2,4-trimethylbenzene	50	500-1,000·10 ⁶	6.6	
n-undecane	24	1,000-1,000·10 ⁶	10.0	
m-xylene	70	500-1,000·10 ⁶	2.5	
o-xylene	65	500-1,000·10 ⁶	2.5	
p-xylene	70	500-1,000·10 ⁶	2.5	

Notes:

- a** = weakly adsorbed compound. If its concentration is higher than the TLV for the workplace environments it may be partially displaced by other compounds that are more strongly trapped if their concentration is also high. If this is the case, it is advisable to reduce sampling time under 8 hours.
- b** = prolonged exposure of charcoal cartridges at relative average humidity higher than 80% causes adsorption of up to 100 mg of water. Water does not interfere with adsorption mechanisms but is displaced by carbon disulfide and gives rise to a separate layer. Some very water soluble polar compounds will distribute between the two solvents, thus provoking an underestimation of the actual air concentration since only the carbon disulfide is injected in the gas chromatograph. When the concentration of polar compounds has to be determined, the calibration curve should be prepared by spiking 50 µl of water in each tube containing the cartridge and the 2 ml of carbon disulfide standard solution (see Analysis).
- c** = better reproducibility obtained by use of methanol as extraction solvent instead of carbon disulfide.

Limit of quantitation

The limit of quantitation depends on the instrumentation and on the analytical conditions. The minimum revealable environmental concentration can be estimated on the basis of the equation on page D1, where *m* is the minimum revealable mass, experimentally measured for each compound. Under the analytical conditions described on page D4, the limit of quantitation for 7 days exposure usually ranges from 0.05 to 1 µg·m⁻³, depending on the compound.



Exposure

Code 130 cartridge has a very large loading capacity: about 80 mg, corresponding to an overall VOCs concentration of 3,000-3,500 mg·m⁻³ sampled for 8 hours or 70,000-80,000 µg·m⁻³ sampled for 14 days. Nevertheless, if the quantified overall adsorbed mass should be near 80 mg, sampling rate could have deviated from linearity. If this is the case, it is advisable to repeat the sampling experiment reducing exposure time.

Workplace environment

In workplace environments complex mixtures of airborne solvent vapours are often found at concentrations of 2,000-3,000 mg·m⁻³. The outstanding adsorbing capacity of code 130 cartridges allows you to sample them for the whole working shift of 8 hours. On the other hand, the very high values of sampling rates for a variety of compounds allow you to perform accurate concentration measurements even after very short exposures. For example, 15 minutes are enough to measure 0.1 mg·m⁻³ of benzene.

radiello can therefore be employed to evaluate both *TWA* and *STEL* concentrations.

Other indoor sampling experiments and outdoor campaigns

High sampling rates of **radiello** ensure very low limits of detection also for short exposure time intervals. For example, you may measure benzene concentrations as low as 2 µg·m⁻³ with an error not exceeding 4% after 8 hours of exposure. If **radiello** is exposed for 7 days, limit of quantitation becomes 0.1 µg·m⁻³.

Generally speaking, we suggest exposure time duration ranging from 8 hours to 30 days, the ideal value being 7 days.

Storage

The activated charcoal cartridges have undergone a complex conditioning process that ensures an outstanding chromatographic blank level, never exceeding three times the instrumental noise of a FID detector at the lowest attenuation. Kept in a cool place and away from volatile organic compounds, the cartridges maintain unchanging blank level and adsorbing capacity for at least two years. Expiry date and lot number are printed onto the plastic bag wrapping each cartridge: its integrity stands as warranty seal.

After exposure the cartridges, well capped and kept in a cool and solvent-free place, maintain their content unaltered for at least six months.

Analysis

Extraction

Introduce 2 ml of CS₂ and 100 µl of internal standard solution (see next page) directly in the **radiello** glass tube without drawing out the cartridge. **Always use class A volumetric pipettes or dispensers.** Stir from time to time for 30 minutes. If analysis is not performed soon after, draw out the cartridge and discard it.

Calibration

Outdoor environment sampling

If benzene, toluene, ethylbenzene and xylenes (BTEX) have to be analyzed, prepare three or four standard solutions in CS₂ having decreasing concentrations of the analytes in the following ranges (in mg·l⁻¹):

benzene	0.04-17.6	ethylbenzene	0.04-17.7
toluene	0.09-34.8	m-xylene	0.04-17.2
o-xylene	0.04-17.6	p-xylene	0.04-17.2

It is advisable to proceed via consecutive dilutions, starting for example from a stock solution containing 1 ml of each compound in 100 ml. Always use class A volumetric glassware. Introduce 2 ml of each standard solution, along with 100 µl of internal standard, onto a blank code 130 cartridge in its glass tube.

IMPORTANT

always use high purity grade CS₂, for example Fluka Cat. No. 84713 or Aldrich Cat. No. 34,227-0

BE CAREFUL

even refrigerated, CS₂ permeates the tube plastic cap: its volume decreases by 4-5% a day. If the internal standard has been added, it is only matter of unpleasant odour...



What makes the code 130 cartridge incomparable?

the container

The container is made of stainless steel cloth AISI 316 with 100 mesh grid opening. It is electric welded with no supply of foreign materials. It has tolerance of ± 0.05 mm diameter and of ± 0.1 mm length.

the contents

The cartridge is packed with vegetal activated charcoal with a very large adsorbing surface. Its exceptionally low blank is obtained by conditioning it in a nitrogen stream fluidised bed at 450 °C for 16 hours. The fluidised bed technique does not only guarantee the thorough purification of adsorbing material but also performs an accurate selection of its granulometry, by ventilation separations of the fraction under 50 mesh and over 35 mesh.



the production

The cartridge is filled up with charcoal by a very complex automated apparatus that was designed and realised in our laboratory. It avoids any contamination of the adsorbing material during the delicate process of cartridge production and ensures a very accurate dosing of the material itself, providing a variability of less than 2% of the weight of the activated charcoal among the cartridges.



the quality control

Each cartridge batch undergoes statistical quality control of the blank level. If amounts higher than 20 ng of each of the BTEX compounds are found, the entire lot is discarded.



	retention time (minutes)
methanol	4.834
ethanol	5.340
acetone	5.712
isopropanol	5.835
pentane	6.121
methyl acetate	6.346
dichloromethane	6.405
2-methylpentane	7.559
methylethylketone	7.719
3-methylpentane	7.941
ethyl acetate	8.331
n-hexane	8.402
isobutanol	8.763
methylcyclopentane	9.350
1,1,1-trichloroethane	9.636
butanol	9.956
isopropyl acetate	9.978
benzene	10.203
1-methoxy-2-propanol	10.424
cyclohexane	10.580
1,2-dichloropropane	11.285
trichloroethylene	11.625
isooctane	11.667
2-ethoxyethanol	11.831
propyl acetate	11.868
n-eptane	12.068
1-ethoxy-2-propanol	12.775
methylcyclohexane	12.912
methylisobutylketone	13.258
isobutyl acetate	14.005
toluene	14.055
butyl acetate	15.279
n-octane	15.435
tetrachloroethylene	15.601
diacetone alcohol	15.915
1-methoxy-2-propyl acetate	16.609
ethylbenzene	16.997
m+p-xylene	17.241
cyclohexanone	17.436
cyclohexanol	17.436
styrene	17.716
o-xylene	17.832
2-butoxyethanol	17.880
n-nonane	18.186
α -pinene	19.129
n-decane	20.334
n-undecane	22.142

the sampling rate measurements

The sampling rate is measured in a standard atmosphere chamber unique in Italy (and one of the few found all over Europe) that allows the dynamic generation of high flows of controlled concentration gas mixtures from $1 \mu\text{g}\cdot\text{m}^{-3}$ to $1,000 \text{mg}\cdot\text{m}^{-3}$ (dynamic range from 1 to 10^6) of each investigated compound alone or mixed with others. The chamber allows temperature control from -20 to 60 °C, relative humidity control from 5% to 100% and air speed variation from 0.1 to $10 \text{m}\cdot\text{s}^{-1}$.

All of the gas flows are measured as mass flows and have therefore the properties of primary standards. All of the operating parameters (gas flows, temperature, relative humidity, ...) are recorded and the records are available along with the certification documents.





Volatile organic compounds (VOCs) thermally desorbed

Radiello components to be used:

Yellow diffusive body code 120-2

Supporting plate code 121

Vertical adapter code 122 (optional)

Adsorbing cartridge code 145

Or: *radiello-ready-to-use* code 123-2 (also see page A8)

Principle

Code 145 is a stainless steel net cylinder, with $3 \times 8 \mu\text{m}$ mesh grid opening and 4.8 mm diameter, packed with 350 ± 10 mg of graphitised charcoal (Carbograph 4), particle size is 35-50 mesh.

Volatile organic compounds are trapped by adsorption and recovered by thermal desorption, analysis is performed by capillary gas chromatography and FID or MS detection.

General considerations

Thermal desorption is an easy-to-use technique, but it implies some precautions and is of less general use than chemical desorption.

The recovery of adsorbed compounds is based onto the different shape of adsorption isotherms at different temperatures. Since quantitative desorption of trapped molecules should ideally be accomplished at moderate temperatures, only weak adsorbing media are employed, with active adsorbing surface between 10 and 50 times smaller than that of activated charcoal.

Use of thermal desorption requires therefore an accurate preliminary investigation about the adsorbed compound - adsorbing medium pair. Stronger adsorbents are suitable for very volatile compounds, but will yield only partial desorption of heavier compounds.

Anyway, *backdiffusion* (see page A3) is always lying in wait: due to the adsorbing medium weakness heavier compounds will eventually displace the more volatile ones. Once you have made an accurate choice of the adsorbing material, therefore, you should bear in mind that a real atmosphere is composed by a variety of compounds apart from those you are analyzing at unpredictable concentrations. As a consequence, sampling times can not be as long as those allowed by activated charcoal, otherwise lighter compounds will be lost. With the purpose of allowing reasonable sampling times (up to two weeks) the sampling rate has been dramatically reduced by changing the diffusive body from the white type (code 120) to the yellow one (code 120-2).

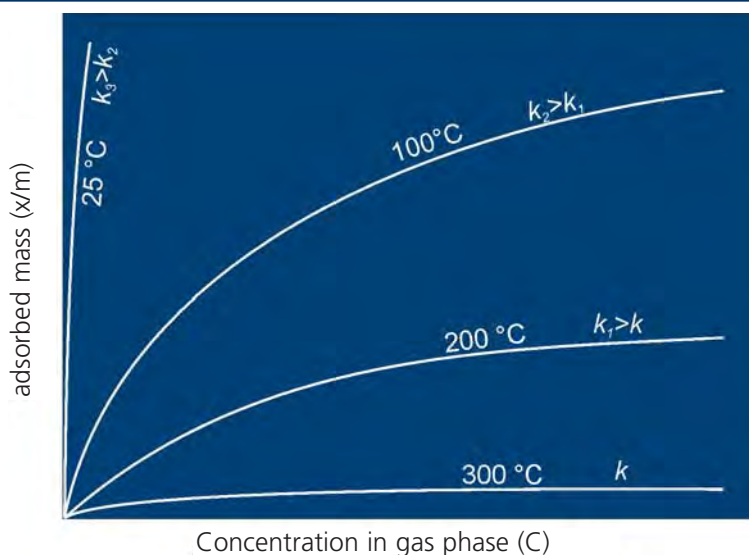

When in contact with a solid adsorbing medium, a gaseous compound will be adsorbed following the Freundlich isotherm, that is to say the adsorbed mass will be $x/m = kC^{1/n}$, where x is the mass of gaseous compound adsorbed by the mass m of the solid adsorbent and C is the concentration of the gaseous compound at the equilibrium in the gas phase. K and n depend on temperature and on the adsorbate - adsorbing medium pair. K increases with decreasing temperature and n is the closer to 1 the stronger the adsorbent.

At low temperatures, x/m depends almost linearly on the concentration in air (see the curve at 25 °C): this allows diffusive sampling. At high temperatures, the adsorbent mass is very low whatever the concentration in the gas phase: this allows the recovery of adsorbed compounds by heating (see the curve at 300 °C).

To ensure the best possible recovery yields, k and n have to be small. This, however, will compromise sampling efficiency. In other words, compounds strongly adsorbed at room temperature will be only partially recovered by thermal desorption. On the other hand, compounds that are easily desorbed by heating will be sampled at room temperature with low efficiency.



Smaller average pore size and thicker diffusive membrane make the diffusive path longer and, as a consequence, sampling rates are reduced to less than one third compared to those obtained with white diffusive bodies.

Some compounds, moreover, are thermally unstable. Thermal degradation of such compounds will cause an underestimation of their concentration or the appearance of ghost peaks.

Thermal desorption is nevertheless an outstanding analytical technique because it is easy to perform, it does not require the use of toxic solvents as carbon disulfide, it ensures very low limits of detection, is suited to mass spectrometric detection and allows the recovery of the adsorbing cartridges. Basing on our experience, we have chosen CarboGraph 4 as the best compromise between sampling efficiency and recovery yields for a wide range of organic compounds.

Sampling rates

Sampling rate values at 298 K (25 °C) and 1013 hPa are listed in table on page **E3**. All of the values shown have been experimentally measured. Exposure tests have been performed up to the levels shown (in $\mu\text{g}\cdot\text{m}^{-3}\cdot\text{min}$) and sampling rates are guaranteed to be linear up to the limit values and for overall concentration of volatile organic compounds in air not exceeding $2,000 \mu\text{g}\cdot\text{m}^{-3}$.

Effect of temperature, humidity and wind speed

Sampling rates varies from the value at 298 K on the effect of temperature (in Kelvin) as expressed by the following equation

$$Q_K = Q_{298} \left(\frac{K}{298} \right)^{1.5}$$

where Q_K is the sampling rate at the temperature K and Q_{298} is the reference value at 298 K. This produces a variation of $\pm 5\%$ for 10 °C variation (upwards or downwards) from 25 °C.

Sampling rate is invariant with humidity in the range 15-90% and with wind speed between 0.1 and 10 $\text{m}\cdot\text{s}^{-1}$.

Do not expose directly **radiello** to rain: even if only small amounts of water are adsorbed by CarboGraph 4, they can nevertheless interfere with the analysis.

Calculations

The listed sampling rate values take already into account the recovery yields of adsorbed compounds. **The average concentration over the sampling period is therefore calculated from sampled mass of analyte and exposure time without introducing any other corrective factor**, apart from temperature variations of Q .

Average concentration C in $\mu\text{g}\cdot\text{m}^{-3}$ over the whole exposure time is calculated according to the following expression:

$$C [\mu\text{g}\cdot\text{m}^{-3}] = \frac{m [\mu\text{g}]}{Q_K [\text{ml}\cdot\text{min}^{-1}] \cdot t [\text{min}]} \cdot 1,000,000$$

where:

m = mass of analyte in μg

t = exposure time in minutes

Exposure

Workplace environment

The weaker adsorbent Cabograph is not recommended for workplace measurements, as high concentrations, that can be expected, would overload the sorbent. A stronger adsorbent, like activated charcoal, is needed (see page D1)



Other indoor sampling experiments and outdoor campaigns

Thermal desorption is exceptionally suited for long exposure times at low concentrations, as in outdoor campaigns and some indoor environments (e.g. homes, schools, etc...), particularly if the subsequent analysis is performed by HRGC-MS. The recommended exposure times range from 8 hours to the upper limits shown in the table below. It is advisable to reduce sampling time if the estimated overall VOCs concentration is higher than 2,000 $\mu\text{g}\cdot\text{m}^{-3}$.

Sampling rate values Q at 25°C (298 K)

	Q_{298} ml·min ⁻¹	exposure time upper limit (days)	linear up to $\mu\text{g}\cdot\text{m}^{-3}\cdot\text{min}$	uncertainty (2 σ) %	limit of detection ¹ $\mu\text{g}\cdot\text{m}^{-3}$
benzene	27.8	7	410,000	8.3	0.05
benzene	26.8	14	410,000 ²	7.5	0.05
butyl acetate	24.5	14	580,000	12.4	0.05
2-butoxyethanol	19.4	14	550,000	9.7	0.1
cyclohexane	27.6	7	470,000	14.7	0.1
n-decane	22.3	14	450,000	22.4	0.1
1,4-dichlorobenzene	22.0	14	650,000	9.5	0.1
dimethyl disulfide	23.7	7	500,000	9.1	0.04
n-heptane	25.3	14	420,000	7.6	0.05
n-hexane	25.5	7	420,000	10.9	0.05
ethylbenzene	25.7	14	550,000	9.1	0.01
2-ethyl-1-hexanol	14.3	14	550,000	17.4	0.07
2-ethoxyethanol	26.0	14	570,000	7.7	0.05
2-ethoxyethyl acetate	20.9	14	600,000	8.0	0.05
isopropyl acetate	25.8	7	540,000	9.6	0.1
limonene	12.8	14	550,000	24.8	0.2
2-methoxyethanol	4.0	7	1,000,000	--	1.0
2-methoxyethyl acetate	21.0	7	1,000,000	--	0.1
1-methoxy-2-propanol	26.6	7	600,000	11.6	0.2
n-nonane	21.0	14	440,000	11.8	0.07
n-octane	24.1	14	440,000	13.4	0.07
α -pinene	6.4	14	550,000	29.5	0.2
styrene	27.1	14	550,000	24.0	0.01
tetrachloroethylene	25.4	7	1,000,000	8.9	0.02
toluene	30.0	14	550,000	8.3	0.01
1,1,1-trichloroethane	20.0	7	300,000	13.0	0.1
trichloroethylene	27.1	7	800,000	9.5	0.02
1,2,4-trimethylbenzene	21.9	14	550,000	9.6	0.05
n-undecane	12.0	14	520,000	32.7	0.05
m-xylene	26.6	14	550,000	11.3	0.01
o-xylene	24.6	14	550,000	9.1	0.01
p-xylene	26.6	14	550,000	11.3	0.01

¹after 7 days exposure and with MS detection; analytical conditions as described in the Analysis paragraph

²for overall VOCs concentrations not exceeding 500 $\mu\text{g}\cdot\text{m}^{-3}$

Storage

The cartridges have undergone a complex conditioning procedure that ensures an outstanding chromatographic blank level. If kept in a cool place without VOCs contamination, blank level and adsorbing capacity stay unaltered for at least eighteen months.

After exposure the cartridges, well capped and kept in a cool and solvent-free place, are stable for at least three months.



Analysis

The analytical methods hereafter described have been set up with the Perkin-Elmer Turbomatrix thermal desorber and Agilent 5973 MSD mass spectrometer detector. They may be implemented on other instruments by introducing minor adjustments as suggested by the analyst's experience and characteristics of employed instrumentation.

In the following we propose two methods, one for **BTEX** analysis and another for **VOCs**. The former is suited to outdoor sampling in urban monitoring, where investigation is usually focussed onto benzene, toluene, ethylbenzene and xylene isomers. The latter is conceived for indoor monitoring, allowing quantification of all the compounds listed on page E3 and also extended qualitative analysis. The two methods differ by a few details, such as the higher desorption temperature for VOCs and the higher cryofocusing temperature for BTEX. The latter caution is introduced to avoid freezing of excess humidity gathered during the sampling in the cryofocusing trap.

Desorption

The thermal desorber is equipped with 1/4" OD SS sample tubes, they have to be hollow and free: discard the stainless steel gauze disk which is fitted to the groove and discard also the springs if present.

Code 145 cartridge has been dimensioned to fit the diameter of Turbomatrix thermal desorption tubes. Its length is such that, when the cartridge is introduced into the tube and is stopped by the groove, it is positioned exactly centrally with respect to the tube length.

Inner diameter of Perkin-Elmer tubes is not always exactly the same; it may be the case therefore that a cartridge code 145 does not slide easily into the tube. Some pushing tool may be helpful then, such as a 500 µl syringe piston, a glass bar or an iron wire 2-3 mm thick.

In some cases the tube inner diameter is slightly larger than the cartridge outer diameter: the cartridge can therefore be pushed out from the tube during desorption due to the desorption gas pressure. If this is the case, make use of the springs provided along with the tubes.

Once capped, the Turbomatrix steel tube has to be positioned in the carousel with the grooves on the bottom.

The described conditions have been optimized for seven days exposures to typical concentrations of urban atmospheres and indoor environments. Shorter exposure times or considerably higher concentrations would require different settings of split flows, with the purpose of ensuring good analytical sensitivity or linearity of response.



Usually, the cartridge enters into the Turbomatrix tube by simple pouring. If it does not occur, use a pushing tool to press the cartridge till the nick on the tube.

BTEX

Temperatures and timing

- ✓ Desorption: 320 °C for 10 minutes
- ✓ Cryofocusing trap (Tenax TA): during primary desorption maintain 2 °C, secondary desorption at 99 °C/sec up to 290 °C, 1 minute at 290 °C
- ✓ Six port valve: 150 °C
- ✓ Transfer line: 200 °C

Flows

- ✓ Carrier gas: helium, 24 psi
- ✓ Desorption flow: 100 ml·min⁻¹
- ✓ Inlet split: 90 ml·min⁻¹
- ✓ Outlet split: 30 ml·min⁻¹

VOCs

Temperatures and timing

- ✓ Desorption: at 370 °C for 15 minutes
- ✓ Cryofocusing trap (Tenax TA): during primary desorption maintain at -20 °C, secondary desorption at 99 °C/sec up to 290 °C, 1 minute at 290 °C
- ✓ Six port valve: 150 °C
- ✓ Transfer line: 200 °C

Flows

- ✓ Carrier gas: helium, 24 psi
- ✓ Desorption flow: 100 ml·min⁻¹
- ✓ Inlet split: 90 ml·min⁻¹
- ✓ Outlet split: 30 ml·min⁻¹



Instrumental analysis

Analytical parameters for BTEX and VOCs are the same, apart from the duration of chromatographic run and final temperature.

We recommended the following conditions:

Column

100% dimethylpolysiloxane, length 50m x 0.2mm, film thickness 0.5 μm ; (e.g. Petrocol DH 50.2, Supelco Cat.No. 24133-U) the column is directly fitted to the six-port valve of Turbomatrix apparatus.

Temperatures

- ✓ GC oven: 40 °C for 3 minutes, 8 °C/min up to 80 °C, maintain for 1 minute, 20 °C/min up to 250 °C for BTEX and up to 280 °C for VOCs, final isotherm 1.5 minutes for BTEX and 3 minutes for VOC
- ✓ GC-MS interface: 270 °C

Flows

- ✓ Carrier gas: helium, 0.8 ml·min⁻¹

On page E6 we display two total ion current chromatograms from an outdoor urban site and an indoor sampling respectively.

In the first case, the benzene peak corresponds to an average concentration of 2.2 $\mu\text{g}\cdot\text{m}^{-3}$; in the second the concentration of 1,4-dichlorobenzene was 14 $\mu\text{g}\cdot\text{m}^{-3}$. Despite the low concentration values, the signal-to-noise ratio is very high in both cases. As a consequence, very reliable mass spectral identification is possible.

Calibration

Calibration curves are obtained by gas-phase injection of methanol solutions of the target compounds onto blank cartridges. Injections are performed through a GC injector, where a short piece (10 cm) of wide-bore (0.53 i.d.) deactivated uncoated column is installed. The other end bears a Swagelock reducing connection (1/16"-1/4"). The 1/4" Swagelock nut has to be equipped with a PTFE *ferrule* instead of the original steel one (use PTFE ferrules that come along with the Turbomatrix caps).

Introduce a blank cartridge in a Turbomatrix tube and fit the tube to the Swagelock nut. Maintain the injector at 200 °C but do not heat the oven. Inject slowly 1 μl of each calibration solution under nitrogen flow (50 ml/min) and let the system purge for 2 minutes. Analyze the cartridge as you would do with a sample.

We suggest you to prepare a complete set of calibration solutions by subsequent dilutions such as they contain, for example, 8, 4, 2, 1, 0.04, 0.02 and 0.01 $\mu\text{g}\cdot\mu\text{l}^{-1}$ of each compound.

USER TIP

If you perform several analyses, a barcode reader will greatly improve productivity in your laboratory and will also minimize the possibility of errors in the copying of sample labels.

Please contact us to help you in the implementation of the reader.

We have also developed software solutions for the analytical data processing and automated production of analysis reports.

USER TIP

For a very accurate BTEX calibration we offer the **preloaded cartridges code 407**.

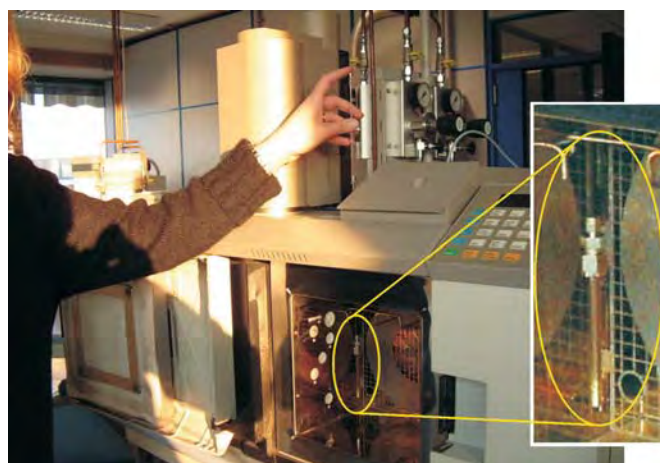

To prepare the calibration standards fit a 1/16"-1/4" Swagelock reducing connection to the GC injector by a short piece (10 cm) of wide-bore deactivated uncoated column.

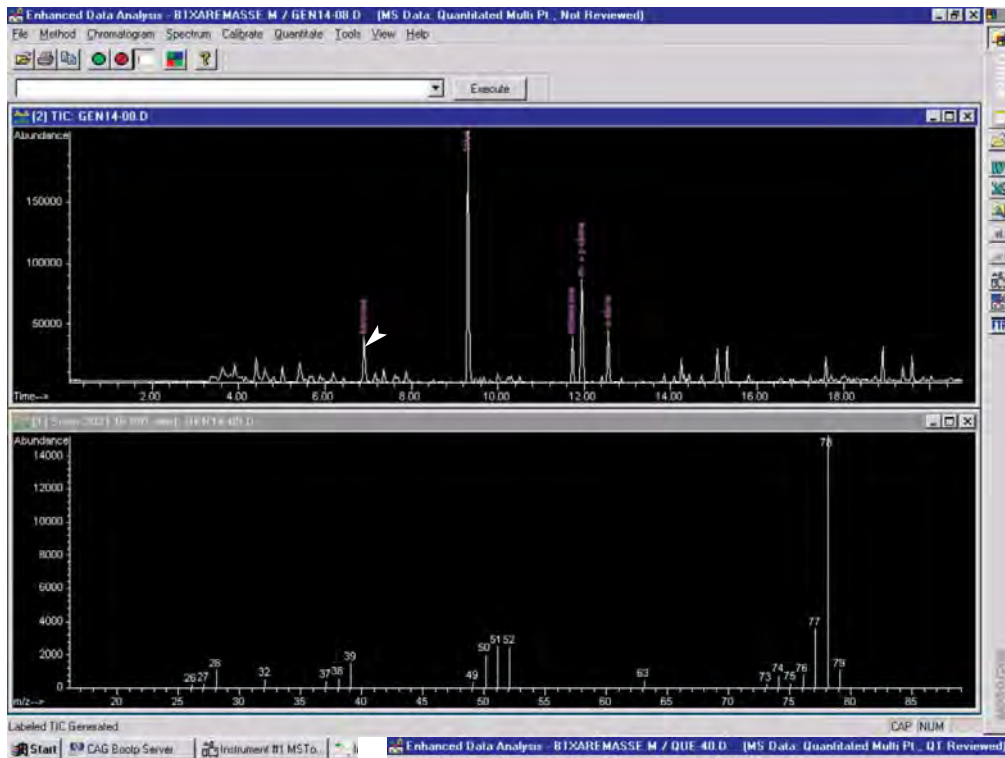

TIC chromatograms of an outdoor urban sampling (left) and of indoor air (bottom). Mass spectra of benzene and of 1,4-dichlorobenzene are shown on the bottom of each picture, at concentrations of 2.2 and 14 $\mu\text{g}\cdot\text{m}^{-3}$ respectively. Despite the low concentration values, the signal-to-noise ratio is very high in both cases.

As a consequence, very reliable mass spectral identification is possible by comparison with mass spectral data libraries with no need of further processing.

Cartridge recovery

In principle, the thermal desorption analysis leaves a conditioned cartridge that can be used as it is for another sampling. Actually this is not the case since the desorption yield, even if very high, is never quantitative, particularly for compounds with more than six carbon atoms. We recommend therefore to re-condition the cartridges after analysis, keeping them at 350 °C for eight hours under nitrogen flow.

Graphitized charcoal is a fragile material that exhibits a tendency to turn to dust under mechanical stress during the use on field and in the laboratory. Even if the stainless steel net mesh grid opening is a few micrometers, dust is lost anyway and the cartridge will eventually become empty. As soon as the mass of graphitized charcoal is reduced by 20% the cartridge has to be discarded. Basing onto our experience, this will occur after at least twenty sampling-and-analysis cycles.

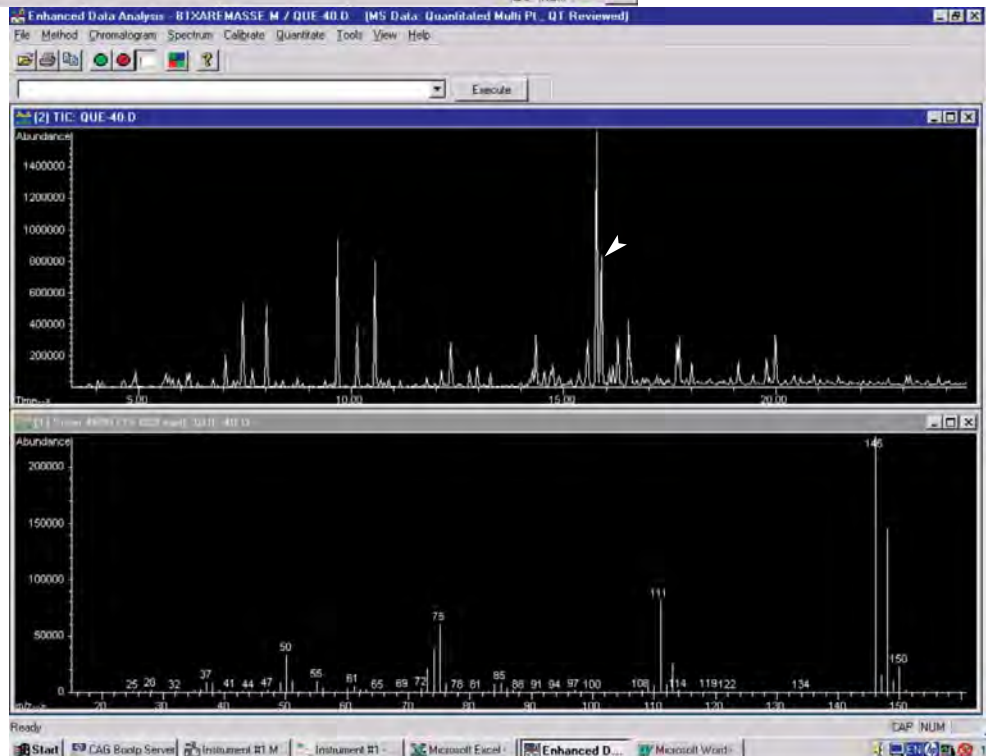



Nitrogen and sulfur dioxides (NO₂ and SO₂)

Radiello components to be used:

Blue diffusive body code 120-1

Supporting plate code 121

Vertical adapter code 122 (optional)

Chemisorbing cartridge code 166

Or: *radiello-ready-to-use* code 123-3 (also see page A8)

Principle

The cartridge code 166 is made of microporous polyethylene coated with triethanolamine (TEA). Nitrogen (NO₂) and sulfur (SO₂) dioxide is chemisorbed onto TEA as nitrite and sulphite or sulphate ions respectively. Nitrite is quantified by visible spectrophotometry while sulphite and sulphate are analysed by ion chromatography (NO₂ and SO₂ can be analysed together by ion chromatography).

Sampling is selective for gaseous molecules: any airborne nitrite, sulphite or sulphate will not cross the diffusive membrane.

Sampling rates

NO₂

The sampling rate value **Q** at 298 K (25°C) and 1013 hPa is **0.141 ± 0.007 ng·ppb⁻¹·min⁻¹**.

SO₂

The sampling rate value **Q** at 298 K (25°C) and 1013 hPa is **0.466 ± 0.022 ng·ppb⁻¹·min⁻¹**.

Effect of temperature, humidity and wind speed

Sampling rate of **NO₂** varies from the value at 298 K on the effect of temperature (in Kelvin) following the equation:

$$Q_K = Q_{298} \cdot \left(\frac{K}{298} \right)^{7.0}$$

where **Q_K** is the sampling rate at the temperature **K** ranging from 263 to 313 K (from -10 to 40 °C) and **Q₂₉₈** is the reference value at 298 K.

Sampling rate for **SO₂** does not vary with temperature between 263 and 313 K (from -10 to 40 °C).

Sampling rate is invariant with humidity in the range 15 - 90% and with wind speed between 0.1 and 10 m·s⁻¹ for both gases.

Calculations

NO₂

The concentration **C_{NO₂}** is calculated according to the equation:

$$C_{NO_2} = \frac{m_{NO_2}}{Q_K \cdot t}$$

where **m_{NO₂}** is nitrite mass in **ng** found on the cartridge, **t** is exposure time in **minutes** and **Q_K** is the sampling rate value at the temperature **K** in Kelvin.

SO₂

Convert the sulphite found onto the cartridge into sulphate by multiplying its mass by 1.2, then sum the obtained value to the sulphate found in the cartridge. The concentration in ppb is calculated according to the equation:

$$C_{SO_2} = \frac{m_{SO_4}}{0.466 \cdot t}$$

where **m_{SO₄}** is the overall sulphate mass in ng found in the cartridge (sulphate itself and sulphite converted into sulphate) and **t** is exposure time in minutes.

USER TIP

It is advisable to measure the sampling temperature by the thermometer **code 126**.



Exposure

Exposure up to 15 days is feasible but if relative humidity is higher than 70% for the entire sampling duration it is not advisable to sample for more than 7 days. Due to the fact that TEA is very hygroscopic in fact, even if water does not actually interfere with sampling or analysis, the excess water adsorbed by the cartridge could cause some loss of adsorbing medium by percolation.

Limit of quantitation and uncertainty

Sampling rate of NO₂ and SO₂ is linear ranging from 10,000 to 5,000,000 ppb·min. Limit of quantitation after 7 days exposure is 1 ppb for both gases. The uncertainty at 2σ is 11.9% for NO₂ and 9.2% for SO₂.

Storage

The cartridges are stable for at least 12 months before and 4 months after the sampling, if kept in the dark at 4 °C. Expiry date is printed on the plastic bag.

Do not expose all of the cartridges belonging to the same lot, keep at least two of them as blanks.

Analysis

Add **5 ml** of water in the plastic tube with the cartridge and stir vigorously by a vortexer for 1 minute. Do the same with two-three unexposed cartridges.

Colorimetric determination of nitrite ion

Nitrogen dioxide is quantitatively converted to nitrite ion. Prepare the following reactives:

- ✓ **sulphanilamide**: dissolve 10 g of sulphanilamide in 100 ml concentrated HCl and dilute to 1,000 ml with water
- ✓ **NEDA**: dissolve 250 mg of N-(1-naphthyl)ethylenediamine dihydrochloride in 250 ml of water (discard the solution when it turns brown).

Transfer 0.5 ml (or a different volume, see the table below) of the cartridge extraction solution to a plastic or glass 10 ml tube along with 5 ml of **sulphanilamide** reactive. Cap tightly, stir and wait for 5 minutes. Add 1 ml of **NEDA** reactive, stir and wait for 10 minutes. Do the same with unexposed cartridges.

Measure the absorbance of samples at 537 nm using water to zero the spectrophotometer, then subtract the blank value from unexposed cartridges. Prepare the calibration standards in the same way from sodium nitrite solutions of concentration ranging from 0.1 to 20 mg·l⁻¹ expressed as NO₂⁻.

When nitrite ion concentration is higher than 20 µg·ml⁻¹ (corresponding to 7 days of exposure to 70 ppb) the absorbance value is no longer comprised in the calibration curve. To analyse the samples, draw smaller amounts of the extraction solution as shown in the table. In order to maintain the overall volume unaltered, add the listed volume of water.

average expected concentration for 7 days exposure in ppb	sample volume ml	water volume to be added ml
up to 70	0.5	0
from 70 to 150	0.25	0.25
higher than 150	0.1	0.4

Determination of the sulphite and sulphate ions

Though SO₂ is converted into sulphite and sulphate ions with variable ratios, the sum of the two ion equivalents is linear with exposure to SO₂. To obtain calibration curves, prepare solutions containing both ions at concentrations ranging from 5 to 50 mg·l⁻¹. Perform the ion chromatography analysis of the standard solutions and the extraction solutions from **radiello** cartridges in the same way according to your usual laboratory practice.



Ozone (O₃)

Radiello components to be used:

Blue diffusive body code 120-1

Supporting plate code 121

Vertical adapter code 122 (optional)

Chemisorbing cartridge code 172

Or: **radiello-ready-to-use** code 123-5 (also see page A8)

Principle

The adsorbing cartridge is formed by a micropore polyethylene tube filled with silica gel coated with 4,4'-dipyridylethylene and closed, at one end, by a PTFE cap. Upon exposure, acid-catalysed ozonolysis of 4,4'-dipyridylethylene leads to 4-pyridylaldehyde.

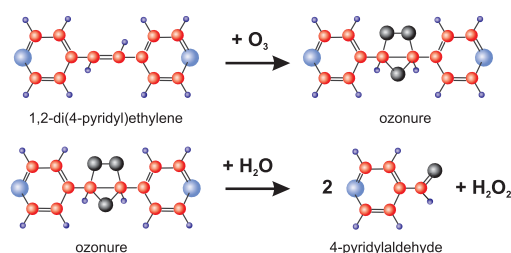

Silica gel ensures the presence of water, necessary to complete ozonolysis reactions.

In the laboratory, 4-pyridylaldehyde is condensed with 3-methyl-2-benzothiazolinone hydrazone (MTBH) to yield the corresponding azide, yellow coloured. The absorbance of the solution is measured at 430 nm. Production of 4-pyridylaldehyde is a specific reaction of ozone; neither nitrogen oxides nor organic compounds, if present, do interfere.

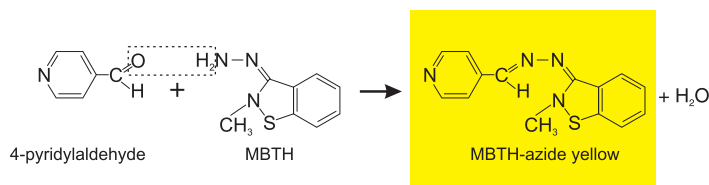

Sampling rate

The sampling rate value **Q** at 298 K (25°C) and 1013 hPa is **24.6 ml·min⁻¹**.

Sampling is linear in the exposure range from 10,000 to 4,000,000 µg·m⁻³·min⁻¹.

Effect of temperature, humidity and wind speed

Sampling rate varies from the value at 298 K on the effect of temperature (in Kelvin) as expressed by the following equation:

$$Q_K = Q_{298} \left(\frac{K}{298} \right)^{1.5}$$

where **Q_K** is the sampling rate at the temperature **K** and **Q₂₉₈** is the reference value at 298 K.

Sampling rate is not influenced by humidity or wind speed.

Calculations

The average concentration over the whole exposure time is calculated according to the equation

$$C [\mu\text{g}\cdot\text{m}^{-3}] = \frac{m [\mu\text{g}]}{24.6 t [\text{min}]} \cdot 1,000,000$$

where **m** is ozone mass in µg sampled by **radiello** and **t** is exposure time in minutes.



Exposure

Introduce the cartridge in the diffusive body and make sure **that the PTFE cap is positioned at the same end of the screw.**

In outdoor environments, where typical ozone concentrations range from 2 to 400 $\mu\text{g}\cdot\text{m}^{-3}$, we suggest exposure time from 24 hours to 14 days. The ideal range is from 3 to 7 days.

In workplace environments it is advisable to sample over the entire 8 hours shift.

Limit of detection and uncertainty

The limit of detection is 2 $\mu\text{g}\cdot\text{m}^{-3}$ for 7 days exposures. The cartridge is saturated after 14 days exposure at 400 $\mu\text{g}\cdot\text{m}^{-3}$. The uncertainty at 2σ is 14.5% over the whole sampling rate linearity range.

Storage

The cartridges need only protection from direct sunlight: keep them in a drawer or a cupboard at room temperature. In these conditions, the blank level does not exceed 0.015 absorbance units for up to six months.

Expiry date is printed onto the plastic bag wrapping each cartridge.

Generally, an increase of blank level does not imply that the cartridge must be discarded. The only consequence is a corresponding increase of the analytical limit of quantification.

After exposure the samples have to be stored in the dark as before, along with three unused cartridges to be analysed as blanks. Analyse them within a week.

Analysis

Reactives and materials

- ✓ 3-methyl-2-benzothiazolinone hydrazone hydrochloride (MBTH): dissolve 5 g per liter in water and add 5 ml of concentrated sulphuric acid; this solution is to be freshly prepared.
- ✓ 4-pyridylaldehyde
- ✓ micropore filter membrane 0.45 μm

USER TIP

For a simple and accurate filtration make use of the **filtration kit code 174.**

Procedure

Draw the cartridge out from the plastic tube, discard the PTFE cap and pour the silica gel into the tube. Add 5 ml of MBTH solution, recap the tube and stir vigorously. **Let the tube stand for at least one hour to react**, stirring from time to time. Filter through the micropore filter (if you make use of the code 174, act as follows: fit the filter to the syringe, transfer the solution from the tube to the syringe and filter it into a second tube or directly into the spectrophotometer measure cell).

Measure absorbance at 430 nm using water to zero the spectrophotometer. The yellow colour is stable for several days if the solution is kept well capped in its tube.

Treat in the same manner three unused cartridges of the same lot and subtract the average blank value from the absorbance values of the samples.

IMPORTANT

If the absorbance value is higher than the calibration curve upper limit dilute the sample with the MBTH solution: **never use water to dilute!** Water alters the pH of the solution with unpredictable variations in the linearity of absorbance values vs concentration.

Calibration

Dissolve 100 μl (112.2 mg at 20° C) of 4-pyridylaldehyde in 1 liter of water and dilute this solution (e.g. 1:2, 1:5, 1:10) to obtain calibration solutions. Transfer 0.5 ml of each calibration solution in a plastic tube together with 4.5 ml of MBTH solution. Stir and let stand for one hour, then read the absorbance at 430 nm (filtration is not needed). Plot the calibration curve for ozone mass vs measured absorbance, taking into account that:

$$1 \mu\text{g of 4-pyridylaldehyde} = 0.224 \mu\text{g of ozone.}$$



Hydrogen sulfide (H₂S)

Radiello components to be used

White diffusive body code 120

Supporting plate code 121

Vertical adapter code 122 (optional)

Chemisorbing cartridge code 170

Or: *radiello-ready-to-use* code 123-6 (also see page A8)

Principle

The cartridge code 170 is made of microporous polyethylene and impregnated with zinc acetate. Hydrogen sulphide is chemisorbed by zinc acetate and transformed into stable zinc sulfide.

The sulfide is recovered by extraction with water. In contact with an oxidizing agent as ferric chloride in a strongly acid solution it reacts with the N,N-dimethyl-p-phenyldiammonium ion to yield methylene blue.

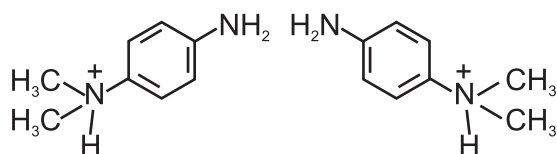

N,N-dimethyl-p-phenyldiammonium

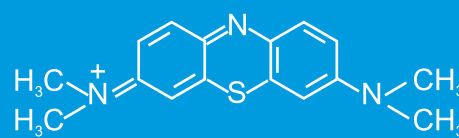
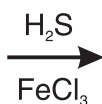

Methylene blue

Methylene blue is quantified by visible spectrometry.

Sampling rate

Sampling rate **Q** at 298 K (25°C) and 1013 hPa is **0.096 ± 0.005 ng-ppb⁻¹·min⁻¹**.

Effect of temperature, humidity and wind speed

Sampling rate varies from the value at 298 K on the effect of temperature (in Kelvin) as expressed by the following equation:

$$Q_K = 0.096 \left(\frac{K}{298} \right)^{3.8}$$

where **Q_K** is the sampling rate at the temperature K ranging from 268 to 313 K (from -5 to 40 °C).

Sampling rate is invariant with humidity in the range 10 - 90% and with wind speed between 0.1 and 10 m·s⁻¹.

Calculations

Once **Q_K** at the sampling temperature has been calculated, the concentration **C** is obtained according to the equation:

$$C = \frac{m}{Q_K \cdot t} \cdot 1,000$$

where **m** is the mass of sulphide ion in µg found onto the cartridge and **t** is exposure time in minutes.

Exposure

Exposure duration may vary from 1 hour to 15 days. Sampling is linear from 2,000 to 50,000,000 ppb·min of H₂S.



Limit of detection and uncertainty

The limit of detection is 30 ppb for 1 hour exposure or 1 ppb for 24 hour exposure. The uncertainty at 2σ is 8.7% over the whole exposure range.

Storage

The cartridges are stable at least for 12 months before and 6 months after exposure. Do not expose all of the cartridges of the same lot: keep at least two of them as blanks.

Analysis

Reactives

- ✓ **sulphuric acid**: slowly add 25 ml of concentrated sulphuric acid to 10 ml water and let the solution cool;
- ✓ **amine**: dissolve 6.75 g of N,N-dimethyl-p-phenylendiammonium oxalate in the **sulphuric acid** solution. Dilute this solution to 1 liter with sulphuric acid - water 1:1 v/v. Kept in a dark bottle and well capped, this solution is stable for at least four weeks. **CAUTION**: this solution is very poisonous.
- ✓ **ferric chloride**: dissolve 100 g of ferric chloride hexahydrate ($\text{FeCl}_3 \cdot 6\text{H}_2\text{O}$) in 40 ml of water.
- ✓ **ferric chloride-amine**: mix 10 ml of **ferric chloride** solution with 50 ml of **amine** solution. This solution has to be freshly prepared;
- ✓ **sulphuric acid for dilution**: slowly dissolve 40 ml of concentrated sulphuric acid in 900 ml of water, let the solution cool and make up to 1,000 ml.

Procedure

Add 10 ml of water to the plastic tube containing the cartridge, recap and stir vigorously, preferably by a VORTEX stirrer.

Add 0.5 ml of **ferric chloride - amine** solution, recap **immediately** and stir. The tube must be capped immediately in order to avoid that the developed hydrogen sulfide can escape from the tube before reacting.

Wait for 30 minutes and measure absorbance at 665 nm using water to zero the spectrophotometer. The colour is stable for several weeks.

Do the same with two or three unexposed cartridges of the same lot and obtain the average blank value, then subtract it to the samples.

IMPORTANT

Absorbance is linear up to 1,200 absorbance units, corresponding to an exposure value of about 80,000 ppb-min. If higher absorbance values are obtained, dilute the samples with the sulphuric acid for dilution.

Be careful to apply the same dilution ratio to the samples and the blanks.

NEVER USE WATER TO DILUTE.

Calibration

Calibration curves may be prepared by sodium sulfide standard solutions, which have to be titrated just before use. As diluted sodium sulfide solutions are very unstable (the sulfide content can diminish as much as the 10% in an hour) it is strongly recommended to make use of the calibration solution code 171, following the instructions included.

USER TIP

Code 171 calibration solution relieves you from the task of preparation and titration of the sodium sulfide solutions.



Ammonia (NH₃)

Radiello components to be used

Blue diffusive body code 120-1

Supporting plate code 121

Vertical adapter code 122 (optional)

Chemisorbing cartridge code 168

Or: *radiello-ready-to-use* code 123-7 (also see page A8)

Principle

The cartridge code 168 is made of microporous polyethylene and impregnated with phosphoric acid. Ammonia is adsorbed as ammonium ion. Airborne ammonium salts dispersed as particulate matter do not cross the diffusive membrane of radiello.

Ammonium ion is quantified by visible spectrometry as indophenol: at basic buffered pH ammonium ion reacts with phenol and sodium hypochlorite, with pentacyanonitrosylferrate catalysis (in the following *cyanoferrate*), to form indophenol. The reaction product is intensely coloured in blue, and its absorbance measured at 635 nm.

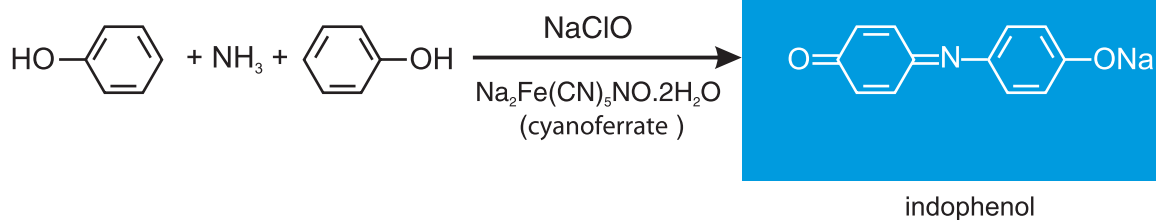

Sampling rate

Sampling rate **Q** at 298 K (25°C) and 1013 hPa is **235 ml·min⁻¹**.

Effect of temperature, humidity and wind speed

The effect of temperature on sampling rate is negligible (<0.1%/°C) in the range from 275 - 312 K (2 - 39 °C). Sampling rate is invariant with humidity in the range 10 - 90% and with wind speed between 0.1 and 10 m·s⁻¹.

Calculations

The concentration **C** in µg·m⁻³ is obtained according to the equation:

$$C = 0.944 \frac{m}{235 \cdot t} 1,000,000$$

where **m** is the mass of ammonium ion in µg found onto the cartridge and **t** is exposure time in **minutes**.

0.944 is the numerical factor necessary to convert ammonium ion into ammonia (see Analysis)

Exposure

Introduce the cartridge in the diffusive body and make sure **that the PTFE cap is positioned at the same end of the screw**.

Ammonia is sampled linearly in the range from 2,000 - 20,000,000 µg·m⁻³·min. Exposure time is allowed to range from 1 hour to 14 days.

IMPORTANT

Do not touch the microporous portion of the cartridge with your fingers: sweat contains ammonium ions.



Limit of detection and uncertainty

The limit of detection is $1 \mu\text{g}\cdot\text{m}^{-3}$ for 24 hour exposure. The uncertainty at 2σ is 6.5% over the whole allowed exposure range.

Storage

The cartridges are stable at least for 12 months before and after exposure if kept at room temperature in an ammonia-free environment. Do not expose all of the cartridges of the same lot: keep at least two of them as blanks.

Analysis

Materials

- ✓ plastic or glass tube, volume 12 ml, with cap
- ✓ micropipet with variable volume from 0.1 to 1.0 ml
- ✓ 5 ml glass pipet

Reactives

- ✓ *buffer* solution (pH 10.6): dissolve 1.1 g of NaOH and 3.04 g of NaHCO_3 in one liter of water
- ✓ *phenol*: dissolve 10 g of phenol in 100 ml of ethanol
- ✓ *cyanoferrate*: dissolve 0.5 g of sodium pentacyanonitrosylferrate dihydrate ($\text{Na}_2\text{Fe}(\text{CN})_5\text{NO}\cdot 2\text{H}_2\text{O}$) in 100 ml of water and add a few drops of 10% NaOH. Keep this solution in a dark bottle and prepare it freshly.
- ✓ *oxidising* solution: sodium hypochlorite with 1% of active chlorine in 0.2 M NaOH. Keep cool in a dark bottle.

Ammonium ion quantification

Open **radiello** tube and cautiously discard the cartridge PTFE cap (it may have been contaminated with handling). Help yourself with a pair of pliers.

Add 10 ml of deionised water to the cartridge in its tube (make sure that no trace of ammonium ion is found in the water you use). Recap the tube and stir vigorously by a VORTEX stirrer for at least 15 seconds.

Transfer 1 ml of the solution into another tube along with 0.4 ml of *phenol*, 0.4 ml of *cyanoferrate*, 5 ml of *buffer* solution and 1 ml of *oxidising* solution.

Wait for 1 hour and then measure the absorbance of the solution at 635 nm using water to zero the spectrophotometer.

Do the same with two unexposed cartridges and subtract their absorbance value to the samples. Generally, the blank value does not exceed 0.040 absorbance units.

For exposure value higher than $500,000 \mu\text{g}\cdot\text{m}^{-3}\cdot\text{min}$ the absorbance value is no longer linear: **dilute a known fraction of the coloured solution with the buffer.**

Calibration curves are conveniently prepared with ammonium chloride solutions in the range from 0.5 to $10 \text{ mg}\cdot\text{l}^{-1}$ as ammonium ion.

IMPORTANT

If sample is too concentrated (absorbance no longer linear) **DO NOT DILUTE WITH WATER:** the pH value is critical in the determination of the colour intensity.



Hydrochloric acid (HCl)

Radiello components to be used

White diffusive body code 120

Supporting plate code 121

Vertical adapter code 122 (optional)

Chemisorbing cartridge code 169

Or: *radiello-ready-to-use* code 123-8 (also see page A8)

Principle

Code 169 cartridge is made of stainless steel net loaded with silica gel (0.1 to 0.4 mm particle size). Gaseous hydrochloric acid is adsorbed by silica gel and subsequently extracted with water to be quantified by ion chromatography as chloride ion.

Sampling is selective for the gaseous molecules: any airborne chloride salt will not cross the diffusive membrane of **radiello**.

Sampling rate

Sampling rate Q at 298 K (25 °C) and 1013 hPa is **103 ml·min⁻¹**.

Effect of temperature, humidity and wind speed

Sampling rate varies from the value at 298 K (25 °C) on the effect of temperature (in Kelvin) as expressed by the following equation:

$$Q_K = Q_{298} \left(\frac{K}{298} \right)^{1.5}$$

where Q_K is the sampling rate at temperature K and Q_{298} is the sampling rate value at the reference temperature of 298 K. This yields a $\pm 5\%$ variation of Q for a 10 °C variation (upwards or downwards) from 25 °C.

Sampling rate is invariant with humidity in the range 15 - 90% for short exposure time (see Exposure) and with wind speed between 0.1 and 10 m·s⁻¹.

Calculations

Let m be the mass of chloride ion in μg found onto the cartridge and t the exposure time in minutes, the environmental concentration C of hydrochloric acid in $\mu\text{g}\cdot\text{m}^{-3}$ is obtained according to the equation:

$$C = \frac{1.028 \cdot m}{Q_K \cdot t} 1,000,000$$

where Q_K is the sampling rate at temperature K (in Kelvin) and 1.028 is the ratio between molecular masses of HCl and Cl⁻ (see Analysis).

Exposure

Hydrochloric acid is sampled linearly in the range from 20,000 - 20,000,000 $\mu\text{g}\cdot\text{m}^{-3}\cdot\text{min}$.

Workplace environment

In workplace environment we recommend exposure time from 15 minutes to 8 hours: the *ceiling* values can be measured.



Outdoor environment

We recommend exposure time from 2 hours to 2 days. Exposure time as long as 7 days is allowed if average relative humidity does not exceed 50%, taking into account the water absorbing properties of silica gel.

We also recommend to protect **radiello** from rain by the mountable shelter code 196.

Limit of detection and uncertainty

The limit of detection is $10 \mu\text{g}\cdot\text{m}^{-3}$ for 24 hour exposure. The uncertainty at 2σ is 3.5% over the whole allowed exposure range.

Interferents

Gaseous chlorine is adsorbed by silica gel and is revealed as 0.02 ng of chloride ion for $1 \mu\text{g}\cdot\text{m}^{-3}\cdot\text{min}$ of chlorine.

Storage

Kept in a clean environment free from gaseous hydrochloric acid, the cartridges code 169 are stable for at least 24 months before and after sampling.

If more than six months have passed since you received the cartridges, before environmental sampling campaigns, it is advisable to analyse some cartridges to check for contamination from the background. Discard the cartridges if they contain more than 5 μg of chloride ion.

Analysis

Add 2 ml of deionised water to the cartridge in its tube (make sure that no trace of chloride ion is found in the water you use). Recap the tube and stir vigorously by a VORTEX stirrer for 1-2 minutes. Analyse the solution by ion chromatography. Subtract the blank value obtained from two unexposed cartridges.

Prepare the calibration solutions with sodium or potassium chloride concentrations ranging from 0.5 to 25 mg/liter as Cl^- .



Hydrofluoric acid (HF)

Radiello components to be used:

Blue diffusive body code 120-1

Supporting plate code 121

Vertical adapter code 122 (optional)

Chemisorbing cartridge code 166

Or: *radiello-ready-to-use* code 123-3 (also see page A8)

Principle

The cartridge code 166 is made of microporous polyethylene coated with triethanolamine (TEA). Gaseous hydrofluoric acid is adsorbed by TEA and subsequently extracted with water to be quantified by ion chromatography or by ion selective electrode as fluoride ion.

Sampling is selective for the gaseous molecules: any airborne fluoride salt will not cross the diffusive membrane of **radiello**.

Sampling rate

Sampling rate Q at 298 K (25 °C) and 1013 hPa is **187 ml·min⁻¹**.

Effect of temperature, humidity and wind speed

Sampling rate is invariant with humidity in the range 10 - 90% for short exposure time (see Exposure) and with wind speed between 0.1 and 10 m·s⁻¹.

The effect of temperature is under investigation.

Calculations

Let m be the mass of fluoride ion in μg found onto the cartridge and t the exposure time in minutes, the environmental concentration C of HF in $\mu\text{g}\cdot\text{m}^{-3}$ is obtained according to the equation:

$$C = \frac{1.053 \cdot m}{187 \cdot t} 1,000,000$$

where 1.053 is the ratio between molecular masses of HF and F⁻(see Analysis).

Exposure

Hydrofluoric acid is sampled linearly in the range from 10,000 to 50,000,000 $\mu\text{g}\cdot\text{m}^{-3}\cdot\text{min}$.

Workplace environment

In workplace environments we recommend exposure time from 15 minutes to 8 hours: the *ceiling* values can be measured.

Outdoor environment

We recommend exposure time from 2 hours to 14 days.

Protect **radiello** from rain by the mountable shelter code 196.

Limit of detection and uncertainty

The limit of detection is 7 $\mu\text{g}\cdot\text{m}^{-3}$ for 24 hour exposure. The uncertainty at 2σ is 4.5% over the whole exposure range.



Storage

Kept in a dark place at 4 °C, the cartridges stay unaltered for at least 12 months before exposure and 4 months after sampling. Expiry date is printed on the plastic bag wrapping each cartridge.

If more than six months have passed since you received the cartridges, before environmental sampling campaigns, it is advisable to analyse some cartridges to measure any contamination from the background. Discard the cartridges if they contain more than 2 µg of fluoride ion.

Keep at least two unexposed cartridges for each lot and analyse them as blanks.

Analysis

Ion chromatography

Add 5 ml of eluent solution to the **radiello** tube. Stir vigorously by a VORTEX stirrer for 1-2 minutes. Let the tube stand for 10 minutes, then stir manually and inject the solution in the ion chromatographic apparatus without further treatment.

Analyse 1-2 unexposed cartridges and subtract the average blank value to the samples.

Ion Selective Electrode

Prepare an ionic strength buffer as follows. Dissolve 57 ml of acetic acid in 500 ml water and add 50 g of sodium chloride and 0.3 g of sodium citrate. When complete solubilisation has been achieved, adjust the pH value to 5-5.5 (ideal value is 5.3) by adding drops of 10 M sodium hydroxide. Make up to 1 liter with water.

Add 5 ml water to **radiello** tube and stir vigorously by a vortexer for 1-2 minutes, then let stand for 10 minutes.

Introduce a magnetic stirring bar in a 20 ml beaker, add 10 ml of ionic strength buffer and 1 ml of the extraction solution of the cartridge. Start the magnetic stirrer and make the potentiometric measurement by an ion selective electrode for fluorides. In the described analytical conditions, the electrode response should be linear in the range from 1 to 1,000 mg·l⁻¹ of F⁻ with slope close to 59 ± 0.5 (if potential is expressed in mV).

Analyse 1-2 unexposed cartridges and subtract the average blank value to the samples.

IMPORTANT

Always use water with fluoride content lower than 0.5 mg·l⁻¹.



Anaesthetic gases and vapours

N₂O, isoflurane, ethrane, halothane and sevorane

Radiello components to be used

Sampling kit code 125, containing 20 single packages each composed of:

1 permeative body (see code 120-3)

1 supporting plate (see code 121)

1 vertical adapter (see code 122)

1 adsorbing cartridge (see code 132)

the listed components are contained in a closed aluminum envelope, which is wrapped by a thermowelded paper-polyethylene bag.

The whole is sterilized by γ -rays.

The single components are also available **non-sterilized** in 20 pieces per package.



Principle

Code 132 cartridge is made of stainless steel net loaded with a mixture of molecular sieve and activated charcoal 35-50 mesh.

Nitrous oxide and halogenated anaesthetic gases permeate the silicone membrane and are sampled by the molecular sieve and by activated charcoal respectively.

The sampled compounds are displaced by a water-methanol mixture and are quantified by capillary gas chromatography and a headspace sampler.

N₂O, isoflurane, ethrane and halothane are detected by the Electron Capture Detector (ECD) with very good sensitivity; sevorane can not be quantified by ECD detection and has to be analyzed by mass spectrometry.

Sampling rates

Sampling rate values Q at 298 K (25 °C) and 1013 hPa are listed in the table on the right.

Effect of temperature, humidity and wind speed

Sampling rate varies from the values at 298 K on the effect of temperature (in Kelvin) as expressed by the following equation:

$$Q_K = Q_{298} \left(\frac{K}{298} \right)^{1.5}$$

where Q_K is the sampling rate at temperature K and Q_{298} is the sampling rate value at reference temperature of 298 K. This yields a $\pm 5\%$ variation of Q for a 10 °C variation (upwards or downwards) from 25 °C.

Sampling rate is invariant with humidity in the range 10 - 90% for exposure time not exceeding 8 hours and with wind speed between 0.1 and 10 m·s⁻¹.

	Q ₂₉₈ (ml·min ⁻¹)
N ₂ O	1.01
forane (isoflurane)	2.25
ethrane	3.39
halothane	4.93
sevorane	0.92



Calculations

Concentration in air is obtained by the following equation:

$$C = \frac{m}{Q_K \cdot t} 1,000$$

where:

C = concentration in $\text{mg}\cdot\text{m}^{-3}$

m = mass of analyte found on the cartridge in μg

Q_K = sampling rate in $\text{ml}\cdot\text{min}^{-1}$

t = exposure time in minutes

Exposure

Sampling rate is constant for exposure time up to 8 hours at relative humidity up to 80% with N_2O concentration up to 500 ppm and overall halogenated anaesthetic compounds concentration up to 100 ppm.

Exposure time longer than 8 hours in presence of relative humidity higher than 80% leads to the loss of the nitrous oxide already sampled by the effect of competing water vapour adsorption on the molecular sieve sites.

Limit of detection and uncertainty

The cartridges are conditioned to ensure a chromatographic blank level lower than three times the instrumental noise at the minimum attenuation.

If a well conditioned ECD is employed, 4 hours of exposure ensure the following analytical sensitivities: 0.5 ppm of N_2O , 0.002 ppm of forane, 0.01 ppm of ethrane and 0.002 ppm of halothane. **Sevorane is not detected by ECD.** The Flame Ionisation Detector (FID) can be employed instead with acceptable sensitivity, but if nitrous oxide and the other halogenated compounds have to be quantified at the same time, a mass spectrometry detector must be used. Acquiring by the SIM (Single Ion Monitoring) technique detection limits close to the ECD performances can be achieved for N_2O , forane, ethrane and halothane. For sevorane, 1 hour exposure allows to detect 0.1 ppm.

The uncertainty at 2σ is: 5.5% for N_2O , 4.7 - 5.6% for forane, ethrane and halothane with ECD detection, 6.2% for N_2O and 5.5 - 6.2% for forane, ethrane, halothane and sevorane with MS detection.

Storage

The sampling kit code 125 is sterilized by γ -rays. Use of the sampler makes it no longer sterile. With the exception of the adsorbing cartridge, the sampler is indefinitely re-usable. After the first sampling, if you can arrange for sterilization by yourselves you only need to re-order code 132 cartridges to perform other sampling campaigns. Adsorbing cartridges need not to be sterile.

If kept in a dry place free from chemical contamination, the cartridges are stable for at least 12 months.

After the sampling, the cartridges are stable for 30 days if stored with the same precautions.

IMPORTANT

DO NOT STERILIZE THE SAMPLER BY AUTOCLAVING. Autoclaving treatment **permanently** damages the silicone permeative membrane.

Analysis

Materials needed for the analysis

- ✓ 20 ml headspace glass vials with open-top aluminum crimp caps and rubber/PTFE septa
- ✓ water/methanol mixture 60/40 v/v
- ✓ usual laboratory glassware



Materials needed for the calibration curve

- ✓ pure N₂O in a gas cylinder
- ✓ halogenated anaesthetic compounds
- ✓ gastight syringe (volume 500 µl) and other syringes (volume 100 and 10 µl)
- ✓ 1 liter glass bottle with threaded neck, equipped with open-top screw cap and rubber/PTFE septum (*the volume of the bottle must be precisely measured and the bottle must be rinsed with dry nitrogen before use*)
- ✓ magnetic stirrer with large magnetic stirring bar (about 30-40 mm long)
- ✓ usual laboratory glassware

Extraction

Introduce 10 ml of water/methanol mixture in a headspace vial by a volumetric pipette. Add the **radiello** cartridge and cap immediately. Stir and let equilibrate, place the vial in the headspace bath and let equilibrate for one hour at 45 °C.

Instrumental analysis

ECD detection (sevorane is not detected)

- ✓ vial pressurization gas: N₂ at 1.2 atm
- ✓ loop volume: 1 ml
- ✓ gas chromatographic column: polystyrene-divinylbenzene PLOT, 30m x 0.32mm, film 20µm (e.g. Supel-Q-PLOT, Supelco cat.no. 24242) (allows quantification of nitrous oxide and other anaesthetic gases in one chromatographic run)
- ✓ carrier gas: N₂ at 1.0 atm
- ✓ split ratio: 10/1
- ✓ make-up gas: Ar-CH₄ (CH₄ 10% v/v) at 30 ml·min⁻¹
- ✓ GC oven: 40° C for 2 min, 10° C·min⁻¹ up to 150° C, 6° C·min⁻¹ up to 200° C, final isotherm for 5 minutes
- ✓ injector temperature: 150° C
- ✓ detector temperature: 300° C

In the described analytical conditions chromatogram similar to the one in the figure are obtained. In the example shown, exposure time was 4 hours at the concentration values indicated and with relative humidity of 70%.

MS detection

The instrumental conditions are as described above, with the exception of the carrier gas (helium has to be used instead) and the make-up gas, which is not employed. Acquire by SIM (Single Ion Monitoring) focussing the detector on the following signals (the base peak is underlined):

N₂O: 44; **forane** and **ethrane:** 51, 67, 117; **halothane:** 117, 198, 179; **sevorane:** 33, 131, 181

If high concentrations of CO₂ interfere (it gives a strong signal at m/z 44), N₂O can be quantified basing on the signal at m/z 30. On page L4 a typical GC-MS chromatogram (as total ion current) is displayed. It can be observed that, as an effect of the vacuum applied on the detector end of the column, retention times are shorter with respect to those obtained with ECD detection.

Calibration

Calibration curves for N₂O and halogenated anaesthetics can be prepared simultaneously.

Draw pure N₂O in a gas sampling bulb. Transfer 20 ml of pure N₂O in the 1 liter bottle through the septum by a gastight syringe. Switch on the magnetic stirrer and let the mixture equilibrate for 30 minutes.

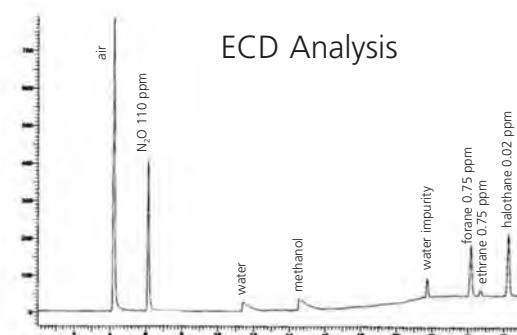



TIC

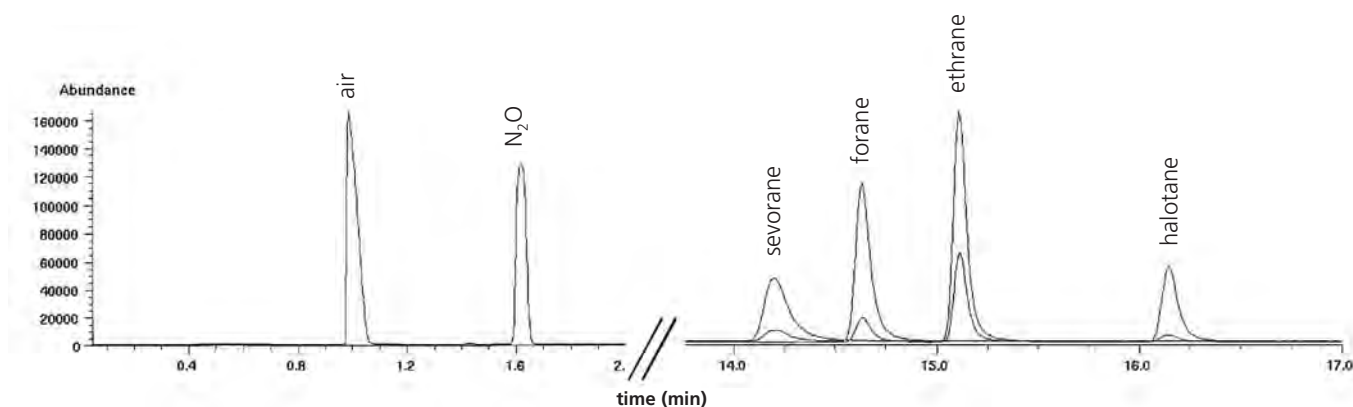

Standard solutions of the halogenated compounds must be prepared in water/methanol 60/40 v/v in order to contain from 0.05 to 3.0 mg/l of each compound; five calibration levels are recommended.

For each level pipet 10 ml of calibration solution in an empty vial, add a blank code 132 cartridge and cap immediately.

Add also a precisely measured volume of diluted N_2O drawn from the bottle by a gastight syringe (usually added volume ranges from 50 to 1,000 μ l), stir and let equilibrate at 45 °C for 1 hour.

The values above generally comprise the usual conditions of operating theatres. The analyst may choose different values if needed, but equivalent exposure values should not exceed 400,000 $mg \cdot m^{-3} \cdot min$ for nitrous oxide and 50,000 $mg \cdot m^{-3} \cdot min$ for each of the halogenated compounds.

Pay attention: the ECD response may not be linear. If this should be the case, use a **second order calibration curve**.

Useful data

name	chemical formula	molecular weight	1 $mg \cdot m^{-3}$ at 25°C = ppm
nitrous oxide	N_2O	44	0.556
forane	$CHF_2-O-CHCl-CF_3$	184.5	0.133
ethrane	$CHF_2-O-CF_2-CHClF$	184.5	0.133
halothane	$CF_3-CHBrCl$	197.4	0.124
sevorane	$CH_2F-O-CH(CF_3)_2$	200	0.123



phenol, methylphenol and dimethylphenol (thermally desorbed)

Radiello components to be used

White diffusive body code 120

Supporting plate code 121

Vertical adapter code 122 (optional)

Adsorbing cartridge code 147

Principle

Code 147 cartridge is a stainless steel net cylinder with 100 mesh grid opening and 4.8 mm diameter, packed with 250 ± 10 mg of Tenax-TA, particle size 20-35 mesh. Phenols are trapped by adsorption and recovered by thermal desorption, analysis is performed by capillary gas chromatography and MS detection.

The method has been optimized for the following compounds:

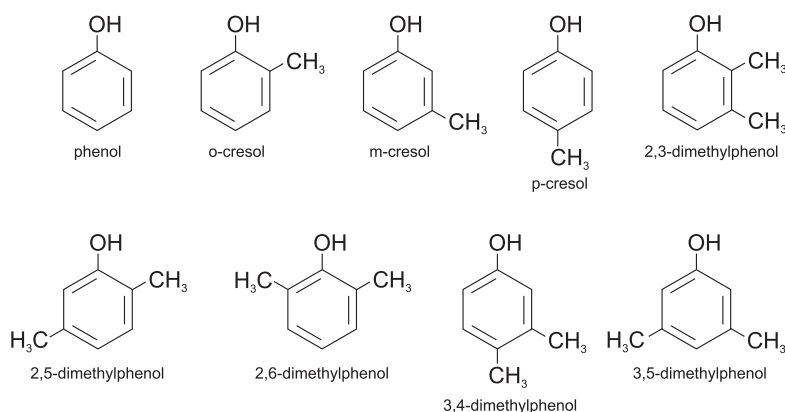

Sampling rates

Sampling rate values Q at 298 K (25 °C) and 1013 hPa are listed in the table on the right. All of the values shown have been experimentally measured.

Effect of temperature, humidity and wind speed

Sampling rate varies from the value at 298 K on the effect of temperature (in Kelvin) as expressed by the following equation:

$$Q_K = Q_{298} \left(\frac{K}{298} \right)^{1.5}$$

where Q_K is the sampling rate at the temperature K and Q_{298} is the reference value at 298 K. Sampling rate is invariant with humidity in the range 15 - 90% and with wind speed between 0.1 and 10 m·s⁻¹.

	Q_{298} ml·min ⁻¹	limit of detection ¹ µg·m ⁻³	uncertainty at 2σ %
phenol	38	0.3	24.1
o-cresol	45	0.4	17.5
m-cresol	48	0.4	8.0
p-cresol	48	0.4	8.0
2,3-dimethylphenol	53	0.4	26.0
2,5-dimethylphenol	51	0.3	25.2
2,6-dimethylphenol	46	0.4	7.6
3,4-dimethylphenol	60	0.4	22.1
3,5-dimethylphenol	61	0.4	22.2

¹after 24 hours exposure and with MS detection; analytical conditions as described in the Analysis paragraph.



Calculations

The listed sampling rate values take already into account the recovery yields of adsorbed compounds. **The average concentration over the sampling period is therefore calculated from sampled mass of analyte and exposure time without introducing any other corrective factor**, apart from temperature variations of Q.

Average concentration **C** in $\mu\text{g}\cdot\text{m}^{-3}$ over the whole exposure time is calculated according to the following expression:

$$C [\mu\text{g}\cdot\text{m}^{-3}] = \frac{m [\mu\text{g}]}{Q_K [\text{ml}\cdot\text{min}^{-1}] \cdot t [\text{min}]} \cdot 1,000,000$$

where:

m = mass of analyte in μg

t = exposure time in minutes

Q_K = sampling rate at temperature K

Exposure

Workplace environment

Exposure time can range from 2 to 8 hours.

Other indoor sampling experiments and outdoor campaigns

The recommended exposure times range from 8 hours to 7 days.

Storage

If cartridges are kept in a cool place without phenol and related compounds contamination, blank level and adsorbing capacity stay unaltered for at least 24 months.

After exposure the cartridges, well capped and kept in a cool and solvent-free place, maintain their content unaltered for at least three months.

Analysis

The analytical method hereafter described have been set up by the Perkin-Elmer Turbomatrix thermal desorber and Agilent 5973 MSD mass spectrometer detector. They may be implemented on other instruments by introducing minor adjustments as suggested by the analyst's experience and characteristics of employed instrumentation.

Desorption

The thermal desorber is equipped with 1/4" OD SS sample tubes, they have to be hollow and free: discard the stainless steel gauze disk which is fitted to the groove and discard also the springs if present.

Code 147 cartridge has been dimensioned to fit the diameter of Turbomatrix thermal desorption tubes. Its length is such that, when the cartridge is introduced into the tube and is stopped by the groove, it is positioned exactly centrally with respect to the tube length.

Inner diameter of Perkin-Elmer tubes is not always exactly the same; it may be the case therefore that a cartridge code 147 does not slide easily into the tube. Some pushing tool may be helpful then, such as a 500 μl syringe piston, a glass bar or an iron wire 2-3 mm thick. In some cases the tube inner diameter is slightly larger than the cartridge outer diameter: the cartridge can therefore be pushed out from the tube during desorption due to the desorption gas pressure. If this is the case, just press slightly one end of the cartridge to make it oval.

Once capped, the Turbomatrix steel tube has to be positioned in the carousel with the grooves on the bottom.





Temperatures and timing

- ✓ Desorption: 280 °C for 10 minutes
- ✓ Cryofocusing trap (Tenax TA): during primary desorption maintain at 2 °C, secondary desorption at 99 °C/sec up to 290 °C, maintain at 290 °C for 1 minute
- ✓ Six port valve: 150 °C
- ✓ Transfer line: 200 °C

Flows

- ✓ Carrier gas: helium, 24 psi
- ✓ Desorption flow: 100 ml·min⁻¹
- ✓ Inlet split: 80 ml·min⁻¹ (flow from tube to cryofocusing trap: 20 ml·min⁻¹)
- ✓ Outlet split: 25 ml·min⁻¹

Instrumental analysis

Column

100% dimethylpolysiloxane, length 50m x 0.2mm, film thickness 0.5 µm; (e.g. Petrocol DH 50.2, Supelco Code 24133-U) the column is directly fitted to the six-port valve of Turbomatrix apparatus

Temperatures

- ✓ GC oven: 50 °C for 2 minutes, 8 °C/min up to 160 °C, 12 °C/min up to 260 °C, final isotherm 2 minutes
- ✓ GC-MS interface: 260 °C

Flows

- ✓ helium carrier gas: 0.8 ml·min⁻¹

In the figure on the right a typical chromatogram (as total ion current) is shown.

Calibration

Calibration curves are obtained by gas-phase injections of methanol solutions of the analyzed compounds onto blank cartridges. Injections are performed through a GC injector, where a short piece of wide-bore (0.53 mm i.d.) deactivated uncoated column is installed. The other end bears a Swagelock reducing connection (1/16" to 1/4"). The 1/4" Swagelock nut has to be equipped with a PTFE **ferrule** instead of the original steel one (use PTFE ferrules that come along with the Turbomatrix caps).

Introduce a blank code 147 cartridge in a Turbomatrix tube and fit the tube to the Swagelock nut. Keep the injector at 200 °C but do not heat the oven. Slowly inject 1 µl of each calibration solution under nitrogen flow (50 ml·min⁻¹) and let the system purge for 2 minutes. Analyze the cartridge as you would do with a sample.

We suggest you to prepare a complete set of calibration solutions by subsequent dilutions such as they contain, for example, 4, 2, 1, 0.05 and 0.010 µg·µl⁻¹ of each compound.

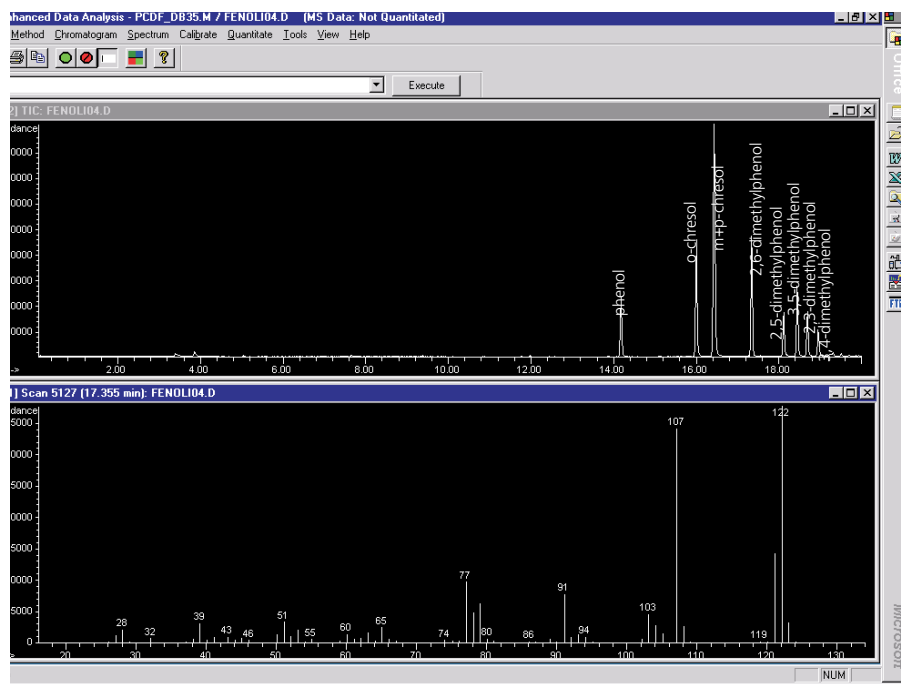



Cartridge recovery

Recovery yield of phenol and related compounds is higher than 98%. Nevertheless, traces of analyzed compounds remain on the cartridge, but a thorough regeneration can be performed as follows.

Wash the cartridge with methanol (5 ml in a glass tube are enough) stirring from time to time. Let it dry in the air and finally condition it at 300 °C for two hours under nitrogen or helium flow.

Thermal stability of Tenax-TA is good enough to allow a great number of sampling, analysis and conditioning cycles, provided that conditioning temperature does not exceed 300 °C and nitrogen or helium employed do not contain more than 10 ppm of oxygen.

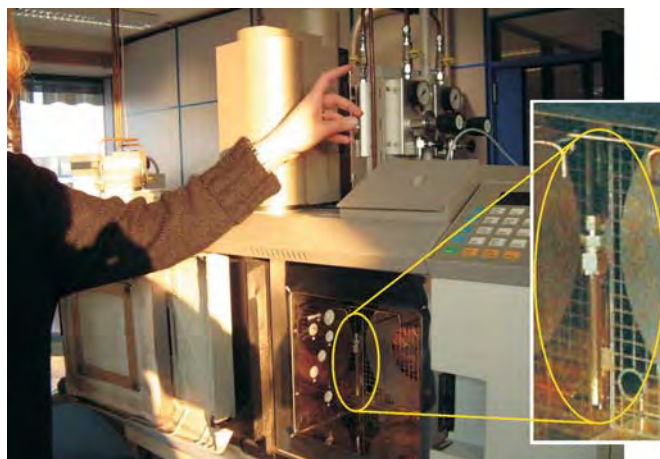

Calibration standards are easy to prepare by applying to the gas chromatograph injector a Swagelok reducing connection (1/16 to 1/4"); injections are performed through a GC injector, where a short piece of wide-bore (0.53 mm i.d.) deactivated uncoated column is installed.

Analytical service for radiello diffusive sampler

Analytical services are also available to European users directly through the Fondazione Salvatore Maugeri. Users can send the sampled cartridges in for analysis and results. For more information on prices and conditions of this service, please contact directly

FONDAZIONE SALVATORE MAUGERI - IRCCS

Centro di Ricerche Ambientali

Via Svizzera, 16

35127 PADOVA

Italy

tel. +39 0498 064 511

fax +39 0498 064 555

e.mail fsmpd@fsm.it

web www.radiello.com





Index by code

Radiello Code	Supelco Cat. No.	Description	Page
120	RAD120	diffusive body, white	A5, A8
120-1	RAD1201	diffusive body, blue	A5, A8
120-2	RAD1202	diffusive Body, yellow	A5, A8
120-3	RAD1203	permeative diffusive body, silicone membrane	A5
121	RAD121	triangular support plates	A5, A8
122	RAD122	vertical adapters for personal sampling	B1
122-1	RAD1221	vertical snapping adapters for ready-to-use sampler	A8
123-1	RAD1231	ready-to-use sampler BTEX/VOCs (chemical desorption)	A8
123-2	RAD1232	ready-to-use sampler BTEX/VOCs (thermo desorption)	A8
123-3	RAD1233	ready-to-use sampler NO ₂ /SO ₂ /HF	A8
123-4	RAD1234	ready-to-use sampler aldehydes	A8
123-5	RAD1235	ready-to-use sampler Ozone	A8
123-6	RAD1236	ready-to-use sampler H ₂ S	A8
123-7	RAD1237	ready-to-use sampler NH ₃	A8
123-8	RAD1238	ready-to-use sampler HCl	A8
124-1	RAD1241	screw caps for ready-to-use sampler	A8
124-2	RAD1242	containers, polypropylene for ready-to-use sampler	A8
125	RAD125	sterile sampler for anaesthetic gases and vapours	L1
126	RAD126	thermometer kit	B3
126-1	RAD1261	thermometer kit for ready-to-use sampler	B3
127	RAD127	thermometer reader with serial port	B3
130	RAD130	adsorbing cartridges for BTEX/VOCs (chemical desorption)	D1
132	RAD132	adsorbing cartridges for anaesthetic gases/vapours	L1
145	RAD145	adsorbing cartridges, for BTEX/VOCs (thermo desorption)	E1
147	RAD147	adsorbing cartridges for phenols	M1
165	RAD165	adsorbing cartridges for aldehydes	C1
166	RAD166	adsorbing cartridges for HF/NO ₂ /SO ₂ ,	F1
168	RAD168	adsorbing cartridges for NH ₃	I1
169	RAD169	adsorbing cartridges for HCl	J1
170	RAD170	adsorbing cartridges, for H ₂ S	H1
171	RAD171	calibration solution for H ₂ S	B4, H2
172	RAD172	adsorbing cartridges for ozone	G1
174	RAD174	filtration kit - syringes & filters, 0.45um porosity	B4, C3
175	RAD175	empty cartridges, 5.9mm OD, SS net, 100 mesh	B6
176	RAD176	empty cartridges, 4.8mm OD, SS net, 100 mesh	B6
177	RAD177	empty cartridges, 4.8mm OD, SS net, 3x8µm porosity	B6
190	RAD190	barcode label, self-adhesive	A5, B6
195	RAD195	clips for triangular support plates	B6
196	RAD196	protective shelter for outdoor sampling	B1
198	RAD198	plastic strips for protective shelter	B2, B6
199-1	RAD1991	empty glass tubes, 2.8mL, with stopper	B6
199-2	RAD1992	empty polypropylene tubes, 12mL, with stopper	B6
302	RAD302	calibration solution aldehydes	B4, C3
405	RAD405	calibration kit for BTEX - (chemical desorption)	B5
406	RAD406	calibration kit VOCs - (chemical desorption)	B5
407	RAD407	calibration kit BTEX - (thermal desorption)	B6



Index by subject

- acetaldehyde, B4, **C1**
acetone, **D2**, D6
acetonitrile, **D2**
acrylonitrile, **D2**
acrolein, B4, **C1**, C3
activated charcoal, A2, A3, B5, **D1**, D6, E1, L1
activated charcoal, duration and storage, **D4**, **L2**
adsorbing surface, **A1**
adsorption isotherm, **E1**
aldehydes, B4, **C1**
aldehydes, analyses, **C3**
aldehydes, duration and storage, **C2**
aldehydes, exposure, **C2**
aldehydes, interferences, **C4**
aldehydes, sampling rates, **C1**
ammonia, A8, **I1**
amyl acetate, **D2**
anaesthetic gases and vapors, **L1**
axial diffusion, **A1**, A2
back diffusion, **A3**, E1
barcode label, **A5**, A6, **B6**
barcode label, instruction, **A6**
benzaldehyde, B4, **C1**
benzene, A3, B5, B6, **D2**, D4, D5, **E3**, E4, E5
benzyl alcohol, **D2**
breakthrough, **A3**
bromochloromethane, **D2**
BTEX, desorbed with CS₂, **D5**
BTEX, thermally desorbed, **E4**
butanal, B4, **C1**
butanol, **D2**
sec-butanol, **D2**
ter-butanol, **D2**
2-butoxyethanol, **D2**, D6, **E3**
2-butoxyethyl acetate, **D2**
butyl acetate, **D2**, D6, **E3**
calibration, kit for BTEX thermally desorbed, **B6**
calibration, kit for BTEX with CS₂, **B5**
calibration, kit for COVs workplace environments, **B5**
calibration, solution for H₂S, **B4**
carbon tetrachloride, **D2**
clip, A5, **B6**
chlorobenzene, **D2**
chloroform, **D2**
components of radiello, **A5**
COVs (see volatile organic compounds)
m-cresol (2-methylphenol), **M1**
o-cresol (3-methylphenol), **M1**
p-cresol (4-methylphenol), **M1**
cyanoferrate, **I1**
cyclohexane, **D2**, D6, **E3**
cyclohexanol, **D2**, D6
cyclohexanone, **D2**, D6
n-decane, **D2**, D6, **E3**
desorption with CS₂, **D1**
diacetone alcohol, **D2**, D6
1,4-dichlorobenzene, **D2**, **E3**, E5, E6
1,2-dichloroethane, **D2**
dichloromethane, **D2**, D6
1,2-dichloropropane, **D2**, D6
diethyl ether, **D2**
diffusive body - blue, **A5**, A8, C1, F1, G1, H1, I1, K1, J1
diffusive body: section, **A1**
diffusive body - white, **A5**, A8, D1, E2, H1, I1, K1, J1, M1
diffusive body - yellow, **A5**, A8, E1, E2
diffusive surface, **A1**, A2, A3
dimethyl disulfide, **E3**
N,N-dimethylformamide, **D2**
N,N-dimethyl-*p*-phenyldiammonium, **H1**
2,3-dimethylphenol, **M1**
2,5-dimethylphenol, **M1**
2,6-dimethylphenol, **M1**
3,5-dimethylphenol, **M1**
3,5-dimethylphenol, **M1**
2,4-dinitrophenylhydrazine, **C1**, C3
1,4-dioxane, **D2**
1,2-di(4-pyridyl)ethylene, **G1**
n-dodecane, **D2**
empty cartridge, **B6**
end caps for glass tubes, **B6**
ethanol, **D2**
ethyl acetate, **D2**, D6
ethylbenzene, B5, B6, **D2**, D5, **E3**, E4
ethyl-*tert*-butyl ether (ETBE), **D2**
2-ethyl-1-hexanol, **D2**
2-ethoxyethanol, **D2**, D6
2-ethoxyethyl acetate, **D2**
1-ethoxy-2-propanol, **D6**
ethrane, **L1**
ferric chloride, **H1**
filtration kit, **B4**, C1, G1
florisil, **C1**
formaldehyde, B4, **C1**
Freundlich, isotherm of -, **E1**
glass tube, **B6**
glutaric aldehyde, **C1**
graphitised charcoal, A2, **E1**
graphitised charcoal, duration and storage, **E3**
graphitised charcoal, recovery, **E6**
halothane, **L1**
n-heptane, **D2**, D6, **E3**
hexanal, B4, **C1**
n-hexane, **D2**, D6, **E3**
1-hexanol, **D2**
hydrochloridric acid, A8, **J1**
hydrofluoric acid, A8, **K1**
hydrogen sulfide, A8, **H1**
indophenol, **I1**
isobutanol, **D2**, D6
isobutyl acetate, **D2**, D6
isoflurane, **L1**
isooctane, **D2**, D6
isopentanal, B4, **C1**, C3
isopropanol, **D2**, D6



- isopropyl acetate, **D2, D6, E3**
 isopropylbenzene, **D2**
 limonene, **D2, E3**
 maintenance of radiello, **A7**
 MBTH, **G1**
 MBTH-azide, **G1**
 methanol, **D2, D6**
 2-methoxyethanol, **D2, E3**
 2-methoxyethyl acetate, **D2, E3**
 1-methoxy-2-propanol, **D2, D6, E3**
 1-methoxy-2-propyl acetate, **D2, D6**
 methyl acetate, **D2, D6**
 3-methyl-2-benzothiazolinone hydrazone (v. MBTH)
 methyl-*tert*-buthylether (MTBE), **D2**
 methylcyclohexane, **D2, D6**
 methylcyclopentane, **D2**
 methylene blue, **H1**
 methylethylketone, **D2**
 methylisobuthylketone, **D2, D6**
 methyl metacrylate, **D2**
 2-methylpentane, **D2, D6**
 3-methylpentane, **D2, D6**
 molecular sieve, **L1**
 molecular sieve, duration and storage, **L2**
 naphthalene, **D2**
 NEDA, **F2**
 nitrogen dioxide, **A8, F1**
 nitrous oxide, **L1**
 n-nonane, **D2, D6, E3**
 n-octane, **D2, D6, E3**
 ozone, **A8, C4, G1**
 ozonide, **G1**
 ozonolysis, **G1**
 pentacyanonitrosylferrate (see cyanoferrate)
 pentane, **D2, D6**
 pentanal, **B4, C1**
 permeative body, **A5, L1**
 phenol, **I1, M1**
 α -pinene, **D2, D6, E3**
 polycarbonate screw-thread cap for radiello-ready-to-use, **A8**
 polypropylene tube, **B6**
 propanal, **B4, C1**
 propyl acetate, **D2, D6**
 propylbenzene, **D2**
 4-pyridylaldehyde, **G1**
 radial diffusion, **A1, A2**
 reader for on-field thermometer, **B3**
 ready-to-use, radiello -, **A8**
 sampling, ending, **A7**
 sampling, preparing, **A6**
 sampling, sampling rate, definition, **A1**
 sampling, to start on-field, **A6**
 sevorane, **L1**
 snapping adapter, **A8**
 sodium hypochlorite, **I1**
 sterilization, **L2**
 styrene, **D2, D6, E3**
 sulphanilamide, **F2**
 shelter, **B1, B2**
 silica gel, **G1, J1**
 strip for shelter **B2, B6**
 sulfur dioxide, **A8, F1**
 supporting plate, **A5**
 Tenax TA, **M1**
 tetrachloroethylene, **D2, D6, E3**
 tetrahydrofuran, **D2**
 thermal desorption, **E1**
 thermal desorption, calibration, **E5, M4**
 thermal desorption, cartridge recovery, **E6**
 thermometer, **B3**
 thermometer, reader, **B3**
 thermometer, software, **B3**
 toluene, **B5, B6, D2, D5, E3, E4**
 1,1,1-trichloroethane, **D2, D6, E3**
 trichloroethylene, **D2, D6**
 triethanolamine, **F1**
 1,2,4-trimethylbenzene, **D2, D6, E3**
 n-undecane, **D2, D6, E3**
 using radiello, **A6**
 vertical adapter, **B1**
 volatile organic compounds, thermal desorption, **E1**
 volatile organic compounds, thermal desorption, analyses, **E4**
 volatile organic compounds, thermal desorption,
 sampling rates, **E1, E3**
 volatile organic compounds, extraction with CS₂, **D1**
 volatile organic compounds, extraction with CS₂,
 analyses, **D4**
 volatile organic compounds, extraction with CS₂,
 sampling rates, **D1, D2**
 volatile organic compounds, extraction with CS₂,
 retention times GC, **D6**
 m-xylene, **B5, B6, D2, D5, E3, E4**
 o-xylene, **B5, B6, D2, D5, E3, E4**
 p-xylene, **B5, B6, D2, D5, E3, E4**
 xylenol (see dimethylphenol)

Sigma-Aldrich Worldwide Locations

Argentina

SIGMA-ALDRICH DE ARGENTINA, S.A.
Tel: 54 11 4556 1472
Fax: 54 11 4552 1698
Email: cservice-argentina@sial.com

Australia

SIGMA-ALDRICH PTY., LIMITED
Free Tel: 1800 800 097
Free Fax: 1800 800 096
Tel: 612 9841 0555
Fax: 612 9841 0500
Email: ausmail@sial.com

Austria

SIGMA-ALDRICH HANDELS GMBH
Tel: 43 1 605 81 10 |
Fax: 43 1 605 81 20
Email: ATOOrders@europe.sial.com

Belgium

SIGMA-ALDRICH NV/SA.
Free Tel: 0800-14747Free
Fax: 0800-14745
Tel: 03 899 13 01
Fax: 03 899 13 11
Email: becustsv@europe.sial.com

Brazil

SIGMA-ALDRICH BRASIL LTDA.
Tel: 55 11 3732-3100
Fax: 55 11 3733-5151
Email: sigmabr@sial.com

Canada

SIGMA-ALDRICH CANADA LTD.
Free Tel: 800-565-1400
Free Fax: 800-265-3858
Tel: 905-829-9500
Fax: 905-829-9292
Email: canada@sial.com

China

SIGMA-ALDRICH (SHANGHAI)
Trading Co. Ltd.
Tel: +86-21-61415566
Fax: +86-21-61415567
Email: China@sial.com

Czech Republic

SIGMA-ALDRICH S.R.O.
Tel: +420 246 003 200
Fax: +420 246 003 291
Email: czeorders@europe.sial.com

Denmark

SIGMA-ALDRICH DENMARK A/S
Tel: 43 56 59 10
Fax: 43 56 59 05
Email: denorder@europe.sial.com

Finland

SIGMA-ALDRICH FINLAND
Tel: (09) 350 9250
Fax: (09) 350 9255
Email: finorder@europe.sial.com

France

SIGMA-ALDRICH CHIMIE S.À.R.L.
Tel appel gratuit: 0800 211 408
Fax appel gratuit: 0800 031 052
Email: fradsv@europe.sial.com

Germany

SIGMA-ALDRICH CHEMIE GMBH
Free Tel: 0800-51 55 000
Free Fax: 0800-649 00 00
Email: DEOrders@europe.sial.com

Greece

SIGMA-ALDRICH (O.M.) LTD
Tel: 30 210 9948010
Fax: 30 210 994383
Email: GRCustSV@europe.sial.com

Hungary

SIGMA-ALDRICH Kft
Tel: 06-1-235-9054
Fax: 06-1-269-6470
Ingyenes zöld telefon: 06-80-355-355
Ingyenes zöld fax: 06-80-344-344
Email: info@sigma.sial.hu

India

SIGMA-ALDRICH CHEMICALS
PRIVATE LIMITED
Telephone
Bangalore: 91 80 6621 9600
New Delhi: 91-11-4165-4255
Mumbai: 91-22-2570-2364
Hyderabad: +91 40 6684 5488
Fax
Bangalore: 91 80 6621 9650
New Delhi: 91-11-4165-4266
Mumbai: 91-22-2579-7589
Hyderabad: +91 40 6684 5466
Email: india@sial.com

Ireland

SIGMA-ALDRICH IRELAND LTD.
Free Tel: 1800 200 888
Free Fax: 1800 600 222
Tel: 353 1 4041900
Fax: 353 1 4041910
Email: EIOrders@europe.sial.com

Israel

SIGMA-ALDRICH ISRAEL LTD.
Free Tel: 1-800-70-2222
Tel: 08-948-4100
Fax: 08-948-4200
Email: isrtechserv@europe.sial.com

Italy

SIGMA-ALDRICH S.r.l.
Telefono: 02 33417310
Fax: 02 38010737
Numero Verde: 800-827018
Email: itclient@europe.sial.com

Japan

SIGMA-ALDRICH JAPAN K.K.
Tokyo Tel: 03 5796 7300
Tokyo Fax: 03 5796 7315
Email: sialjpts@sial.com

Korea

SIGMA-ALDRICH KOREA
Tel: 031-329-9000
Fax: 031-329-9090
Email: sakr@sial.com

Malaysia

SIGMA-ALDRICH (M) Sdn. Bhd
Tel: 603-56353321
Fax: 603-56354116
Email: sam@sial.com

Mexico

SIGMA-ALDRICH QUÍMICA, S.A. de C.V.
Free Tel: 01-800-007-5300
Free Fax: 01-800-712-9920
Email: mexico@sial.com

The Netherlands

SIGMA-ALDRICH CHEMIE BV
Tel Gratis: 0800-0229088
Fax Gratis: 0800-0229089
Tel: 078-6205411
Fax: 078-6205421
Email: nlcustsv@europe.sial.com

New Zealand

SIGMA-ALDRICH PTY., LIMITED
Free Tel: 0800 936 666
Free Fax: 0800 937 777
Tel: 61 2 9841 0500
Fax: 61 2 9841 0500
Email: ausmail@sial.com

Norway

SIGMA-ALDRICH NORWAY AS
Tel: 23 17 60 60
Fax: 23 17 60 50
Email: nororder@europe.sial.com

Poland

SIGMA-ALDRICH Sp. z o.o.
Tel: 061 829 01 00
Fax: 061 829 01 20
Email: plorders@europe.sial.com

Portugal

SIGMA-ALDRICH QUÍMICA, S.A.
Free Tel: 800 202180
Free Fax: 800 202178
Tel: 21 9242555
Fax: 21 9242610
Email: poorders@eurnotes.sial.com

Russia

SIGMA-ALDRICH RUS, LLC
Tel: +7 (495) 621-5828/5923/6037
Fax: +7 (495) 621-5828/5923/6037
Email: ruorder@sial.com

Singapore

SIGMA-ALDRICH PTE. LTD.
Tel: 65-67791200
Fax: 65-67791822
Email: sapol@sial.com

South Africa

SIGMA-ALDRICH
SOUTH AFRICA (PTY) LTD.
Free Tel: 0800 1100 75
Free Fax: 0800 1100 79
Tel: 27 11 979 1188Fax: 27 11 979 1119
Email: rsa@sial.com

Spain

SIGMA-ALDRICH QUÍMICA, S.A.
Free Tel: 900 101376
Free Fax: 900 102028
Tel: 91 661 99 77
Fax: 91 661 96 42
Email: esorders@europe.sial.com

Sweden

SIGMA-ALDRICH SWEDEN AB
Tel: 020-350510
Fax: 020-352522
Outside Sweden Tel: +46 8 7424200
Outside Sweden Fax: +46 8 7424243
Email: sweorder@europe.sial.com

Switzerland

SIGMA-ALDRICH CHEMIE GmbHSwiss
Free Call: 0800 80 00 80
Tel: +41 81 755 2828
Fax: +41 81 755 2815
Email: CHEOrders@europe.sial.com

United Kingdom

Sigma-Aldrich Company Ltd.
Free Tel: 0800 717181
Free Fax: 0800 378785
Tel: 01747 833000
Fax: 01747 833313
SAFC (UK): 01202 712305
Email: ukorders@europe.sial.com

United States

SIGMA-ALDRICH
P.O. Box 14508
St. Louis, Missouri 63178
Toll-Free: (800) 325-3010
Call Collect: (314) 771-5750
Toll-Free
Fax: (800) 325-5052
Tel: (314) 771-5765
Fax: (314) 771-5757
Email: techservice@sial.com

Internet

sigma-aldrich.com

World Headquarters

3050 Spruce St., St. Louis, MO 63103
(314) 771-5765
sigma-aldrich.com

Technical Service US: techservice@sial.com

Technical Service EUR: EurTechServ@europe.sial.com

Development/Bulk Manufacturing Inquiries (800) 244-1173



SIGMA-ALDRICH

Accelerating Customers' Success
through Leadership in Life Science,
High Technology and Service

SIGMA ALDRICH Fluka Riedel-de Haën SAFC SUPELCO ISOTEC

©2006 Sigma-Aldrich Co. All rights reserved.
SIGMA, SAFC, SAFC, SIGMA-ALDRICH, ISOTEC, ALDRICH, FLUKA, and SUPELCO are trademarks belonging to Sigma-Aldrich Co. and its affiliate Sigma-Aldrich Biotechnology, L.P. Riedel-de Haën® trademark under license from Riedel-de Haën GmbH. Sigma brand products are sold through Sigma-Aldrich, Inc. Sigma-Aldrich, Inc. warrants that its products conform to the information contained in this and other Sigma-Aldrich publications. Purchaser must determine the suitability of the product(s) for their particular use. Additional terms and conditions may apply. Please see reverse side of the invoice or packing slip.

APPENDIX C

Field Notes

297 W5THAYE

THE ACADEMY DAY CARE
COENWALL PROPERTY



Rite in the Rain[®]

ALL-WEATHER

FIELD

Nº 351FX

08/14/2022 297 W. FATH AVE NHP

0900 ARRIVE ON SITE - D. STAHL - ARES - EAU SC I
PURPOSE - MEET W. SHAWN TISDELL TO COMPLETE
ADEC BUILDING INVENTORY & INDOOR AIR
SAMPLING QUESTIONNAIRE TO EVALUATE POSSIBLE
VI FROM HISTORIC OIL/DIESEL RELEASE

0905 Shawn on site
IN CRAWL SPACE - VB ON FLOOR IN
CRAWL SPACE BUT NOT ATTACHED @
ALL EDGES
PID under VB = 0.0
PPA UNDER VB ->

CRACKS IN THE CINDER BLOCK WALL

PERMET STOVE vent directly above
forced air

MANOMETER READINGS @ Crawl space
Door: 0.2 Pa
Full communication

8/16/2022 297 W. 5th AVE N4

PPB METER READINGS - MULTI RDC
ENTRY: 400 PPB CRY. BRATED 8/16
ABOVE CRAWL SPACE - 350 PPA
IN CRAWL SPACE - 130 PPB
UNDER VB BY = 110 PPB
TRUCK LINES

Center crawl space = 190 PPB
Center under VB = 140 PPB
TEC (TIRE ENERGY COMPANY) DEE
MANOMETER

NORTH NOZZ = 280 PPB
CRAWL SPACE NOTICABLE NOX FUEL
ODORE (CLOVER)

HALL SPACE 1st floor = 480 PPB
BATHROOM Near Fuel line -> 640 PPB
Baby wipe

1125 OPPOSITE

Att: on Rain

8/19/2022 297 W 5TH AVE NP
 [0920] ARRIVE ON SITE - D. STAHL - ARES ENV. SCI
 PURPOSE: DEPLOY RADIOLLO SAMPLERS IN N+ SOUTH CRAWL SPACES

TIME	SAMPLE ID	LOCATION
0945	NJ638	CRAWL SPACE FAR END (N)
0937	NJ637	CRAWL SPACE BELOW ENTRY (SOUTH)

[0930] - ARRIVE ON SITE - D. STAHL - ARES - ENV SCI
 PURPOSE: COLLECT RADIOLLO SAMPLERS IN NORTH + SOUTH CRAWL SPACE

COLLECT TIME	SAMPLE ID	LOCATION
0950	NJ638	CRAWLSPACE FAR END (N)
0950	NJ637	CRAWLSPACE BELOW ENTRY (S)

HOBO LOGGER #1 ON N END W/ NJ638
 HOBO #2 ON S END W/ NJ637

NOTICED SCENTED CANDLE BURNING IN ENTRYWAY OFFICE

[1010] OFFSITE

APPENDIX D

Laboratory Report and ADEC Lab Checklist- 2209156

9/21/2022

Mr. Dustin Stahl

Alaska Resources & Environmental Services, LLC
3520 International St.

Fairbanks AK 99701

Project Name: 297 W 5th AVE NP

Project #: 22M-120

Workorder #: 2209156

Dear Mr. Dustin Stahl

The following report includes the data for the above referenced project for sample(s) received on 9/8/2022 at Eurofins Air Toxics LLC.

The data and associated QC analyzed by Passive S.E. RAD130/SKC are compliant with the project requirements or laboratory criteria with the exception of the deviations noted in the attached case narrative.

Thank you for choosing Eurofins Air Toxics LLC. for your air analysis needs. Eurofins Air Toxics Inc. is committed to providing accurate data of the highest quality. Please feel free to contact the Project Manager: Monica Tran at 916-985-1000 if you have any questions regarding the data in this report.

Regards,



Monica Tran

Project Manager

WORK ORDER #: 2209156

Work Order Summary

CLIENT:	Mr. Dustin Stahl Alaska Resources & Environmental Services, LLC 3520 International St. Fairbanks, AK 99701	BILL TO:	Mr. Dustin Stahl Alaska Resources & Environmental Services, LLC 3520 International St. Fairbanks, AK 99701
PHONE:	907-374-3226	P.O. #	
FAX:	907-374-3219	PROJECT #	22M-120 297 W 5th AVE NP
DATE RECEIVED:	09/08/2022	CONTACT:	Monica Tran
DATE COMPLETED:	09/21/2022		

<u>FRACTION #</u>	<u>NAME</u>	<u>TEST</u>
01A	CRAWL SPACE(S)	Passive S.E. RAD130/SKC
02A	CRAWL SPACE(N)	Passive S.E. RAD130/SKC
03A	Lab Blank	Passive S.E. RAD130/SKC
04A	CCV	Passive S.E. RAD130/SKC
05A	LCS	Passive S.E. RAD130/SKC
05AA	LCSD	Passive S.E. RAD130/SKC

CERTIFIED BY: 

 Technical Director

DATE: 09/21/22

Certification numbers: AZ Licensure AZ0775, FL NELAP – E87680, LA NELAP – 02089, NH NELAP - 209221, NJ NELAP - CA016, NY NELAP - 11291, TX NELAP - T104704434-21-17, UT NELAP – CA009332021-13, VA NELAP - 10615, WA NELAP - C935
 Name of Accreditation Body: NELAP/ORELAP (Oregon Environmental Laboratory Accreditation Program)
 Accreditation number: CA300005-015, Effective date: 10/18/2021, Expiration date: 10/17/2022.

Eurofins Air Toxics, LLC certifies that the test results contained in this report meet all requirements of the NELAC standards

This report shall not be reproduced, except in full, without the written approval of Eurofins Air Toxics, LLC.

180 BLUE RAVINE ROAD, SUITE B FOLSOM, CA - 95630
 (916) 985-1000 . (800) 985-5955 . FAX (916) 351-8279

LABORATORY NARRATIVE
RAD130 Passive SE by Mod EPA TO-17
Alaska Resources & Environmental Services, LLC
Workorder# 2209156

Two Radiello 130 (Solvent) samples were received on September 08, 2022. The laboratory analyzed the charcoal sorbent bed of the passive sampler following modified method EPA TO-17. The VOCs were chemically extracted using carbon disulfide and an aliquot of the extract was injected into a GC/MS for identification and quantification of volatile organic compounds (VOCs).

The mass of each target compound adsorbed by the sampler was converted to units of concentration using the sample deployment time and the sampling rate for each VOC. If sampling rates were calculated by the lab or the manufacturer, the concentration result has been flagged as an estimated value. Results are not corrected for desorption efficiency.

The reference method used for this procedure is EPA TO-17, which describes the collection of VOCs in ambient air using sorbents and analysis by GC/MS. Because TO-17 describes active sample collection using a pump and thermal desorption as the preparation step, several modifications are required. Modifications to TO-17 are listed in the table below:

<i>Requirement</i>	<i>TO-17</i>	<i>ATL Modifications</i>
Sample Collection	Pump pulls measured air volume through sorbent tube	VOCs in air adsorbed onto sorbent bed passively through diffusion
Sample Preparation	Thermal extraction	Solvent extraction
Sorbent tube conditioning	Condition newly packed tubes prior to use	Charcoal-based sorbent is a single use media and conditioning is conducted by vendor.
Instrumentation	Thermal desorption introduction system	Liquid injection introduction system
Internal Standard	Gas-phase internal standard introduced on the tube or focusing trap during analysis	Liquid-phase internal standard introduced on the tube at the time of extraction
Media and sample storage	<4 deg C, 30 days	Media shelf life is determined by vendor; sample hold-time is 6 months for the RAD130 and WMS. Sample preservation requirements are storage in a cool, solvent-free refrigerator and optional use of ice during shipping.
Internal Standard Recovery	+/-40% of daily CCV area	-50% to +100% of daily CCV area

Receiving Notes

There were no receiving discrepancies.

Analytical Notes

The uptake rates were corrected based on average field temperatures if provided. In the absence of field temperatures, the uptake rates determined at 25 deg C were used.

To calculate ug/m³ concentrations in the Lab Blank, a sampling duration of 20179 minutes was applied. The assumed temperature used for the uptake rate is listed on the data page. If the field temperatures were provided, the rate was adjusted in the same manner as the field samples.

If validated uptake rates were not available, rates were estimated using the chemical's diffusion coefficient in air and the geometric constant of the sampler. Chemicals that are poorly retained by the sorbent over the sampling duration may exhibit a low bias. All concentrations calculated using estimated rates are qualified with a "C" flag.

Definition of Data Qualifying Flags

Ten qualifiers may have been used on the data analysis sheets and indicate as follows:

B - Compound present in laboratory blank greater than reporting limit (background subtraction not performed).

J - Estimated value.

E - Exceeds instrument calibration range.

S - Saturated peak.

Q - Exceeds quality control limits.

U - Compound analyzed for but not detected above the reporting limit.

UJ- Non-detected compound associated with low bias in the CCV

N - The identification is based on presumptive evidence.

C - Estimated concentration due to calculated sampling rate

CN - See case narrative explanation.

File extensions may have been used on the data analysis sheets and indicates as follows:

a-File was requantified

b-File was quantified by a second column and detector

r1-File was requantified for the purpose of reissue

Summary of Detected Compounds VOCS BY PASSIVE SAMPLER - GC/MS

Client Sample ID: CRAWL SPACE(S)

Lab ID#: 2209156-01A

Compound	Rpt. Limit (ug)	Rpt. Limit (ug/m3)	Amount (ug)	Amount (ug/m3)
Hexane	0.10	0.079	0.50	0.40
Cyclohexane	0.10	0.096	27	26
Benzene	0.40	0.26	0.41	0.27
Toluene	0.10	0.070	2.4	1.7
Ethyl Benzene	0.10	0.077	0.83	0.64
m,p-Xylene	0.10	0.074	3.6	2.7
o-Xylene	0.10	0.080	1.8	1.4
Propylbenzene	0.10	0.092	0.96	0.88
Naphthalene	0.10	0.21	0.14	0.29
1,2,4-Trimethylbenzene	0.10	0.10	7.8	8.1
1,3,5-Trimethylbenzene	0.10	0.098	2.9 C	2.9 C

Client Sample ID: CRAWL SPACE(N)

Lab ID#: 2209156-02A

Compound	Rpt. Limit (ug)	Rpt. Limit (ug/m3)	Amount (ug)	Amount (ug/m3)
Hexane	0.10	0.079	1.4	1.1
Cyclohexane	0.10	0.096	86	82
Benzene	0.40	0.26	0.41	0.27
Toluene	0.10	0.070	6.1	4.3
Ethyl Benzene	0.10	0.076	1.9	1.5
m,p-Xylene	0.10	0.074	8.7	6.5
o-Xylene	0.10	0.080	3.4	2.7
Propylbenzene	0.10	0.091	1.4	1.3
Naphthalene	0.10	0.21	0.16	0.34
1,2,4-Trimethylbenzene	0.10	0.10	12	13
1,3,5-Trimethylbenzene	0.10	0.098	4.2 C	4.1 C



Air Toxics

Client Sample ID: CRAWL SPACE(S)

Lab ID#: 2209156-01A

VOCS BY PASSIVE SAMPLER - GC/MS

File Name:	c091324sim	Date of Collection:	9/2/22 9:56:00 AM
Dil. Factor:	1.00	Date of Analysis:	9/13/22 05:53 PM
		Date of Extraction:	9/13/22

Compound	Rpt. Limit (ug)	Rpt. Limit (ug/m3)	Amount (ug)	Amount (ug/m3)
Hexane	0.10	0.079	0.50	0.40
Cyclohexane	0.10	0.096	27	26
Benzene	0.40	0.26	0.41	0.27
Toluene	0.10	0.070	2.4	1.7
Ethyl Benzene	0.10	0.077	0.83	0.64
m,p-Xylene	0.10	0.074	3.6	2.7
o-Xylene	0.10	0.080	1.8	1.4
Propylbenzene	0.10	0.092	0.96	0.88
Naphthalene	0.10	0.21	0.14	0.29
1,2,4-Trimethylbenzene	0.10	0.10	7.8	8.1
1,3,5-Trimethylbenzene	0.10	0.098	2.9 C	2.9 C

C = Estimated concentration due to calculated sampling rate.

Temperature = 59.7F , duration time = 20179 minutes.

Container Type: Radiello 130 (Solvent)

Surrogates	%Recovery	Method Limits
Toluene-d8	96	70-130



Air Toxics

Client Sample ID: CRAWL SPACE(N)

Lab ID#: 2209156-02A

VOCS BY PASSIVE SAMPLER - GC/MS

File Name:	c091325sim	Date of Collection:	9/2/22 9:50:00 AM
Dil. Factor:	1.00	Date of Analysis:	9/13/22 06:19 PM
		Date of Extraction:	9/13/22

Compound	Rpt. Limit (ug)	Rpt. Limit (ug/m3)	Amount (ug)	Amount (ug/m3)
Hexane	0.10	0.079	1.4	1.1
Cyclohexane	0.10	0.096	86	82
Benzene	0.40	0.26	0.41	0.27
Toluene	0.10	0.070	6.1	4.3
Ethyl Benzene	0.10	0.076	1.9	1.5
m,p-Xylene	0.10	0.074	8.7	6.5
o-Xylene	0.10	0.080	3.4	2.7
Propylbenzene	0.10	0.091	1.4	1.3
Naphthalene	0.10	0.21	0.16	0.34
1,2,4-Trimethylbenzene	0.10	0.10	12	13
1,3,5-Trimethylbenzene	0.10	0.098	4.2 C	4.1 C

C = Estimated concentration due to calculated sampling rate.

Temperature = 60.8F , duration time = 20165 minutes.

Container Type: Radiello 130 (Solvent)

Surrogates	%Recovery	Method Limits
Toluene-d8	96	70-130



Air Toxics

Client Sample ID: Lab Blank

Lab ID#: 2209156-03A

VOCS BY PASSIVE SAMPLER - GC/MS

File Name:	c091305sim	Date of Collection:	NA
Dil. Factor:	1.00	Date of Analysis:	9/13/22 09:22 AM
		Date of Extraction:	9/13/22

Compound	Rpt. Limit (ug)	Rpt. Limit (ug/m3)	Amount (ug)	Amount (ug/m3)
Hexane	0.10	0.079	Not Detected	Not Detected
Cyclohexane	0.10	0.096	Not Detected	Not Detected
Benzene	0.40	0.26	Not Detected	Not Detected
Toluene	0.10	0.070	Not Detected	Not Detected
Ethyl Benzene	0.10	0.076	Not Detected	Not Detected
m,p-Xylene	0.10	0.074	Not Detected	Not Detected
o-Xylene	0.10	0.080	Not Detected	Not Detected
Propylbenzene	0.10	0.091	Not Detected	Not Detected
Naphthalene	0.10	0.21	Not Detected	Not Detected
1,2,4-Trimethylbenzene	0.10	0.10	Not Detected	Not Detected
1,3,5-Trimethylbenzene	0.10	0.098	Not Detected C	Not Detected C

C = Estimated concentration due to calculated sampling rate.

Temperature = 60.8F , duration time = 20179 minutes.

Container Type: Radiello 130 (Solvent)

Surrogates	%Recovery	Method Limits
Toluene-d8	94	70-130



Air Toxics

Client Sample ID: CCV

Lab ID#: 2209156-04A

VOCS BY PASSIVE SAMPLER - GC/MS

File Name:	c091302sim	Date of Collection:	NA
Dil. Factor:	1.00	Date of Analysis:	9/13/22 07:53 AM
		Date of Extraction:	NA

Compound	%Recovery
Hexane	94
Cyclohexane	99
Benzene	96
Toluene	103
Ethyl Benzene	105
m,p-Xylene	106
o-Xylene	106
Propylbenzene	110
Naphthalene	110
1,2,4-Trimethylbenzene	109
1,3,5-Trimethylbenzene	109

Container Type: NA - Not Applicable

Surrogates	%Recovery	Method Limits
Toluene-d8	102	70-130



Air Toxics

Client Sample ID: LCS

Lab ID#: 2209156-05A

VOCS BY PASSIVE SAMPLER - GC/MS

File Name:	c091303sim	Date of Collection:	NA
Dil. Factor:	1.00	Date of Analysis:	9/13/22 08:28 AM
		Date of Extraction:	9/13/22

Compound	%Recovery	Method Limits
Hexane	99	70-130
Cyclohexane	99	70-130
Benzene	88	70-130
Toluene	92	70-130
Ethyl Benzene	96	70-130
m,p-Xylene	92	70-130
o-Xylene	83	70-130
Propylbenzene	102	70-130
Naphthalene	12	5-80
1,2,4-Trimethylbenzene	88	70-130
1,3,5-Trimethylbenzene	97	70-130

Container Type: NA - Not Applicable

Surrogates	%Recovery	Method Limits
Toluene-d8	98	70-130



Air Toxics

Client Sample ID: LCSD

Lab ID#: 2209156-05AA

VOCS BY PASSIVE SAMPLER - GC/MS

File Name:	c091304sim	Date of Collection:	NA
Dil. Factor:	1.00	Date of Analysis:	9/13/22 08:55 AM
		Date of Extraction:	9/13/22

Compound	%Recovery	Method Limits
Hexane	96	70-130
Cyclohexane	103	70-130
Benzene	87	70-130
Toluene	91	70-130
Ethyl Benzene	95	70-130
m,p-Xylene	90	70-130
o-Xylene	80	70-130
Propylbenzene	98	70-130
Naphthalene	10	5-80
1,2,4-Trimethylbenzene	83	70-130
1,3,5-Trimethylbenzene	93	70-130

Container Type: NA - Not Applicable

Surrogates	%Recovery	Method Limits
Toluene-d8	97	70-130

Laboratory Data Review Checklist for Air Samples

Completed By:

Dustin Stahl

Title:

Environmental Specialist

Date:

10/05/2022

Consultant Firm:

Alaska Resources and Environmental Services

Laboratory Name:

Eurofins Air Toxics Folsom CA

Laboratory Report Number:

2209156

Laboratory Report Date:

09/21/20

CS Site Name:

297 West 5th Avenue North Pole, AK

ADEC File Number:

100.38.216

Hazard Identification Number:

4439

2209156

Laboratory Report Date:

09/21/20

CS Site Name:

297 West 5th Avenue North Pole, AK

Note: Any N/A or No box checked must have an explanation in the comments box.

1. Laboratory

a. Did an ADEC CS approved laboratory receive and perform all of the submitted sample analyses?

Yes No N/A Comments:

b. If the samples were transferred to another “network” laboratory or sub-contracted to an alternate laboratory, was the laboratory performing the analyses ADEC CS approved?

Yes No N/A Comments:

The samples were not transferred or subcontracted.

2. Chain of Custody (CoC)

a. CoC information completed, signed, and dated (including released/received by)?

Yes No N/A Comments:

The COC was not included in the laboratory report. It was signed when the samples were released/shipped.

b. Correct analyses requested?

Yes No N/A Comments:

3. Laboratory Sample Receipt Documentation

a. Sample condition documented - Samples collected in gas tight, opaque/dark Summa canisters or other ADEC approved container? Canister vacuum/pressure checked, recorded upon receipt and contained no open valves?

Yes No N/A Comments:

Air samples were collected by Passive adsorption samplers.

b. If there were discrepancies, were they documented? For example, incorrect sample containers, insufficient or missing samples, canister not holding a vacuum etc.?

Yes No N/A Comments:

There were no discrepancies.

2209156

Laboratory Report Date:

09/21/20

CS Site Name:

297 West 5th Avenue North Pole, AK

c. Data quality or usability affected?

Comments:

N/A- There were no discrepancies.

4. Case Narrative

a. Present and understandable?

Yes No N/A Comments:

b. Discrepancies, errors, or QC failures identified by the lab?

Yes No N/A Comments:

There were no discrepancies, errors, or QC failures.

c. Were all corrective actions documented?

Yes No N/A Comments:

There were no discrepancies, errors, or QC failures.

d. What is the effect on data quality/usability according to the case narrative?

Comments:

N/A-There were no discrepancies, errors, or QC failures.

5. Samples Results

a. Correct analyses performed/reported as requested on COC?

Yes No N/A Comments:

b. All applicable holding times met?

Yes No N/A Comments:

2209156

Laboratory Report Date:

09/21/20

CS Site Name:

297 West 5th Avenue North Pole, AK

c. Are the reported LOQs less than the target level or screening level for the project, as defined in the approved work plan?

Yes No N/A Comments:

d. Data quality or usability affected?

N/A

6. QC Samples

a. Method Blank

i. One method blank reported per matrix, analysis and 20 samples?

Yes No N/A Comments:

ii. All method blank results less than limit of quantitation (LOQ) or project specified objectives?

Yes No N/A Comments:

All method blank results were non-detect.

iii. If above LOQ or project specified objectives, what samples are affected?

Comments:

N/A- All method blank results were non-detect.

iv. Do the affected sample(s) have data flags? If so, are the data flags clearly defined?

Yes No N/A Comments:

All method blank results were non-detect.

v. Data quality or usability affected?

Comments:

N/A- All method blank results were non-detect.

2209156

Laboratory Report Date:

09/21/20

CS Site Name:

297 West 5th Avenue North Pole, AK

b. Laboratory Control Sample/Duplicate (LCS/LCSD)

i. Organics – One LCS/LCSD reported per matrix, analysis and 20 samples?

Yes No N/A Comments:

ii. Accuracy – All percent recoveries (%R) reported and within method or laboratory limits and project specified objectives, if applicable?

Yes No N/A Comments:

All %R were within control limits.

iii. Precision – All relative percent differences (RPD) reported and less than method or laboratory limits and project specified objectives, if applicable?

Yes No N/A Comments:

All RPDs were within control limits.

iv. If %R or RPD is outside of acceptable limits, what samples are affected?

Comments:

N/A- All %R and RPDs were within control limits.

v. Do the affected sample(s) have data flags? If so, are the data flags clearly defined?

Yes No N/A Comments:

vii. Data quality or usability affected? (Use comment box to explain.)

Comments:

N/A- All %R and RPDs were within control limits.

c. Surrogates – VOCs only

i. Are surrogate recoveries reported for VOC analyses – field, QC and laboratory samples?

Yes No N/A Comments:

2209156

Laboratory Report Date:

09/21/20

CS Site Name:

297 West 5th Avenue North Pole, AK

ii. Accuracy – All percent recoveries (%R) reported and within method or laboratory limits and project specified objectives, if applicable?

Yes No N/A Comments:

All %R were within control limits.

iii. Do the sample results with failed surrogate recoveries have data flags? If so, are the data flags clearly defined?

Yes No N/A Comments:

All %R were within control limits.

iv. Data quality or usability affected?

Comments:

N/A-All %R were within control limits.

d. Field Duplicate

i. One field duplicate submitted per matrix, analysis and 10 project samples?

Yes No N/A Comments:

A field duplicate was not required for this sampling event.

ii. Submitted blind to lab?

Yes No N/A Comments:

iii. Precision – All relative percent differences (RPD) less than specified project objectives? (Recommended: 30% air)

$$RPD (\%) = \text{Absolute value of: } \frac{(R_1 - R_2)}{((R_1 + R_2) / 2)} \times 100$$

Where R₁ = Sample Concentration
R₂ = Field Duplicate Concentration

Yes No N/A Comments:

2209156

Laboratory Report Date:

09/21/20

CS Site Name:

297 West 5th Avenue North Pole, AK

iv. Data quality or usability affected? (Use the comment box to explain why or why not.)

Comments:

N/A

e. Field Blank (If not applicable, a comment stating why must be entered below)?

Yes No N/A Comments:

A field blank was not required for this sampling event.

i. All results less than LOQ and project specified objectives?

Yes No N/A Comments:

ii. If above LOQ or project specified objectives, what samples are affected?

Comments:

N/A

iii. Data quality or usability affected?

Comments:

N/A

7. Other Data Flags/Qualifiers (ACOE, AFCEE, Lab Specific, etc.)

a. Defined and appropriate?

Yes No N/A Comments:

APPENDIX E

ADEC Building Inventory and Indoor Air Sampling Questionnaire

ALASKA DEPARTMENT OF ENVIRONMENTAL CONSERVATION
BUILDING INVENTORY AND INDOOR AIR SAMPLING QUESTIONNAIRE

This form should be prepared by a person familiar with indoor air assessments with assistance from a person knowledgeable about the building. Complete this form for each building in which interior samples (e.g., indoor air, crawl space, or subslab soil gas samples) will be collected. Section I of this form should be used to assist in choosing an investigative strategy during work-plan development. Section II should be used to assist in identification of complicating factors during a presampling building walkthrough.

Preparer's Name DUSTIN STAHL Date/Time Prepared 08/16/2022
Preparer's Affiliation ARES Phone No. 907 374 3220
Purpose of Investigation AIR INTRUSION - POSSIBLE VAPORS FROM HISTORIC DIESEL RELEASES

SECTION I: BUILDING INVENTORY

1. OCCUPANT OR BUILDING PERSONNEL: (DAY CARE SUPERVISOR)

Interviewed: Y / N

Last Name ~~MACABEE~~ MACABEE First Name BRECKO

Address _____

County _____

Phone No. 907 385 0311

Number of Occupants/persons at this location _____ Age of Occupants _____

2. OWNER or LANDLORD: (Check if same as occupant _____)

Interviewed: Y / N

Last Name CORNWALL First Name DAVID

Address 607 OLD STEESE HIGHWAY SUITE B

County FAIR BANKS, AK 99701

Phone No. _____

3. BUILDING CHARACTERISTICS

Type of Building: (Circle appropriate response)

Residential
Industrial

School
Church

Commercial/Multi-use

Other DAYCARE

If the property is residential, type? (Circle appropriate response) N/A COMMERCIAL DAY CARE

- | | | |
|--------------|-----------------|-------------------|
| Ranch | 2-Family | 3-Family |
| Raised Ranch | Split Level | Colonial |
| Cape Cod | Contemporary | Mobile Home |
| Duplex | Apartment House | Townhouses/Condos |
| Modular | Log Home | Other _____ |

If multiple units, how many? N/A

If the property is commercial, type?

Business Types(s) CHILD DAYCARE FACILITY

Does it include residences (i.e., multi-use)? Y N If yes, how many? N/A

Other characteristics:

Number of floors 1 + CRAWL SPACE Building age _____

Is the building insulated? Y / N How air tight? Tight / Average / Not Tight

Have occupants noticed chemical odors in the building? Y N

If yes, please describe: |

4. AIRFLOW

Use air current tubes, tracer smoke, or knowledge about the building to evaluate airflow patterns and qualitatively describe:

Airflow between floors MANOMETER USED @ CRAWLSPACE ACCESS W (SOUTH END)
VIRTUALLY NO DIFFERENCE IN PRESSURE. FULL COMMUNICATION PATHWAY AT THIS LOCATION

Airflow in building near suspected source
SEE ABOVE

Outdoor air infiltration
IN CRAWL SPACE MULTIPLE PENETRATIONS FOR ~~OFF~~ Fuel lines + Piping that are NOT SEALED W AIR FLOWING IN

Infiltration into air ducts NOT EVALUATED

5. BASEMENT AND CONSTRUCTION CHARACTERISTICS (Circle all that apply)

- a. Above grade construction: wood frame log concrete brick
 constructed on pilings with enclosed air space constructed on pilings with open air space
- b. Basement type: full crawlspace slab-on-grade other _____
- c. Basement floor: concrete dirt stone other COVERED w 10 MIL VB
- d. Basement floor: unsealed sealed sealed with VB w/Tremco Poor Attachment
- e. Foundation walls: poured + block stone other _____
- f. Foundation walls: unsealed sealed sealed with _____
- g. The basement is: wet damp dry w/ Puddles on + under VB
- h. The basement is: finished unfinished partially finished
- i. Sump present? Y (N)
- j. Water in sump? Y (N) not applicable

Basement/Lowest level depth below grade 6 (feet)

Identify potential soil vapor entry points and approximate size (e.g., cracks, utility ports, drains)

CRACKS IN CINDER BLOCK WALLS, FUEL LINE + UTILITY penetrations, DIRT FLOOR (UNSEALED AREAS OF VB)

6. HEATING, VENTING and AIR CONDITIONING (Circle all that apply)

Type of heating system(s) used in this building: (Circle all that apply - not primary)

- SOUTH NORTH
 Hot air circulation Heat pump Hot water baseboard
 Space Heaters Stream radiation Radiant floor
 Electric baseboard Wood stove Outdoor wood boiler Other _____

The primary type of fuel used is:

- WOOD PELLETS Fuel Oil NORTH BOILER
 Natural Gas Kerosene
 Electric Propane Solar
 Coal

Domestic hot water tank fueled by SOUTH END FORCED AIR BOILER? and/or electric?

Boiler/furnace located in: Basement Outdoors Main Floor Other _____

Do any of the heating appliances have cold-air intakes? Y (N)

Type of air conditioning or ventilation used in this building:

NONE

IN BUILDING FOOT PRINT w/ accesses only from OUT SIDE ON EAST SIDE OF BUILDING

Central Air

Window units

Open Windows

None

Commercial HVAC

Heat-recovery system

Passive air system

Are there air distribution ducts present?

Y/N FOR WOOD PELLET FURNACE

Describe the ventilation system in the building, its condition where visible, and the tightness of duct joints. Indicate the locations of air supply and exhaust points on the floor plan.

NOT EVALUATED

Is there a radon mitigation system for the building/structure? Y/N Date of Installation _____

Is the system active or passive? Active/Passive N/A

7. OCCUPANCY

Is basement/lowest level occupied? Full-time Occasionally Seldom Almost Never

Level General Use of Each Floor (e.g. family room, bedroom, laundry, workshop, storage)

Basement UTILITY ACCESS & MAINTENANCE

1st Floor CHILD DAY CARE FACILITY

2nd Floor NONE

3rd Floor NONE

8. WATER AND SEWAGE

Water Supply: Public Water Drilled Well Driven Well Dug Well Other _____

Sewage Disposal: Public Sewer Septic Tank Leach Field Dry Well Other _____

9. FLOOR PLANS

Draw a plan view sketch of the basement and first floor of the building. Indicate air sampling locations, possible indoor air pollution sources and PID meter readings. If the building does not have a basement, please note.

Basement:

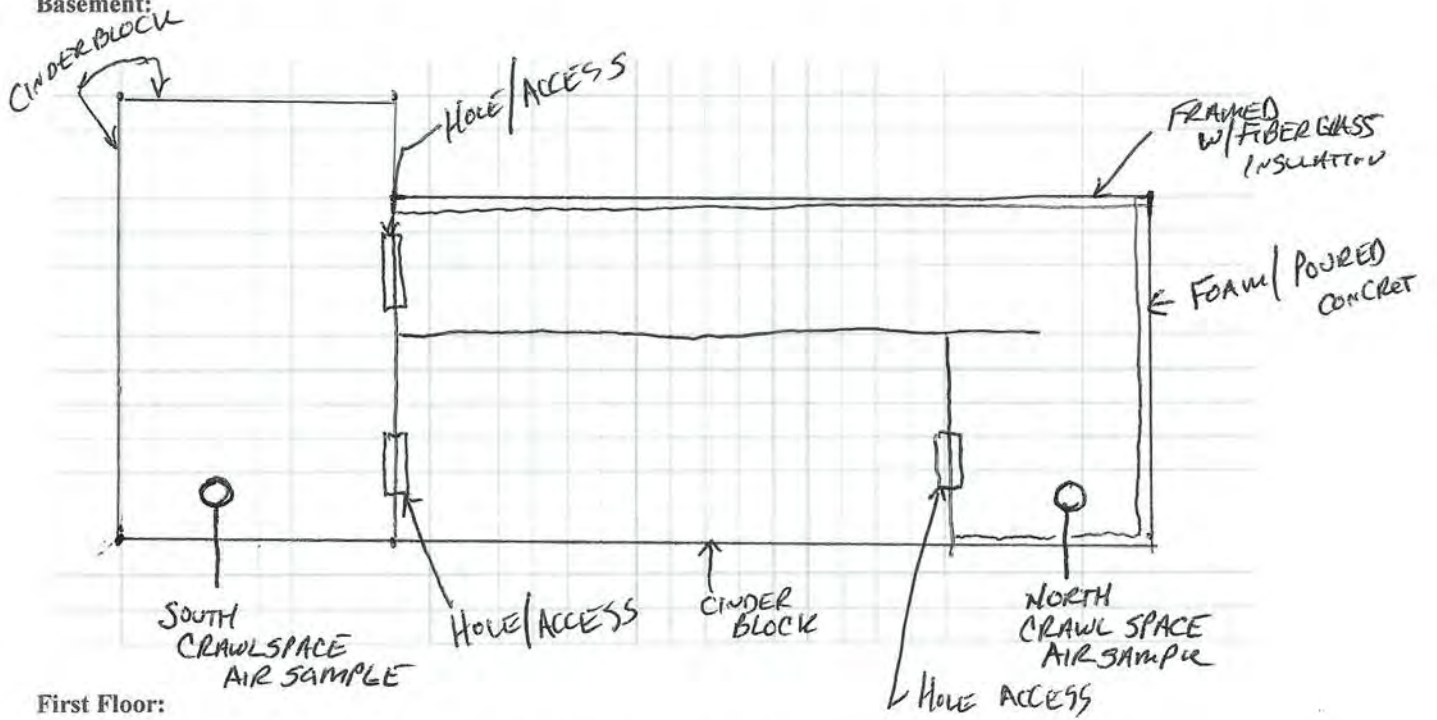

First Floor:

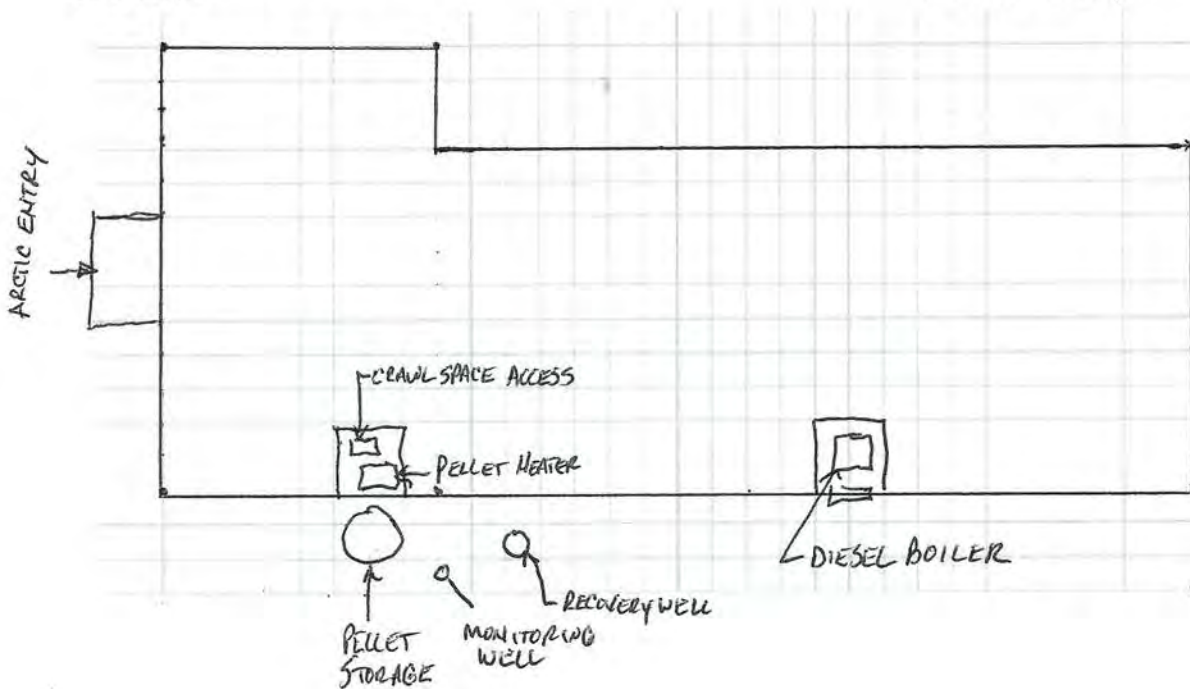

10. OUTDOOR PLOT

Draw a sketch of the area surrounding the building being sampled. If applicable, provide information on spill locations, potential air contamination sources (industries, gas stations, repair shops, landfills, etc.), outdoor air sampling location(s) and PID meter readings.

Also indicate compass direction, wind direction and speed during sampling, the locations of the well and septic system, if applicable, and a qualifying statement to help locate the site on a topographic map.

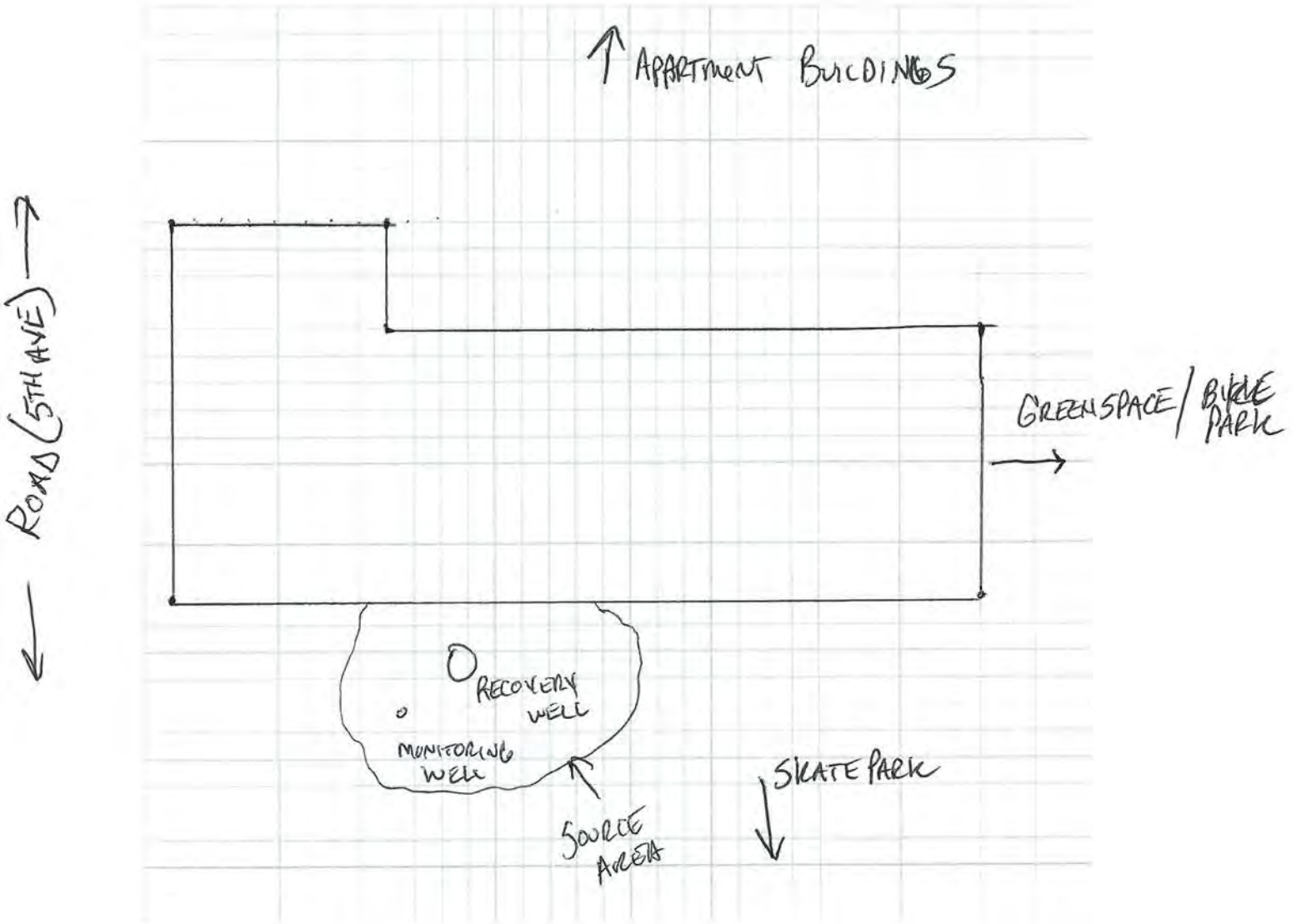

SECTION II: INDOOR AIR SAMPLING QUESTIONNAIRE

This section should be completed during a presampling walkthrough. If indoor air sources of COCs are identified and removed, consider ventilating the building prior to sampling. However, ventilation and heating systems should be operating normally for 24 hours prior to sampling.

a) 1. FACTORS THAT MAY INFLUENCE INDOOR AIR QUALITY

- Is there an attached garage? Y N
- Does the garage have a separate heating unit? Y / N NA
- Are petroleum-powered machines or vehicles stored in the garage (e.g., lawnmower, ATV, car) Y / N NA
Please specify _____
- Has the building ever had a fire? Y N When? _____
- Is a kerosene or unvented gas space heater present? Y N Where? _____
- Is there a workshop or hobby/craft area? Y N Where & Type _____
- Is there smoking in the building? Y N How frequently? _____
- Has painting/staining been done in the last 6 months? Y N Where & When? _____
- Is there new carpet, drapes or other textiles? Y N Where & When? _____
- Is there a kitchen exhaust fan? Y N If yes, where vented? _____
- Is there a bathroom exhaust fan? Y / N If yes, where vented? _____
- Is there a clothes dryer? Y N If yes, is it vented outside? Y / N

Are cleaning products, cosmetic products, or pesticides used that could interfere with indoor air sampling? Y / N

If yes, please describe LOTS OF SANITIZER, + CLEANING PRODUCTS
TO CLEAN UP FOR KIDS

Do any of the building occupants use solvents at work? Y N

(e.g., chemical manufacturing or laboratory, auto mechanic or auto body shop, painting, fuel oil delivery, boiler mechanic, pesticide application, cosmetologist)

If yes, what types of solvents are used? N/A

If yes, are their clothes washed at work? Y / N

Do any of the building occupants regularly use or work at a dry-cleaning service? (Circle appropriate response)

Yes, use dry-cleaning regularly (weekly)

No

Yes, use dry-cleaning infrequently (monthly or less)

Unknown

Yes, work at a dry-cleaning services

