

Treadwell Mining Complex

HISTORIC RESOURCES AND SITE SURVEY REPORT



City and Borough of Juneau
Wayne Jensen: Jensen Yorba Lott, Inc.
August 2010

TABLE OF CONTENTS

Acknowledgements

Introduction

Purpose and Context

Historical Significance

Historical Context

Architectural Summary

Site and Vicinity Maps

Treadwell Historic District

Key Map

Page 12	5- Stamp Mill
Page 14	300 Mill and Vanner Room
Page 19	Central Power Plant
Page 23	Tennis Court
Page 26	Superintendent's House
Page 30	Assistant Superintendent's House
Page 32	Treadwell Plaza
Page 35	Barn
Page 37	Store and Butcher Shop
Page 44	New Office Building
Page 50	Assay Office
Page 53	School House
Page 55	Wharf and Warehouses
Page 60	Pump House
Page 62	Boarding House
Page 65	Dormitories
Page 69	Treadwell Club
Page 74	Natatorium
Page 77	Cottages (Treadwell Heights)
Page 77	Cottages (Campbell Hill)
Page 80	Central Hoist and Crushing Plant
Page 87	240 Mill
Page 90	Treadwell Hoist
Page 92	Blacksmith Shop
Page 96	Glory Hole
Page 98	Tanks
Page 102	Water System (Treadwell Ditch)
Page 106	Cave-in Site

Bibliography

ACKNOWLEDGEMENTS

This publication was prepared on behalf of the City and Borough of Juneau, Department of Community Development by Wayne Jensen, Architect of Jensen Yorba Lott, Inc. and based in part on previous work completed by Architect Gary Gillette.

The research for this publication has been financed in part with Federal funds from the National Park Service, Department of the Interior, and through the assistance of the Office of History and Archaeology, Department of Natural Resources. However, the contents and opinions expressed do not necessarily reflect the views or policies of the Department of the Interior or the Department of Natural Resources, nor does the mention of trade names or commercial products constitute and endorsement or recommendation by the Department of the Interior or the Department of Natural Resources.

Current photos provided by Wayne Jensen. Historical photos provided courtesy of the Alaska State Historical Library and the Juneau Douglas City Museum.

Historical drawings of the Treadwell Mining Complex were provided courtesy of the Alaska State Historical Library, AJT Mining Properties, the Sanborn Library, LLC. and the City and Borough of Juneau.

City and Borough of Juneau Historic Resources Advisory Committee

Steven Winkler , Chair

Gerald Gotschall, Vice Chair

Shauna McMahan, Secretary

Marie Darlin

Gary Gillette

Myra Gilliam

Rico Worl

Larry Hayden

Connie Munro

Treadwell Historic Preservation and Restoration Society, Inc.

Paulette Simpson , President

Rich Poor, Vice President

Catherine Johnson, Secretary

Gary Gillette, Treasurer

John Delgado, Director

Jim Geraghty, Director

Jerry Harmon, Director

City and Borough of Juneau Assembly

Bruce Botelho, Mayor

Robert Doll

Johan Dybdahl

Jeff Bush

Merrill Sanford

David Stone

Randy Wanamaker

Jonathan Anderson

Ruth Danner

Cover Photo Credit: Alaska State Library

INTRODUCTION

Gold was known to exist in Alaska in the creeks tributary to Windham Bay and Sumdum (approximately 60 miles south of Juneau) as early as the late 1860's, but major placer mining did not take place until the 1870's. A string of highly mineralized deposits along the coastline extending from Windham Bay north to Berners Bay became known as the Juneau Gold Belt. Gold Creek and Douglas Island received the most development of the six districts in the Juneau Gold Belt.

The generally recognized Alaskan "gold rush" began in 1897, 27 years after gold was discovered in Southeast Alaska. The stampede of fortune hunters only passed through Alaska on their way to the gold fields of the Yukon. Skagway provided the supply center and the famous Chilkoot Trail was the route to the Yukon. Less publicized Alaskan "gold rushes" in the early 1900's occurred within the Juneau Gold Belt and the Willow Creek district lying approximately 40 air miles north of Anchorage.

Small hard rock gold mines occurred in other parts of Alaska including the Fairbanks district but clearly the Juneau Gold Belt was the leader. And the Treadwell Complex operation was ranked as the world's largest during the period from 1911 to 1917.

In the spring of 1881 the French Canadian prospector, Pierre Joseph Erussard discovered gold on Douglas Island. Later that year he sold his claim to John Treadwell for \$400. Treadwell set up a five stamp test mill in 1882 and organized the Alaska Mill and Mining Company along with John Fry, a banker from San Francisco and James Freeborn, a friend of Fry's. Upon successful demonstration by the five stamp mill a 120 stamp mill was constructed and up and running by 1884. In 1889 the Alaska Mill and Mining Company became the Alaska Treadwell Gold Mining Company which also managed the Alaska Mexican and Alaska United gold mines.

In 1900, F.W. Bradley came to Juneau as president of the Alaska Juneau Gold Mining Company and took over as president of the Alaska Treadwell in 1911. Bradley was a well known and respected mining engineer who specialized in low cost mining and milling processes. Through his perfection of the mining and milling techniques, Bradley was able to increase the profits from the Treadwell operation. During the years from 1911 through 1917 the Treadwell Complex set world records for low cost mining and ranked as the world's largest.

On April 21, 1917 a sea level cave-in occurred and flooded the bulk of the Treadwell mines. The Ready Bullion mine continued until the end of 1922 at which time the entire Treadwell Complex ceased operations except for the foundry. In 1928 the Alaska Juneau Mining Company purchased the entire Treadwell Complex mining properties.

Today there remains extant and collapsed buildings, structures, objects and sites throughout the Treadwell properties which provide evidence of the great mining operations from 1881 to 1922. Most of the Treadwell property is privately owned by AJT Mining Properties, Inc. and a small portion is owned by the City and Borough of Juneau. The portion owned by the City and Borough of Juneau is the focus of this survey.

In 2009, the Treadwell Historic Preservation and Restoration Society was formed as a non profit corporation and a Memorandum of Agreement was made between the Society and the City and borough of Juneau granting the Society the right to manage the Property for public use.

PURPOSE AND CONTEXT

The purpose of the Treadwell Mining Complex and Site Survey Report is to survey the property and structures owned by the City and Borough of Juneau that are part of the Historic Treadwell Mining Complex as outlined by the yellow and black lines on the aerial photo below.

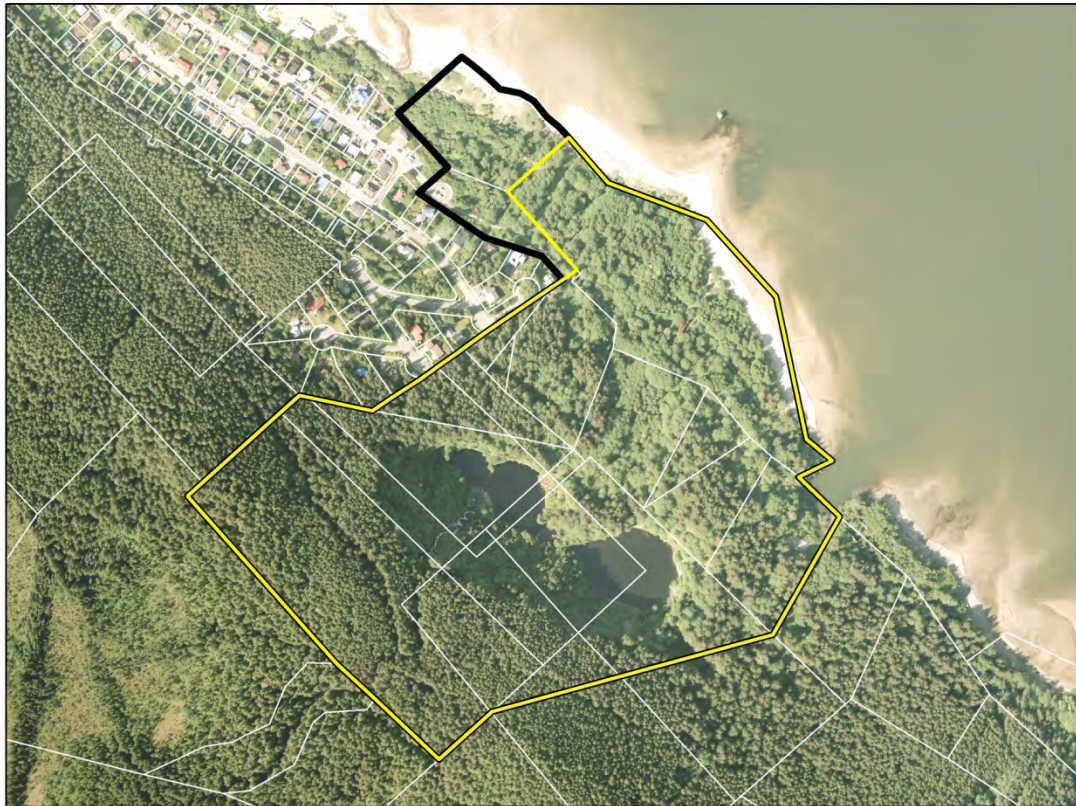

The survey included updating the *Draft Historic Resources Survey, 1991* for the structures located within the study area. It also included researching maps, photos and building drawings from the initial development of the mining area to approximately 1917 when the cave-in ended production of 3 of the 4 mines in the complex. Documenting the current condition of the buildings, structures and sites as well as the historic description is included. The report concludes with Best Management Practices to protect and preserve historical archaeological resources.

The following General Surface Map, Treadwell Group of Mines, 1913, illustrates the extent of the Treadwell Mining Complex and the portion included in this survey.

HISTORICAL SIGNIFICANCE

Seventeen years before the famed Klondike Gold Rush of 1898, John Treadwell arrived on the shores of Gastineau Channel to look over possible mining prospects in Juneau and on Douglas Island.

Treadwell's first claim was for the Paris lode on Douglas Island which was purchased from Pierre Joseph Erussard in 1881. In December of 1881, Treadwell returned to Douglas and purchased two more lode claims. He took samples from the claims to San Francisco where they were tested. The samples proved to be quite rich which enabled Treadwell to secure investors in his claim. The new partnership was known as the Alaska Mill and Mining Company. It was at this time that Treadwell purchased a 5 stamp mill to process the ore. Treadwell soon learned that the vein was much larger than he anticipated. He quickly purchased adjacent claims and expanded his operations. Treadwell soon bought out his partners and formed the Treadwell Gold Mines. The 5 stamp mill was replaced by a 120 stamp mill in 1883 and another 120 stamps were added in 1887.

The Treadwell Mining Complex was ultimately composed of four different mines: Treadwell, Ready Bullion, Mexican and 700'. At the height of their glory, the mines employed over 2000 people.

The communities of Douglas and Treadwell were founded to house the miners and their families. In the Treadwell heydays the communities were among the most populous in Alaska and amenities offered Treadwell employees and their families were abundant.

The Treadwell Complex soon became the largest gold mine in the world and over the course of its lifespan produced approximately \$66 million dollars of gold.

John Treadwell sold his interest in the company for a reported \$1.5 million in 1898. The mines continued to produce until a disastrous cave-in in 1917 which collapsed all but the Ready Bullion Mine which continued to produce until 1922.

Following the cave-in Treadwell slowly died and now all that remains are remnants and artifacts of this once vibrant place that embodies the gold rush era of Alaska.

The remains of the Treadwell Mining Complex offer an insight into the mining history of the Juneau-Douglas area and the magnitude of the industry in the late 19th and early 20th centuries. Today the area is a popular recreation area with a network of trails.

The remains of the buildings and structures provide the CBJ the opportunity to preserve for current and future generations the mine site, and to make available for observation, inspiration and enjoyment, an accurate portrayal of the scale of the operation and the story that unfolded at Treadwell.

HISTORICAL CONTEXT

The great California rush of 1848 brought people from all over the world to America to make their fortunes. As placer gold claims were exhausted prospectors migrated on to the next reported gold strike. In the 1870's these motivated miners made their way to Southeast Alaska.

It was in 1880 that prospectors Richard Harris and Joe Juneau staked their claims on Gold Creek and formed the town of Harrisburgh (later changed to Rockwell and ultimately to Juneau). Their claims sparked the first Alaska gold rush.

Word of the gold rush reached San Francisco and a group of mining investors sent John Treadwell north to investigate in 1881. He soon purchased claims on Douglas Island and returned to San Francisco with samples of ore that showed promise. In 1882, Treadwell returned to Douglas with a 5 stamp mill and purchased adjoining claims, thus sparking the development of the communities of Treadwell and Douglas.

In 1889, the Alaska Treadwell Gold Mining Company bought out all of its investors including John Treadwell.

In the early 1890's two mining companies financed by the Treadwell Company were incorporated, the Alaska Mexican Gold Mining Company and the Alaska United Gold Mining Company. Each company was financially separate but the Treadwell Company managed all of them.

Mining at Treadwell began with open-pit mining of ore in the area of the current Glory Hole. The operation soon evolved into underground mining of the ore contained in the solid rock with some of the workings reaching 2300 feet below sea level.

The Treadwell mines employed highly advanced technologies for their era and pioneered the modern mining industry. The use of hydroelectricity converted steam powered equipment to more economical electric power. World famous mining engineer Frederick Bradley guided the development of the Treadwell mines as the complex grew into the largest gold mine in the world.

From the efforts of a single man that was John Treadwell, grew a world famous mining and milling operation known as the Treadwell, its legend lives on in the mining community.

Following the 1917 cave-in the population of Treadwell and Douglas slowly dwindled as miners moved across the channel to Juneau seeking work in the AJ Mine or returned to their roots elsewhere. Treadwell was eventually abandoned in its entirety.

Unequivocally, mining was the catalyst for the development and eventual dissolution of the Treadwell Complex, but the story remains an integral part of Alaska history.

TREADWELL HISTORIC DISTRICT

Key Plan

The following map is the key to the location of the resources include in this survey.

Key Map
Treadwell Historic District

1. 5-Stamp Mill
2. 300 Mill and Vanner Room
3. Central Power Plant
4. Tennis Court
5. Superintendent's House
6. Assistant Superintendent's House
7. Treadwell plaza
8. Barn
9. Store and Butcher Shop
10. New Office Building
11. Assay Office
12. School House
13. Wharf and Warehouses
14. Pump House
15. Boarding House
16. Dormitories
17. Treadwell Club
18. Natatorium
19. Cottages (Treadwell Heights)
20. Cottages (Campbell Hill)
21. Central Hoist and Crushing Plant
22. 240 Mill
23. Treadwell Hoist
24. Blacksmith Shop
25. Glory Hole
26. Tanks
27. Water System
28. Cave-in Site

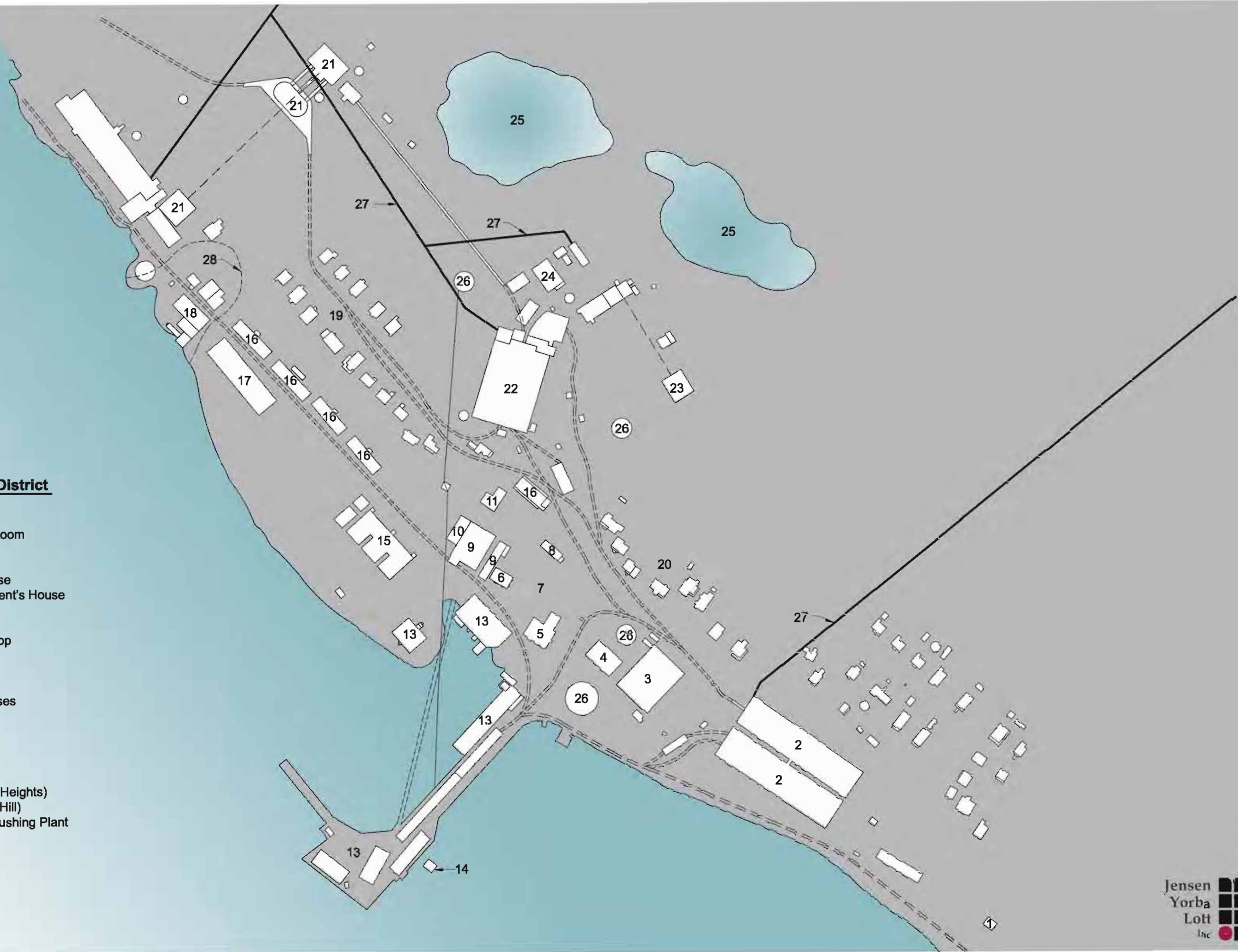

TREADWELL HISTORIC DISTRICT

5 STAMP MILL

Five Stamp Mill prior to restoration

Photo courtesy of Juneau Douglas City Museum



Five Stamp Mill marking beginning of historic Treadwell Trail, June 2010

Photo courtesy of Wayne Jensen



TREADWELL HISTORIC DISTRICT

300 STAMP MILL



Alaska State Library - Historical Collections

300 Stamp Mill

Alaska State Library, Alaska Juneau Gold Mining Company Records, ASL-M999-T7-1

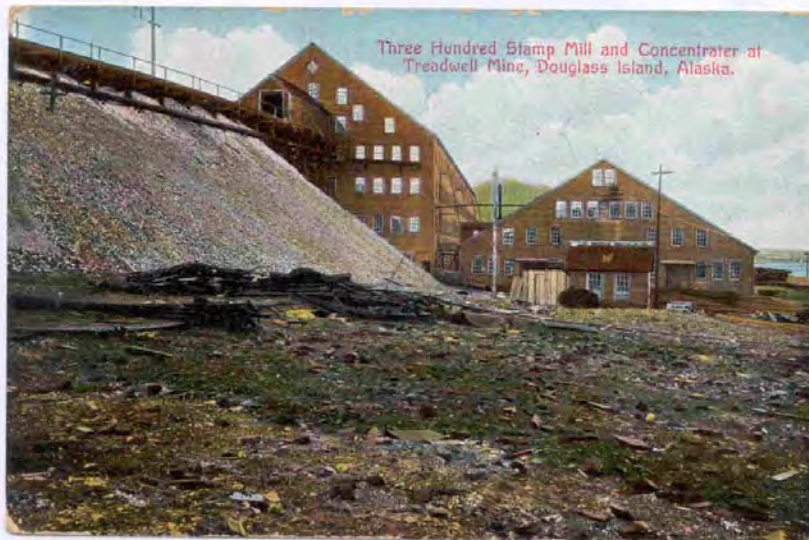

300 Stamp Mill and Concentrator

Photo Courtesy of Juneau Douglas City Museum

TREADWELL HISTORIC DISTRICT

300 STAMP MILL



Alaska State Library - Historical Collections

Vanner Room, 300 Stamp Mill

Alaska State Library, Case & Draper Collection, ASL-P39-0924



Vanner Roll remains, 300 Stamp Mill - July 2010

Photo Courtesy of Wayne Jensen

TREADWELL HISTORIC DISTRICT

300 STAMP MILL

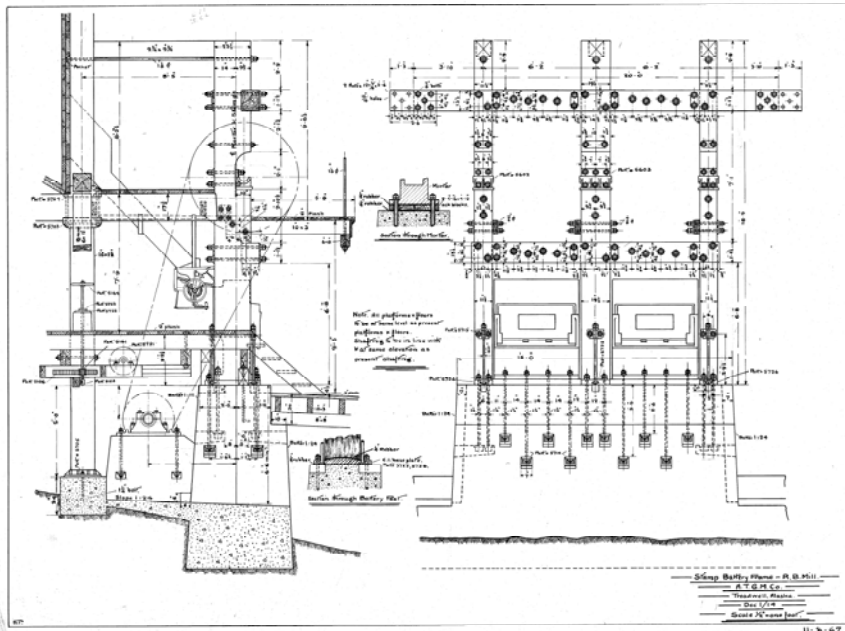

Stamp Battery from Ready Bullion Mine, similar to the ones at the 300 Stamp Mill
Drawing Courtesy of Alaska State Library Historical Collections, AJT Collection



Foundations from the 300 Stamp Mill, November 2009
Photo courtesy of Wayne Jensen

TREADWELL HISTORIC DISTRICT

300 STAMP MILL

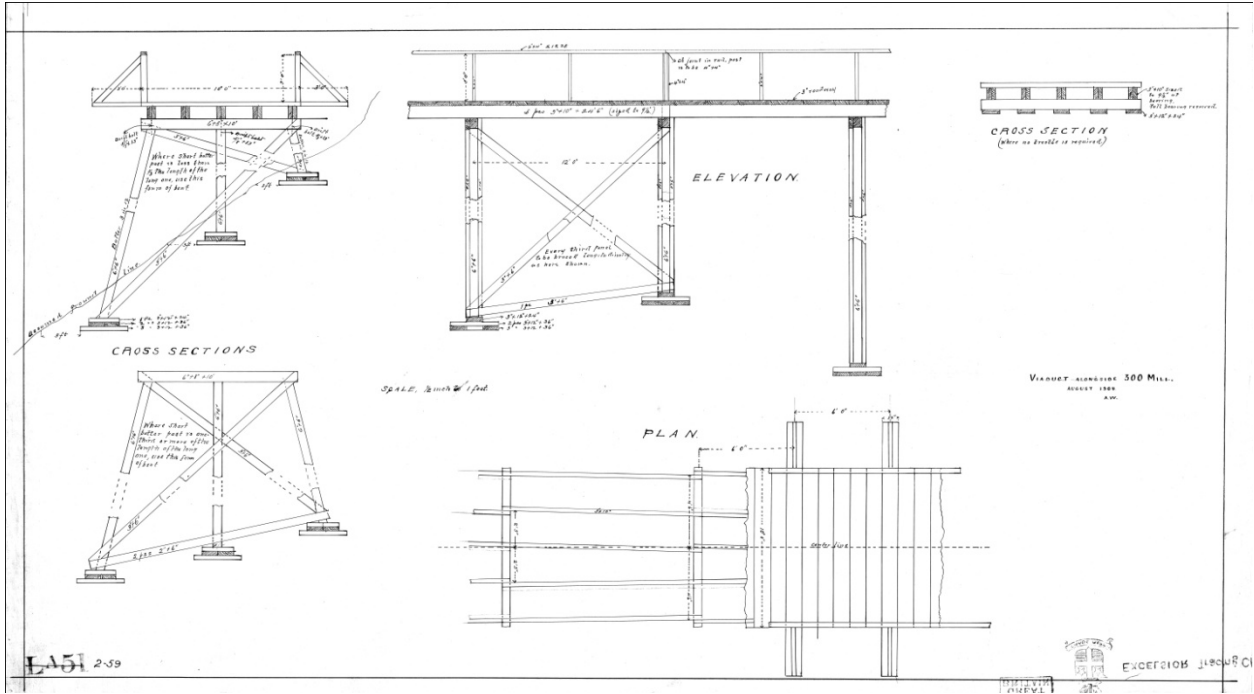

Ore Train Trestle to 300 Stamp Mill

Drawing courtesy of Alaska State Library Historical Collections, AJT Collection

TREADWELL HISTORIC DISTRICT

CENTRAL POWER PLANT

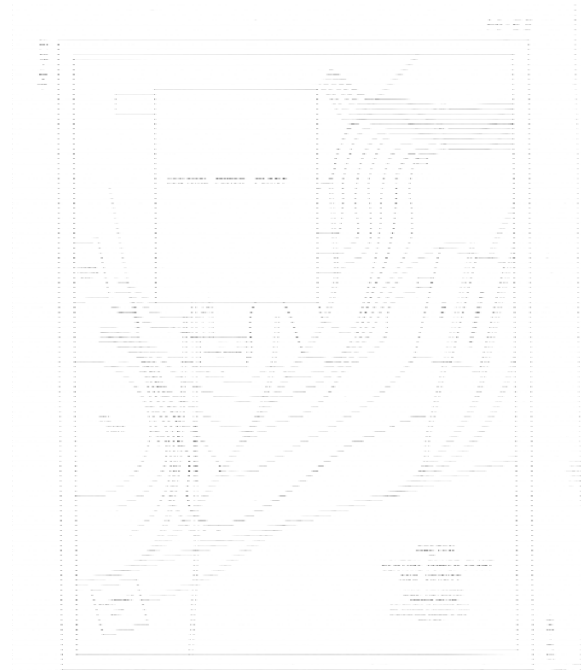

Sketch of Central Power Plant and Vicinity, September 1915
Drawing courtesy of Alaska State Library Historical Collections, AJT Collection

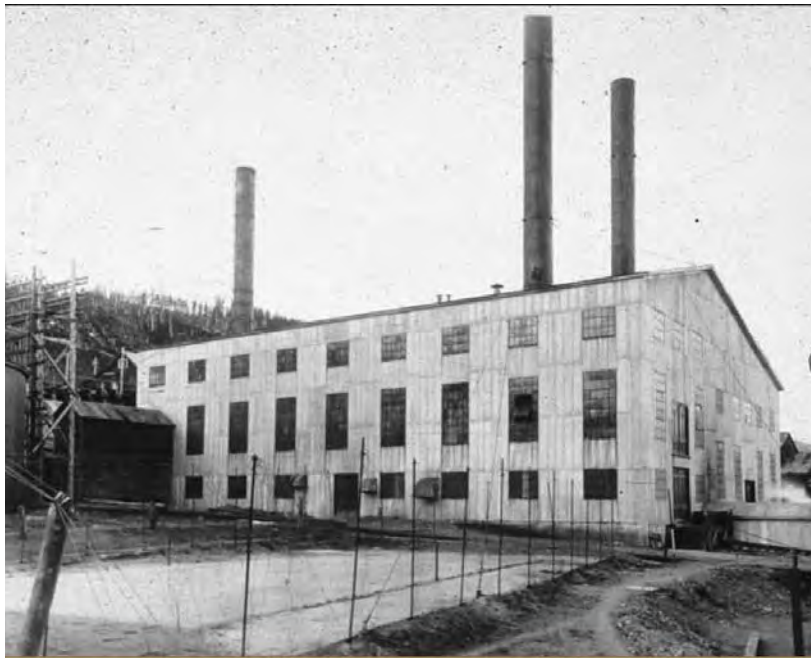

Central Power Plant, ca. 1900
Photo courtesy of Treadwell Historic Preservation and Restoration Society

TREADWELL HISTORIC DISTRICT

CENTRAL POWER PLANT



Remains of Central Power Plant, August 2009
Photo courtesy of Wayne Jensen



Remains of Central Power Plant, August 2009
Photo courtesy of Wayne Jensen

TREADWELL HISTORIC DISTRICT

CENTRAL POWER PLANT

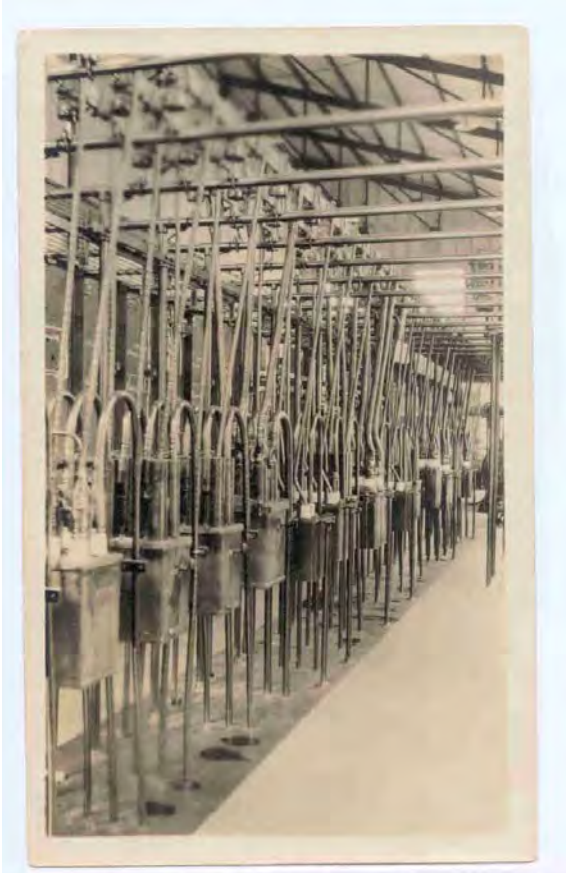

Central Power Plant

Photo courtesy of Juneau Douglas City Museum



Central Power Plant

Photo courtesy of Juneau Douglas City Museum

TREADWELL HISTORIC DISTRICT

TENNIS COURT

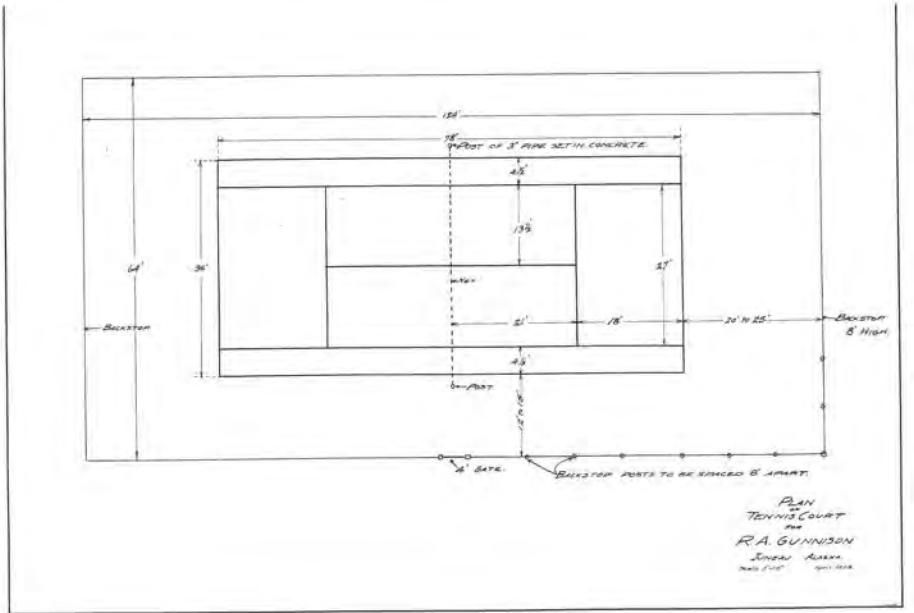

Plan of Tennis Court, April 1914

Drawing courtesy of Alaska State Library Historical Collections

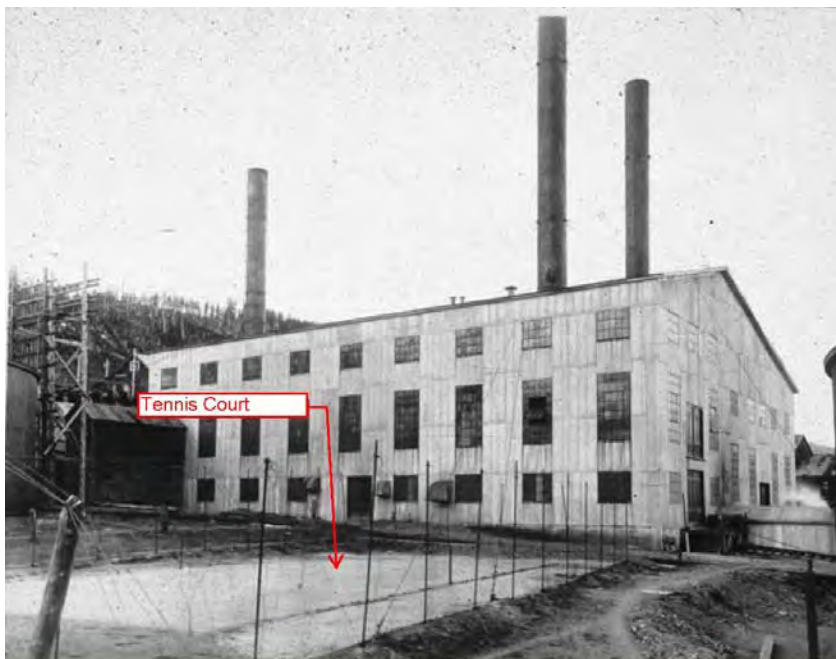

Photo of Tennis Court

Photo courtesy of Treadwell Historic Preservation Society

TREADWELL HISTORIC DISTRICT

TENNIS COURT



Tennis Court with Central Power Plant in background, July 2010
Photo Courtesy of Wayne Jensen

TREADWELL HISTORIC DISTRICT

SUPERINTENDENTS HOUSE



Superintendent's House before bedroom addition.
Photo courtesy of Juneau Douglas City Museum

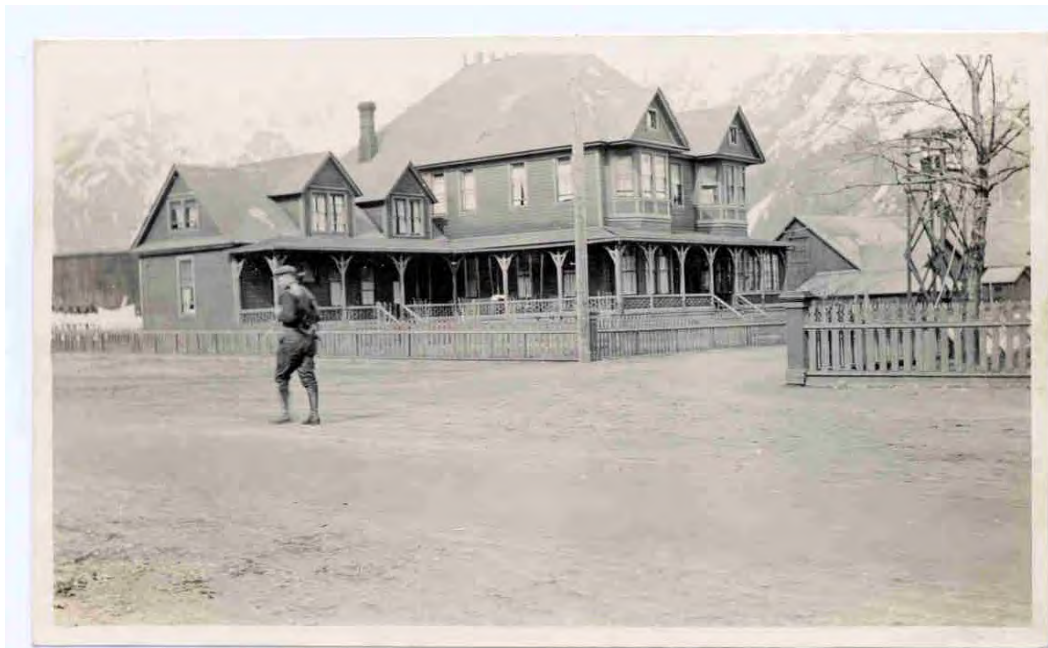

Superintendent's House after second story bedroom addition.
Photo courtesy of Juneau Douglas City Museum

TREADWELL HISTORIC DISTRICT

SUPERINTENDENTS HOUSE

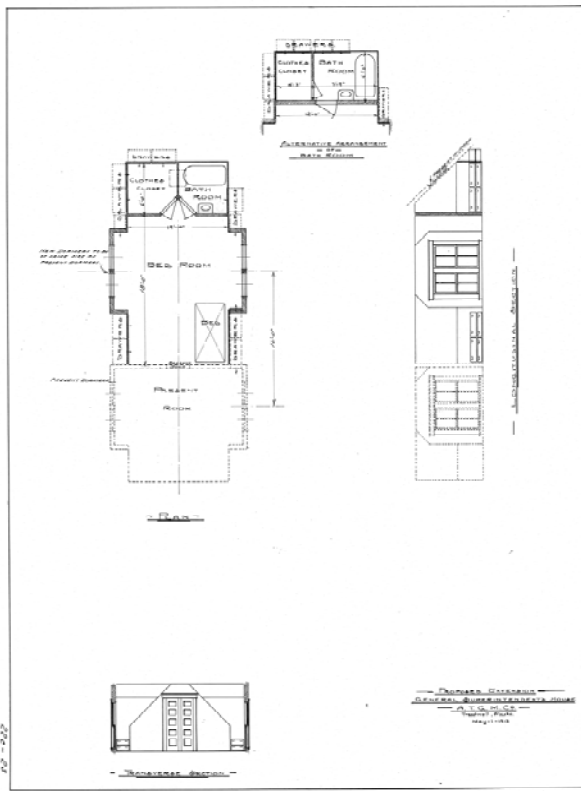

Proposed second floor bedroom addition General Superintendent's House, May 1913
Drawing courtesy of Alaska State Library Historical Collections, AJT Collection

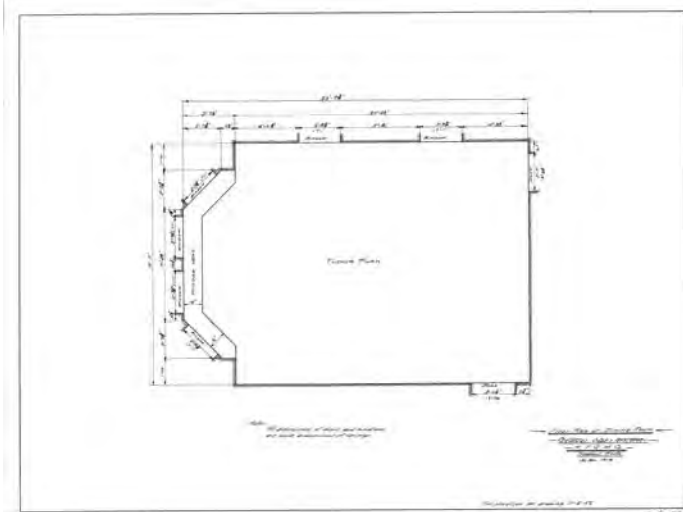

Floor Plan of Dining Room General Superintendent's House December 1914
Drawing Courtesy of Alaska State Library Historical Collections, AJT Collection

TREADWELL HISTORIC DISTRICT

SUPERINTENDENTS HOUSE

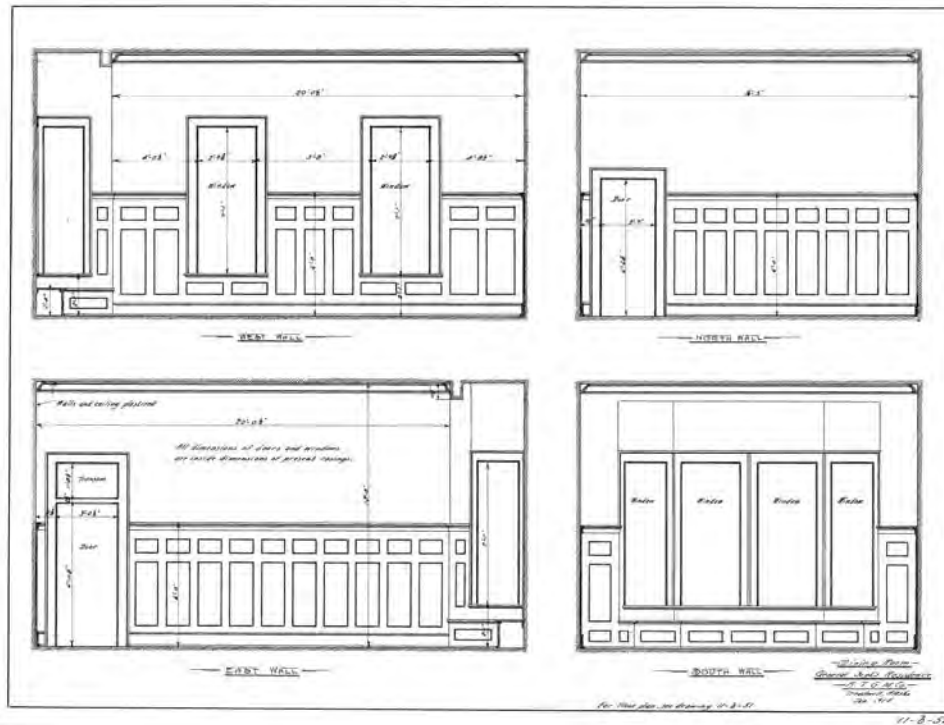

Dining Room Elevations General Superintendent's House, December 1915
Drawing courtesy of Alaska State Library Historical Collections, AJT Collection

TREADWELL HISTORIC DISTRICT

ASSISTANT SUPERINTENDENTS HOUSE



Assistant Superintendent's House
Alaska State Library, Juliane Nick Dexter Photo Collection, ASL-P40-16

Assistant Superintendent's House July 1908
Alaska State Library, Case & Draper Collection, ASL-P39-0864



TREADWELL HISTORIC DISTRICT

TREADWELL PLAZA



Fourth of July in Treadwell Plaza, 1908

Alaska State Library, William R. Norton Collection, W.H. Case, ASL-P226-305



Treadwell Plaza, July 1908

Alaska State Library, Case & Draper Collection, ASL-P39-0864

TREADWELL HISTORIC DISTRICT

TREADWELL PLAZA



Treadwell Plaza July 2010
Photo by Wayne Jensen

TREADWELL HISTORIC DISTRICT

BARN



Alaska State Library - Historical Collections

Barn

Barn, adjacent to Treadwell Plaza July 1908

Alaska State Library, William R. Norton Collection, W.H. Case, ASL-P226-305

TREADWELL HISTORIC DISTRICT

STORE

AHRS#: **CBJ#:** **Parcel#:** **Year Built:**
2-D03-0-102-006-1
Historic Name: Store **Other Name:**
Location: Treadwell **Legal Description:**
Historic Use: Merchandising **Current Use:**

Architectural Style:

General Description: A two story wood building, or collection of buildings that housed the General Store and Butcher Shop. On the south side of the store were two concrete vaults and beyond them was the New Office Building that was constructed in 1914. Only the deteriorating vaults and a few concrete foundations remain.

Architectural Features:

Historical Information: The store stocked basic food stuffs and clothing as well as toys, fancy food and clothes. The adjacent butcher shop had refrigerated meat cases. The prices were reportedly lower than stores in the nearby towns of Juneau and Douglas.

Alterations:

Comments:

Entry Date: 07/08/10

Survey By: Wayne Jensen

TREADWELL HISTORIC DISTRICT

STORE AND BUTCHER SHOP



Alaska State Library - Historical Collections

Treadwell Store, 1908

Alaska State Library, William R. Norton Photographs, Case & Draper, ASL-P226-330



Alaska State Library - Historical Collections

Interior photo of Treadwell Store

Alaska State Library, Case & Draper Collection, ASL-P39-0902

TREADWELL HISTORIC DISTRICT

STORE AND BUTCHER SHOP



Alaska State Library - Historical Collections

Interior of Treadwell Store

Alaska State Library, Paul Sincic Collection, Louis H. Pedersen, ASL-P75-409



Alaska State Library - Historical Collections

Interior of Treadwell Store

Alaska State Library, Paul Sincic Collection, Louis H. Pedersen, ASL-P75-410

TREADWELL HISTORIC DISTRICT

STORE AND BUTCHER SHOP



Alaska State Library - Historical Collections

Interior of Butcher Shop

Alaska State Library, Case & Draper Collection, ASL-P39-0896



Alaska State Library - Historical Collections

Interior of Treadwell Store

Alaska State Library, Case & Draper Collection, ASL-P39-1142

TREADWELL HISTORIC DISTRICT

STORE AND BUTCHER SHOP



Concrete Foundations in foreground possibly from butcher shop at north side of store. New Office Building in the background.

Photo courtesy of Wayne Jensen

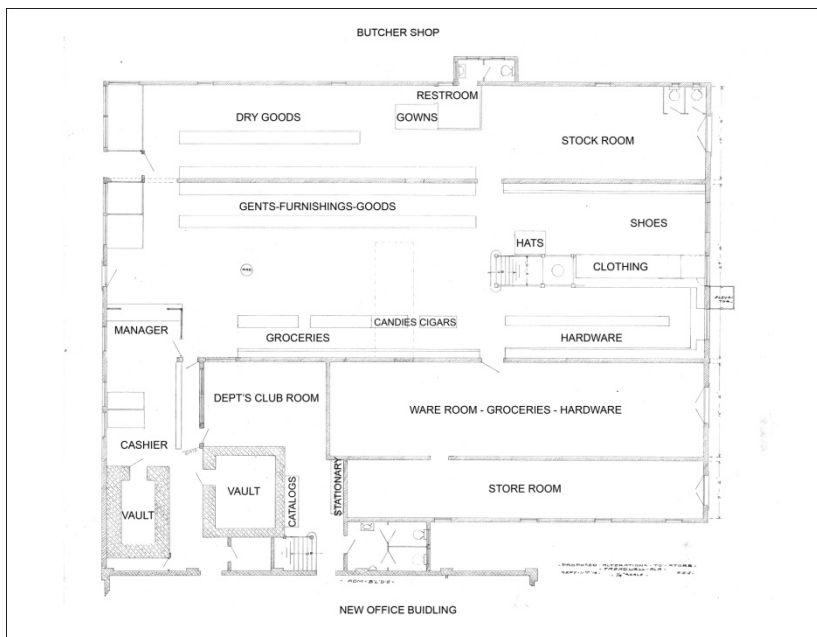

Drawing of proposed alterations to Store circa 1914 courtesy of Alaska State Library Historical Collections, text added by Jensen Yorba Lott.

TREADWELL HISTORIC DISTRICT

NEW OFFICE BUILDING



Alaska State Library - Historical Collections

New Office Building

Alaska State Library, Paul Sincic Collection, Louis H. Pedersen, ASL-P75-411



Treadwell Office Building November 2009;
Photo courtesy of Wayne Jensen

TREADWELL HISTORIC DISTRICT

NEW OFFICE BUILDING



Alaska State Library - Historical Collections

Treadwell Offices

Alaska State Library, Paul Sincic Collection, Louis H. Pedersen, ASL-P75-416



Office building October 2009,
Photo courtesy of Wayne Jensen

TREADWELL HISTORIC DISTRICT

NEW OFFICE BUILDING

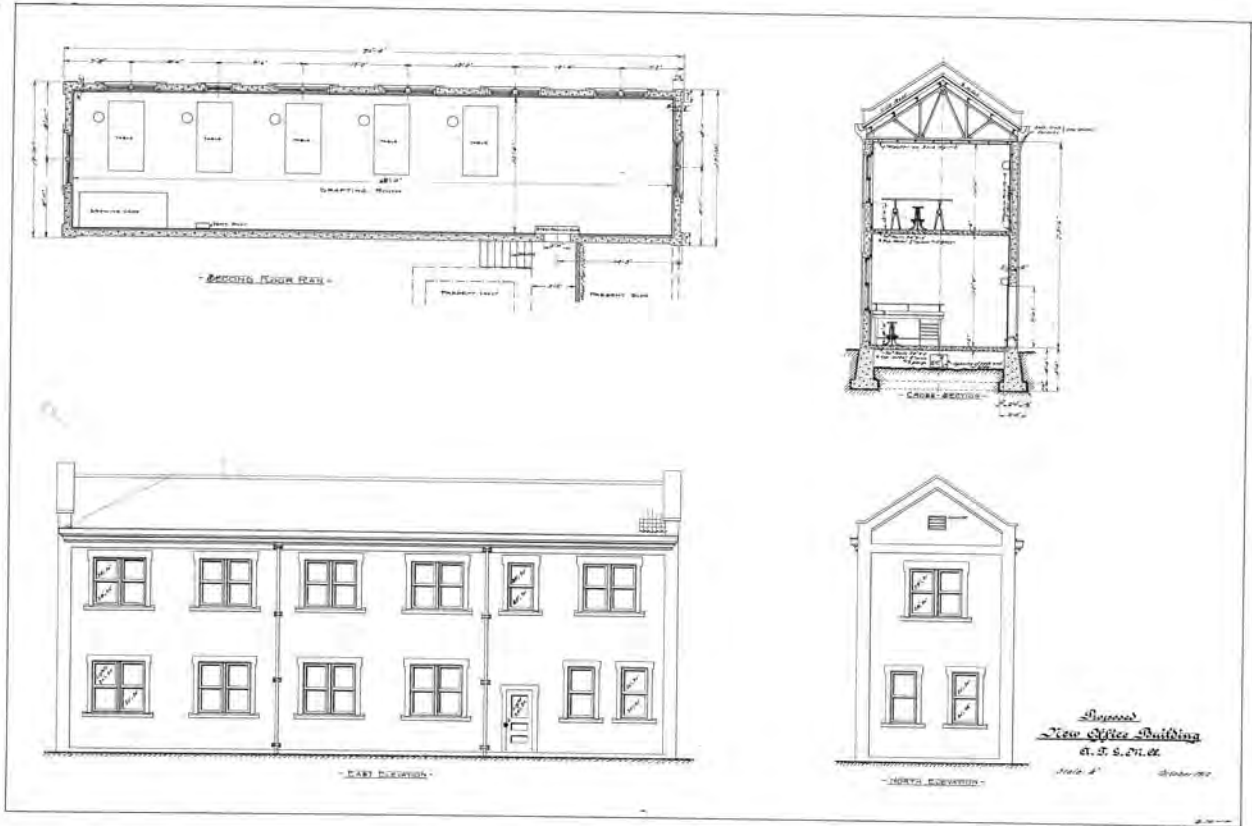

Design as originally proposed with Gable Ends and Tile Roof, October 1912
Drawing courtesy of Alaska State Library Historical Collections

TREADWELL HISTORIC DISTRICT

NEW OFFICE BUILDING

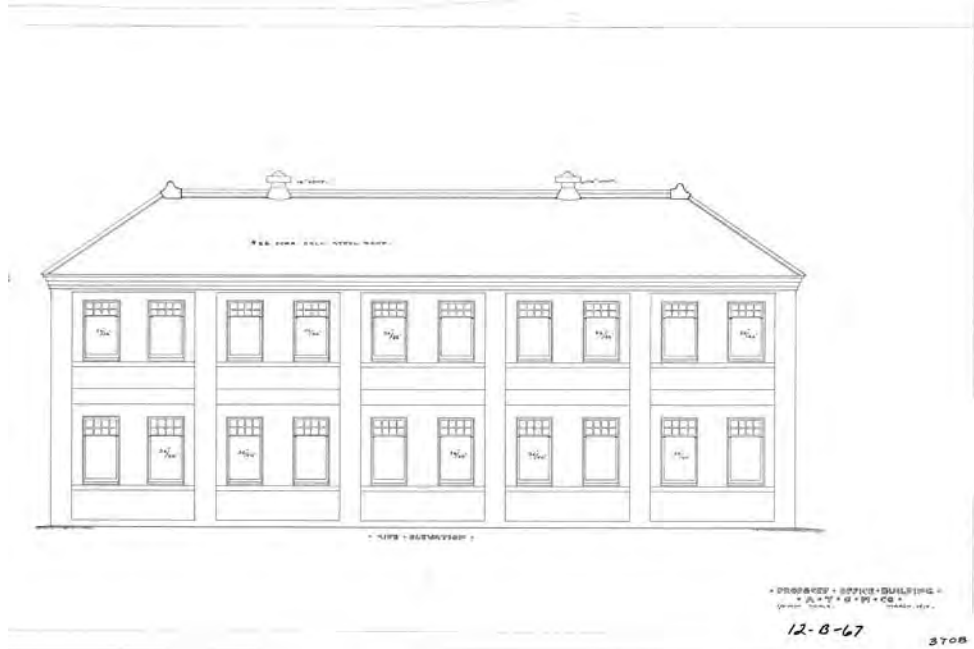

Side Elevation, March 1914

Drawing courtesy of Alaska State Library Historical Collections



North Elevation, March 1914

Drawing courtesy of Alaska State Library Historical Collections

**Building as constructed with
hip metal roof.**

TREADWELL HISTORIC DISTRICT

NEW OFFICE BUILDING

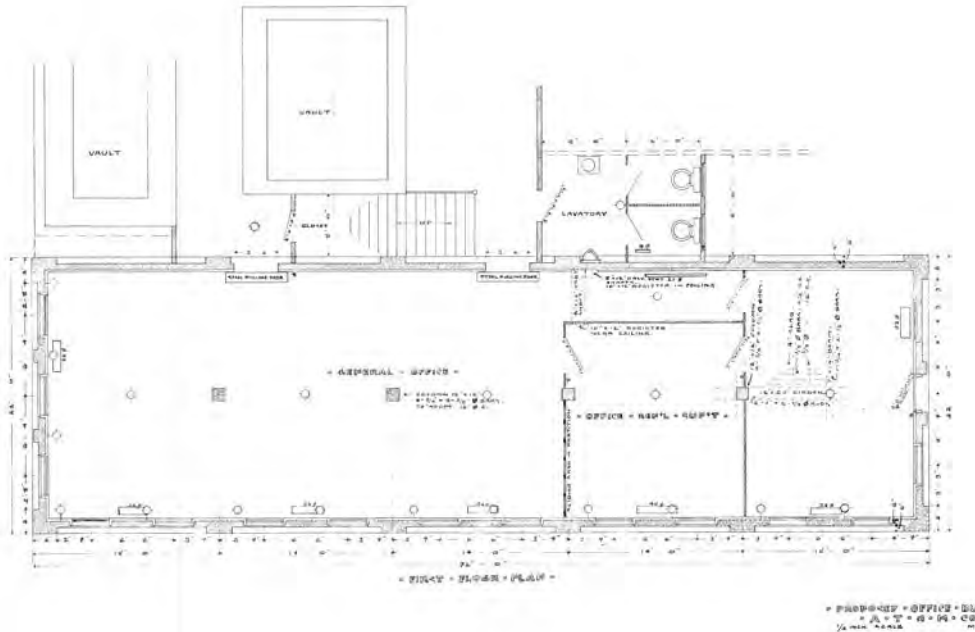

First Floor Plan, March 1914
Drawing courtesy of Alaska State Library Historical Collections

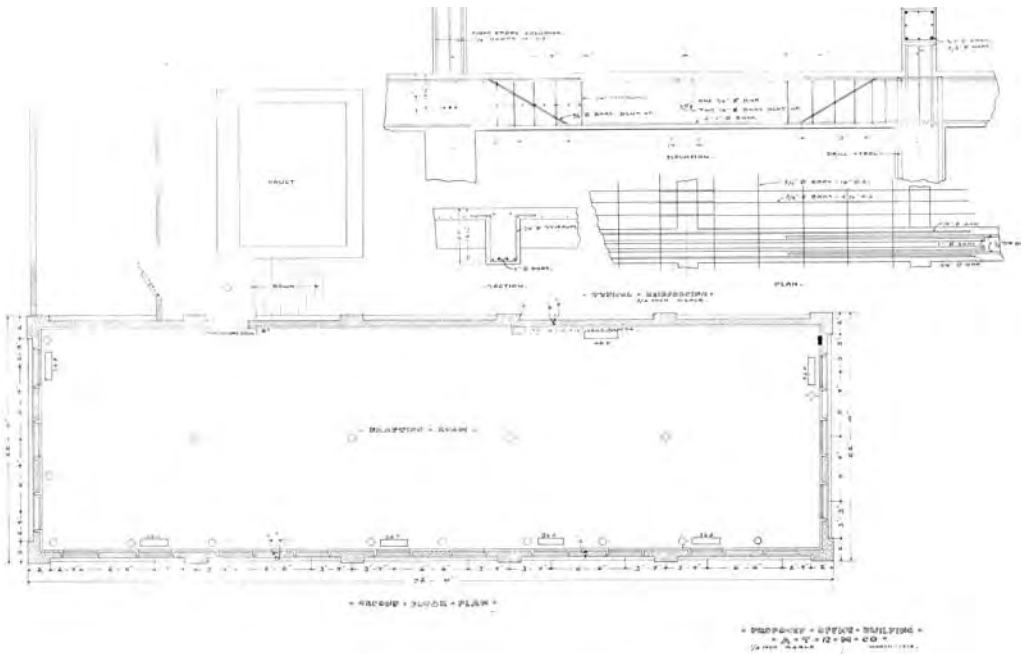

Second Floor Plan, March 1914
Drawing courtesy of Alaska State Library Historical Collections

TREADWELL HISTORIC DISTRICT

ASSAY OFFICE

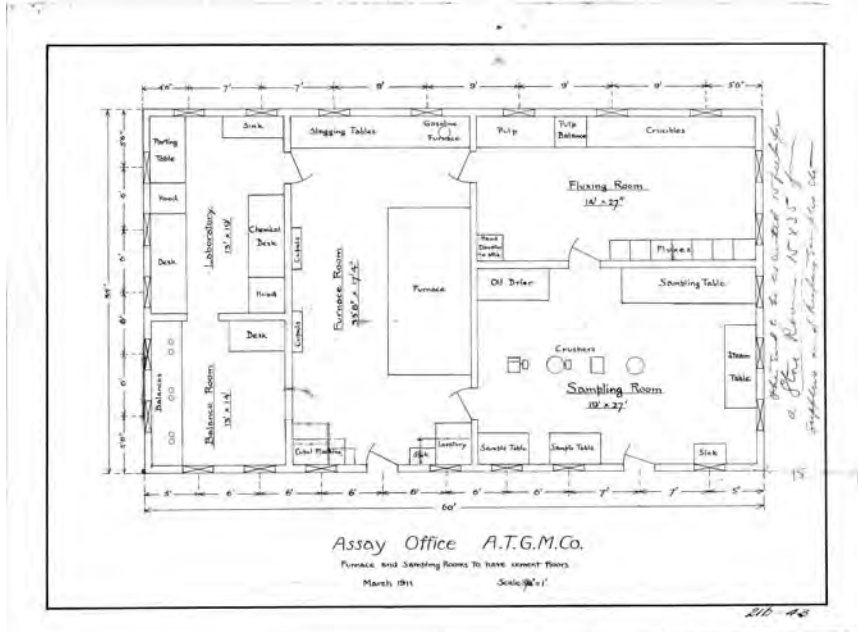

Assay Office Plan 1911, courtesy of Alaska State Library Historical Collections-AJT Collection

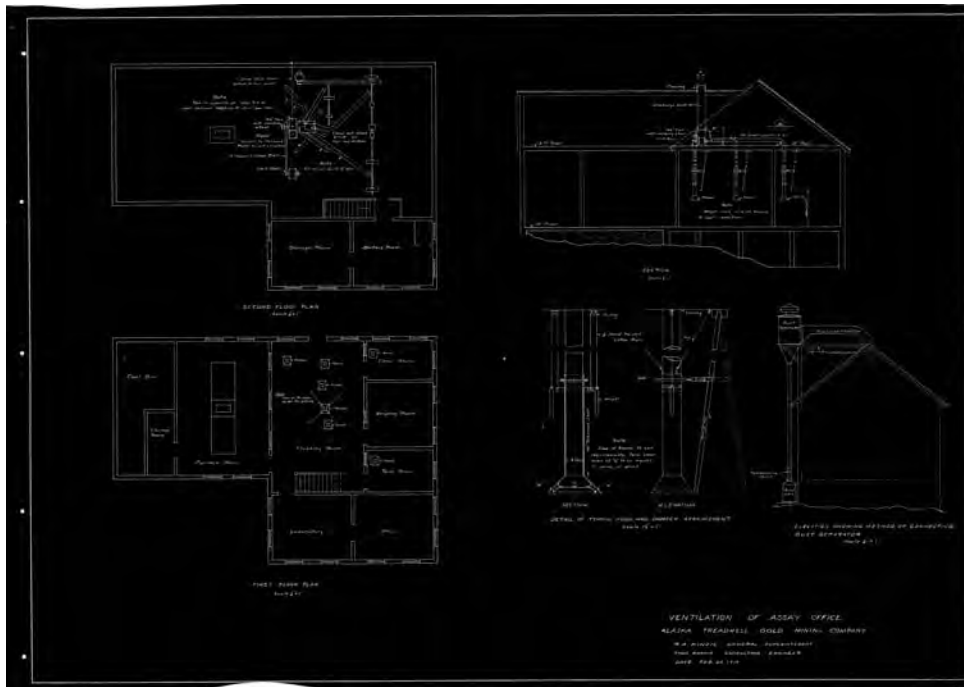

Assay Office Plan 1911, courtesy of Alaska State Library Historical Collections, AJT Collection

TREADWELL HISTORIC DISTRICT

ASSAY OFFICE

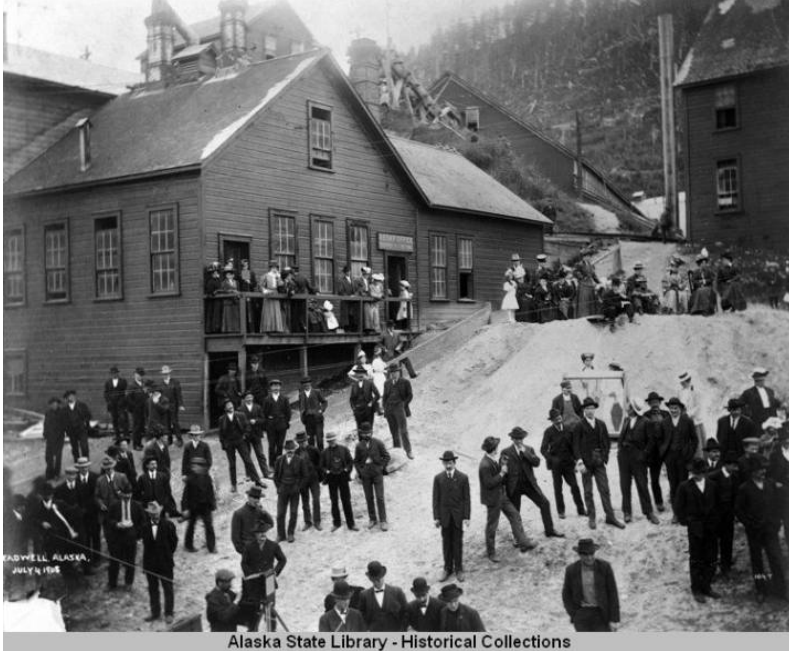

Alaska State Library - Historical Collections

Assay Office 1908,
Alaska State Library, Juliane Nick Dexter Collection, W.H. Case, ASL-P40-32



Remains of Assay Office May 2010,
photo courtesy of Wayne Jensen

TREADWELL HISTORIC DISTRICT

SCHOOL HOUSE

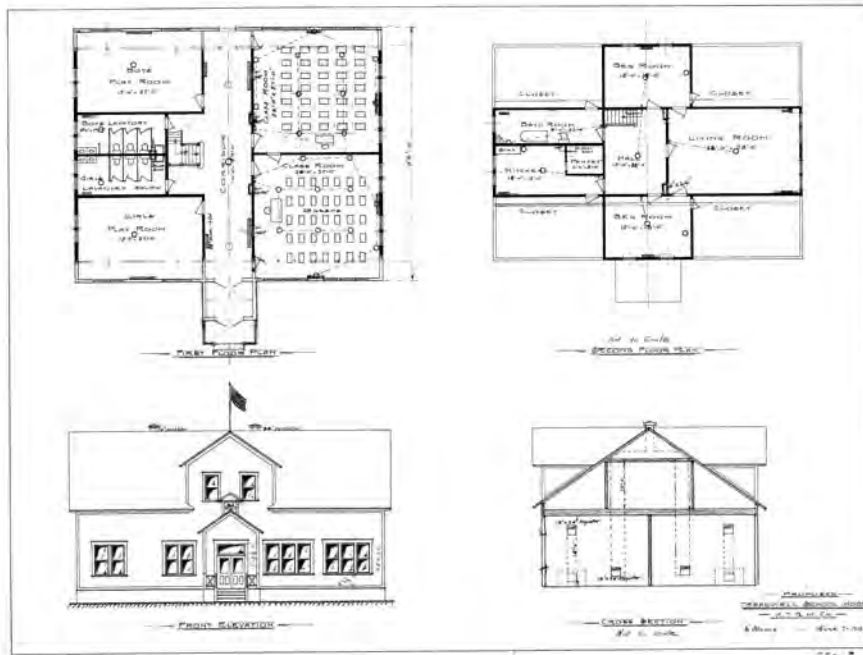

Proposed Treadwell School House, June 1913

Drawing courtesy of Alaska State Library Historical Collections, AJT Collection



Students in front of Treadwell School

Photo courtesy of Juneau Douglas City Museum

TREADWELL HISTORIC DISTRICT

WHARF & WAREHOUSES



Alaska State Library - Historical Collections

Treadwell Wharf

Alaska State Library, William R. Norton Collection, Case & Draper, ASL-P226-309



Steamship at Treadwell Wharf

Photo courtesy of Juneau Douglas City Museum

TREADWELL HISTORIC DISTRICT

WHARF & WAREHOUSES

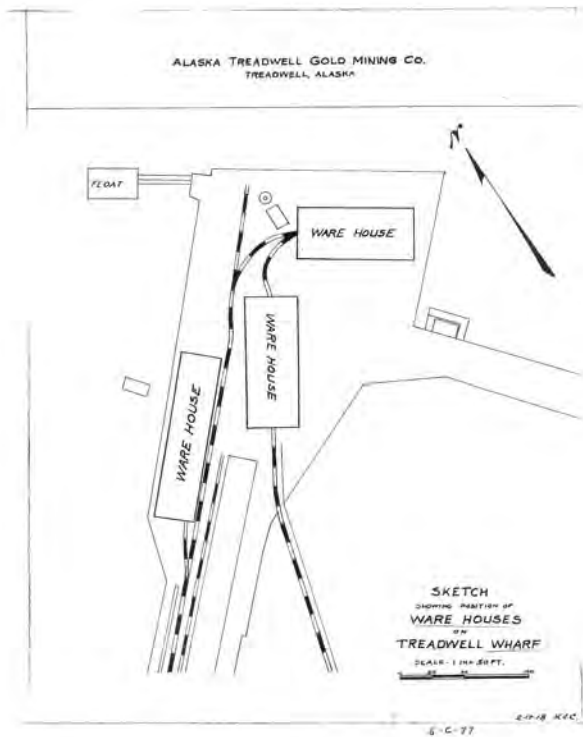

Sketch showing position of warehouses on Treadwell Wharf, 1918
Drawing courtesy of Alaska State Library Historical Collections, AJT Collection



Remains of Treadwell Wharf
April 2010

Photo courtesy of Wayne Jensen

TREADWELL HISTORIC DISTRICT

WHARF & WAREHOUSES

Historic Image:

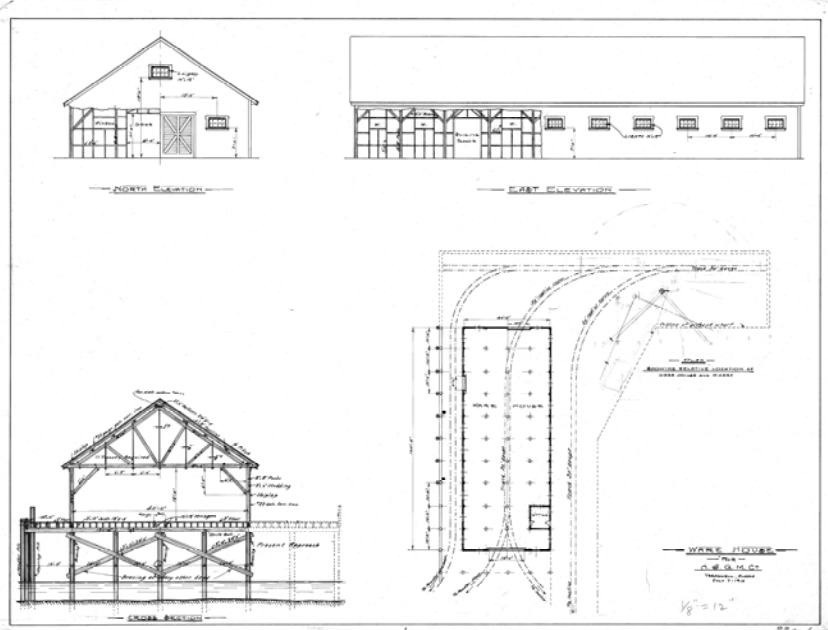

Warehouse plan, 1913

Drawing courtesy of Alaska State Library Historical Collections, AJT Collection

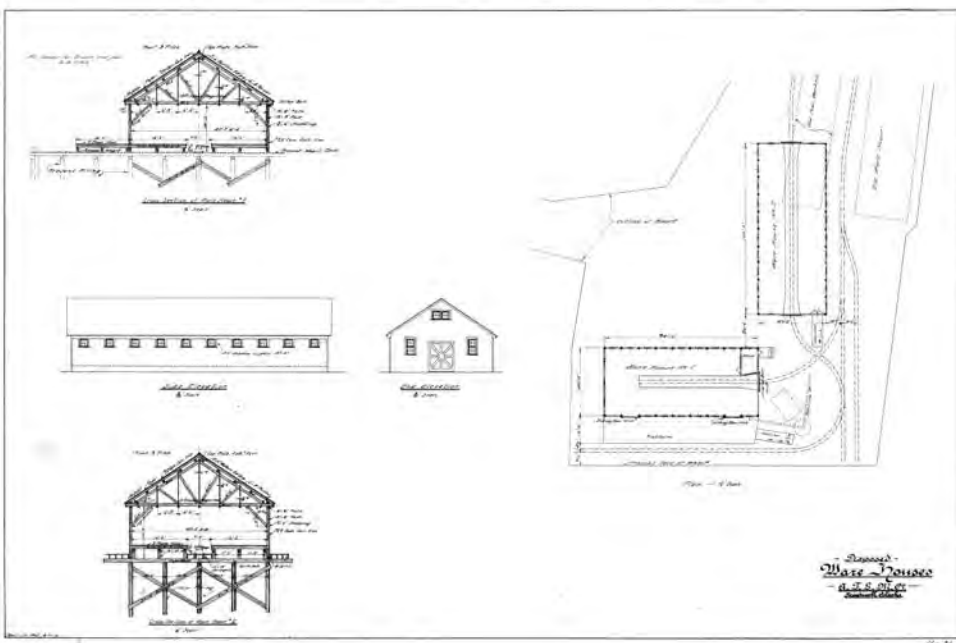

Proposed Warehouses at Treadwell, 1914

Drawing courtesy of Alaska State Library Historical Collections, AJT Collection

TREADWELL HISTORIC DISTRICT

WHARF & WAREHOUSES

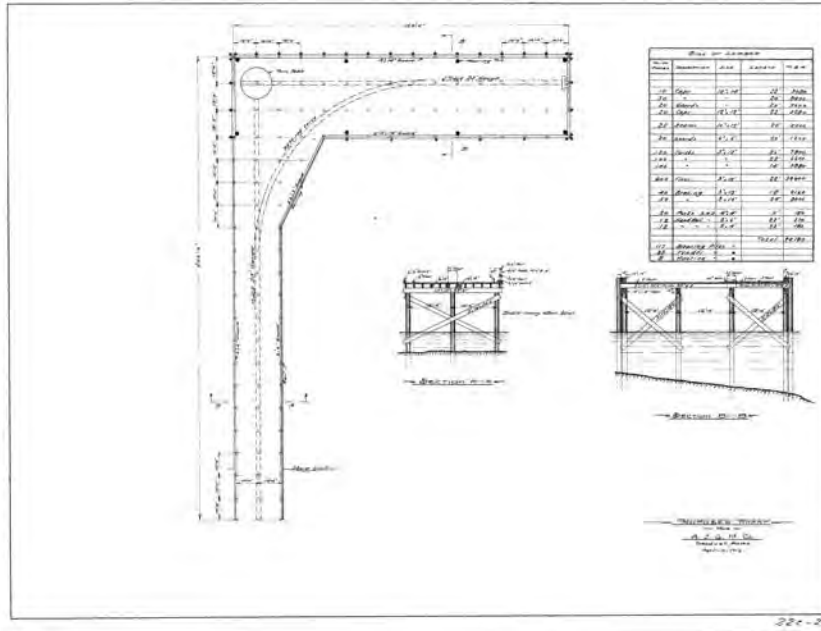

**Proposed Wharf for AJGM Co, Treadwell, Alaska
April 1913**
Drawing courtesy of
*Alaska State Library
Historical Collections, AJT
Collection*

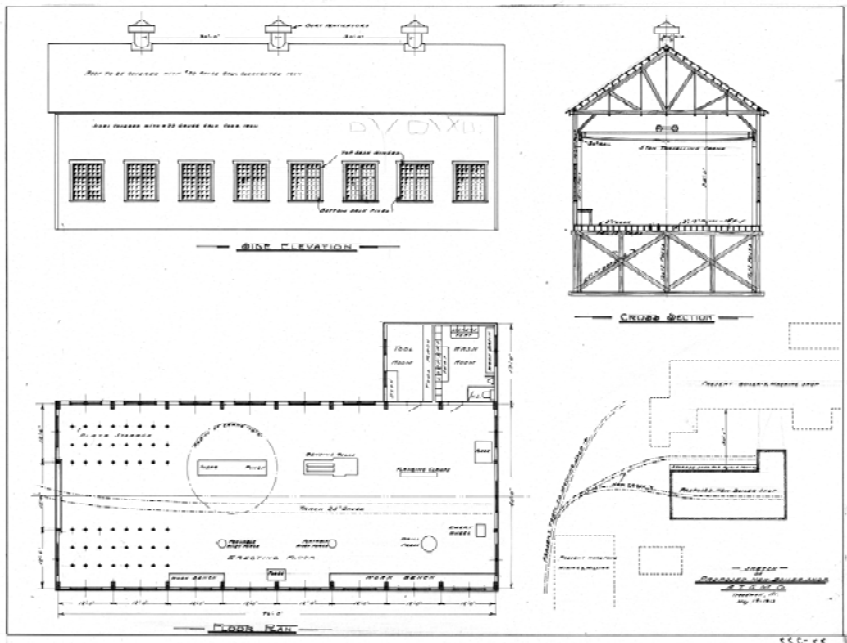

Proposed new Boiler Shop, 1913
Drawing courtesy of
*Alaska State Library
Historical Collections, AJT
Collection*

TREADWELL HISTORIC DISTRICT

PUMP HOUSE

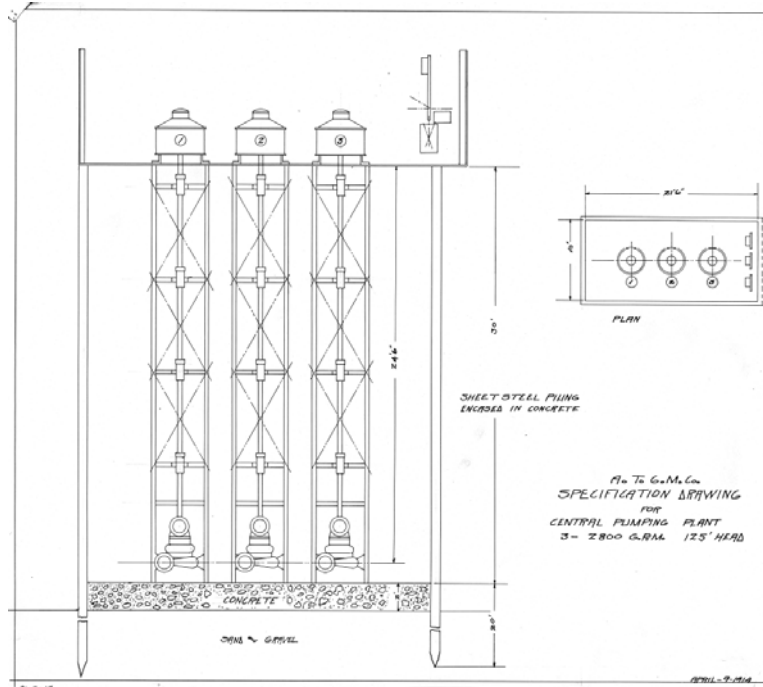

Specification drawing for Central Pumping Plant, April 1914
Drawing courtesy of Alaska State Library Historical Collections



Central Pumping House, June 2010
Photo courtesy of Wayne Jensen

TREADWELL HISTORIC DISTRICT

TREADWELL BOARDING HOUSE



Alaska State Library - Historical Collections

Treadwell Boarding House Main Dining Room July 1908
Alaska State Library, Case & Draper Collection, W.H. Case, ASL-P39-0994



Alaska State Library - Historical Collections

Treadwell Boarding House Main Dining Room
Alaska State Library, William R. Norton Collection, Case & Draper, ASL-P226-325

TREADWELL HISTORIC DISTRICT

TREADWELL BOARDING HOUSE



Treadwell Boarding House Kitchen East Side
Alaska State Library, William R. Norton, Case & Draper, ASL-P226-329

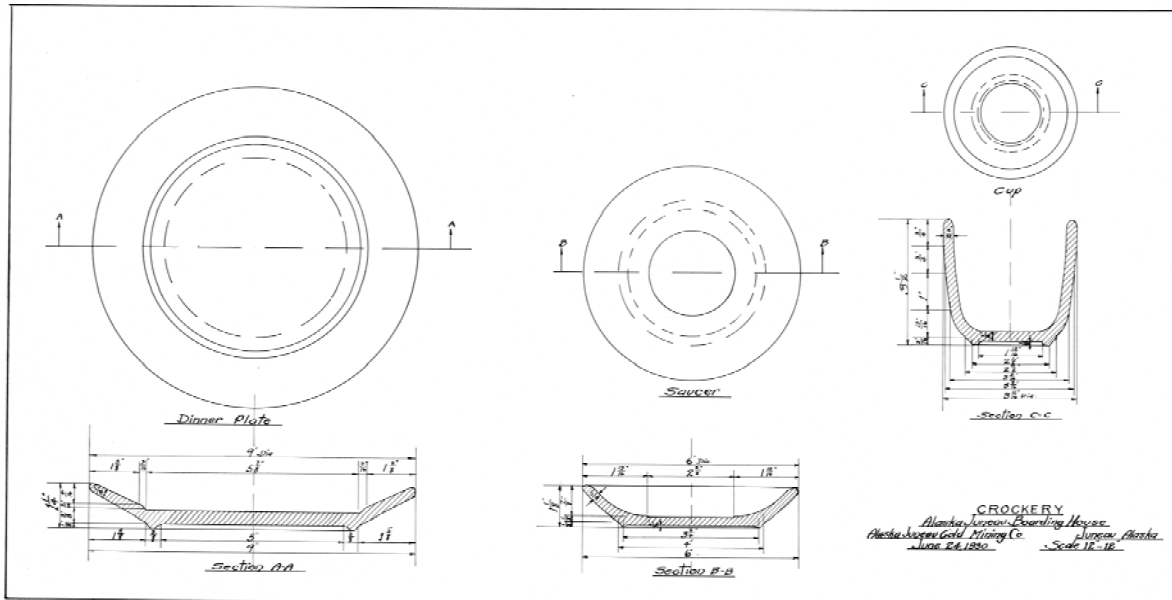

Crockery for Alaska Juneau Boarding House, June 1930
Drawing courtesy of Alaska State Library Historical Collections, AJT Collection

TREADWELL HISTORIC DISTRICT

DORMITORIES

AHRS#: **CBJ#:** **Parcel#:** **Year Built:**
2-D03-0-102-006-1
Historic Name: Bunkhouses **Other Name:** Dormitories
Location: Treadwell **Legal Description:**
Historic Use: Housing **Current Use:** N/A

Architectural Style:

General Description: Four wood frame dormitories were located along the beach between the Boarding House and the Treadwell Club housing single miners. Some concrete foundations and miscellaneous plumbing fixtures remain.

Architectural Features:

Historical Information: The dormitories were 2 and 3 story buildings with up to 54 bedrooms each shared by 2 miners.

Alterations:

Comments:

Entry Date: 07/13/10

Survey By: Wayne Jensen

TREADWELL HISTORIC DISTRICT

DORMITORIES

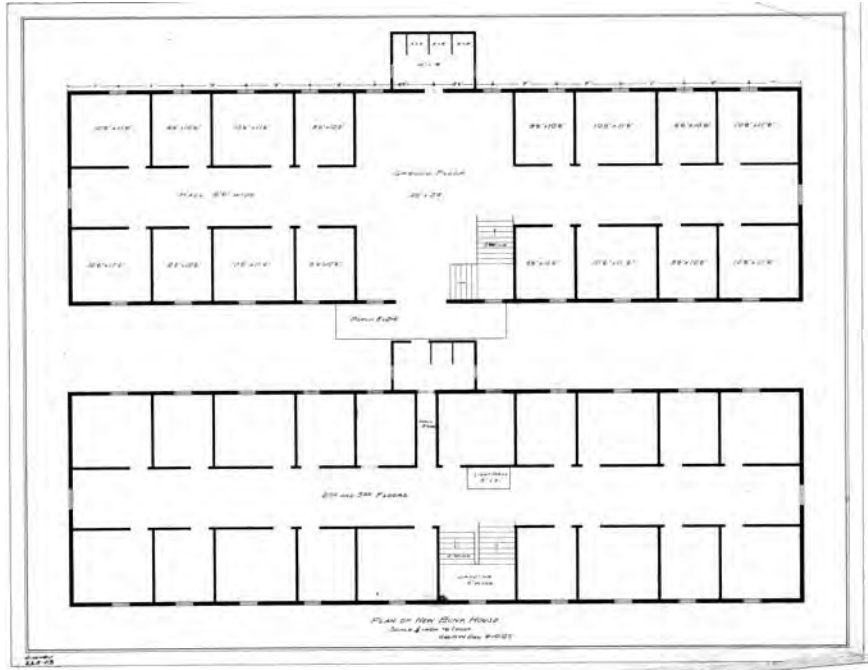

Plan of typical bunkhouse, September 1907

Drawing courtesy of Alaska State Library Historical Collections, AJT Collection



Elevation of typical bunkhouse, September 1907

Drawing courtesy of Alaska State Library Historical Collections, AJT Collection

TREADWELL HISTORIC DISTRICT

DORMITORIES



Alaska State Library - Historical Collections

Working men's quarters, Treadwell, Alaska, 1908

Alaska State Library, Paul Sincic Collection, Louis H. Pedersen, ASL-P75-423



Alaska State Library - Historical Collections

Miners pose in front of bunkhouses, 1908

Alaska State Library, William R. Norton Collection, W.H. Case, ASL-P226-339

TREADWELL HISTORIC DISTRICT

DORMITORIES



**Foundations & Plumbing Fixtures from
Bunkhouse April 2010**
Photo Courtesy of Wayne Jensen

**Foundations from dormitory near
cave-in, May 2010**
Photo courtesy of Wayne Jensen



TREADWELL HISTORIC DISTRICT

TREADWELL CLUB

AHRS#: **CBJ#:** **Parcel#:** **Year Built:** 1904
2-DO3-0-102-006-1
Historic Name: Treadwell Club **Other Name:**
Location: Treadwell **Legal Description:**
Historic Use: Recreation **Current Use:** N/A
Architectural Style:

General Description: A 56 ½' by 202 ½' heavy timber framed building with a hip roof with timber roof trusses and purlins, 2 x 6 wood rafters, wood wall and roof sheathing, tar and gravel roofing and wood siding. The foundation was wood piling and the floor was framed with timber beams, 2 x 12 floor joists and oak flooring. The ceiling was 16' high with a balcony suspended from the roof trusses. All that remains are some of the wood pilings on the beach near the cave in site.

Architectural Features:

Historical Information: Originally organized by employees as a Y.M.C.A. in 1903, the building was located about 40 feet south of the boarding house. It was equipped with a reading room, library, gymnasium, bowling alley, bathrooms, auditorium and stage. Members were required to pay \$1.00 per month for dues. This building was a center of interest among the men, especially the single ones who had no family to go home to after work. The original structure was destroyed by fire in 1904.

Within a year a new club was built about 100 feet south of the old location and became known as the Treadwell Club. The construction cost for the new building was approximately \$20,000. The new club boasted a billiard and pool room, reading and correspondence room, library, dark room, Turkish bath, regulation double Brunswick bowling alley, barber shop, cigar stand, a 500 person auditorium and even a motion picture machine. There was even a Treadwell Club Band consisting of 25 experienced musicians who gave a free concert once a month. Friday of each week the building was given over to the women.

Alterations:

Comments:

Entry Date: 07/02/10

Survey By: Wayne Jensen

TREADWELL HISTORIC DISTRICT

TREADWELL CLUB



Alaska State Library - Historical Collections

Treadwell Club

Alaska State Library, Case & Draper Collection, Case & Draper, ASL-P39-0888



Pilings are all that remain of the Treadwell Club, June 2010

Photo courtesy of Wayne Jensen

TREADWELL HISTORIC DISTRICT

TREADWELL CLUB

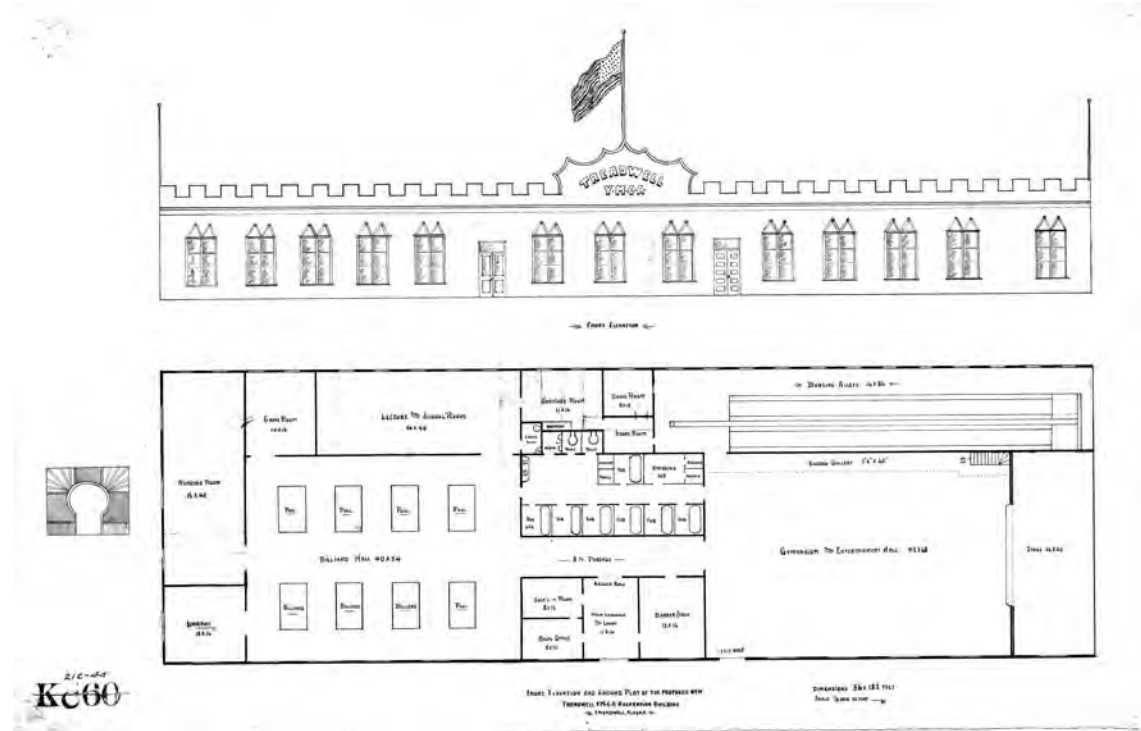

Y.M.C.A. Building

Drawing courtesy of Alaska State Library Historical Collections, AJT Collection

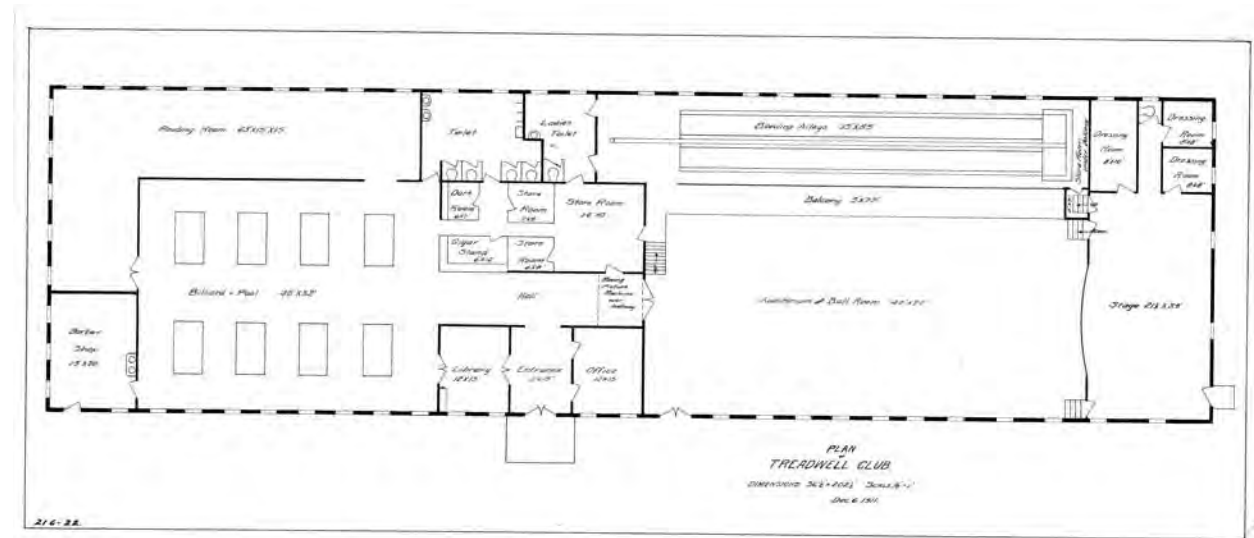

Floor Plan of Treadwell Club as constructed

Drawing courtesy of Alaska State Library Historical Collections, AJT Collection

TREADWELL HISTORIC DISTRICT

TREADWELL CLUB

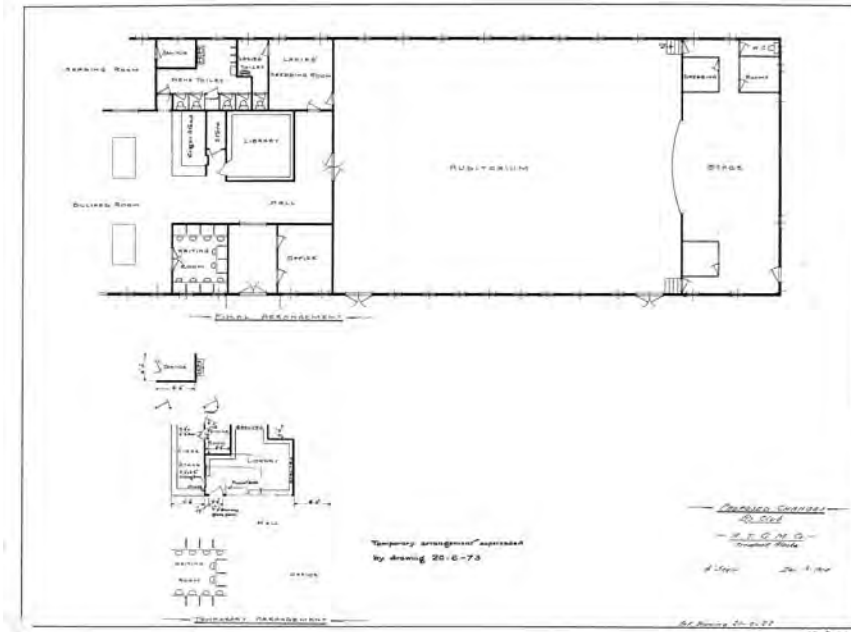

Proposed changes to Treadwell Club, December 1914
Drawing courtesy of Alaska State Library Historical Collection, AJT Collection



Treadwell Club Bowling Alley
Alaska State Library, William R. Norton Collection, W.H. Case, ASL-P226-332

TREADWELL HISTORIC DISTRICT

TREADWELL CLUB



Alaska State Library - Historical Collections

Auditorium

Alaska State Library, William R. Norton Collection, W.H. Case, ASL-P226-331



Alaska State Library - Historical Collections

Treadwell Club, 1907

Alaska State Library, Case & Draper Collection, W.H. Case, ASL-P39-075

TREADWELL HISTORIC DISTRICT

NATATORIUM

AHRS#: **CBJ#:** **Parcel#:** **Year Built:**
2-D03-0-102-006-1
Historic Name: Natatorium **Other Name:** Swimming Tank
Location: Treadwell **Legal Description:**
Historic Use: Recreation **Current Use:** N/A

Architectural Style:

General Description: Approximately 70' x 30' wood framed building on pilings adjacent the Treadwell Club. Some sources place the size at 40' x 75'. The Natatorium was completely tiled and steam heated. It has been reported that there was a gymnasium in the building also. The building was constructed on new land created by the mine tailings.

Architectural Features:

Historical Information: The natatorium like many Treadwell facilities boasted top of the line amenities not commonly found elsewhere. The "tank" as it was called offered a scale to weigh oneself and provided towels with the company's logo embroidered in red. The tank hosted water carnivals and races and specific days were reserved for women and children. Signs of structural instability began appearing in 1916 caused by the caving of the stopes and adits of the 700' mine. On the Friday before the cave-in the pool was in use by the ladies when at once the water left the pool "in one big gulp". The building was evacuated at which time large fissures were discovered all around the building and in the street. The building was roped off to access. The next morning people went to see what there was left to see only to discover that nothing was left save for the roped off space. An extreme high tide the night before flooded the mine creating a massive cave-in which swallowed the natatorium whole along with the old fire hall and another small outbuilding.

Alterations:

Comments:

Entry Date: 07/13/10

Survey By: Wayne Jensen

TREADWELL HISTORIC DISTRICT

NATATORIUM

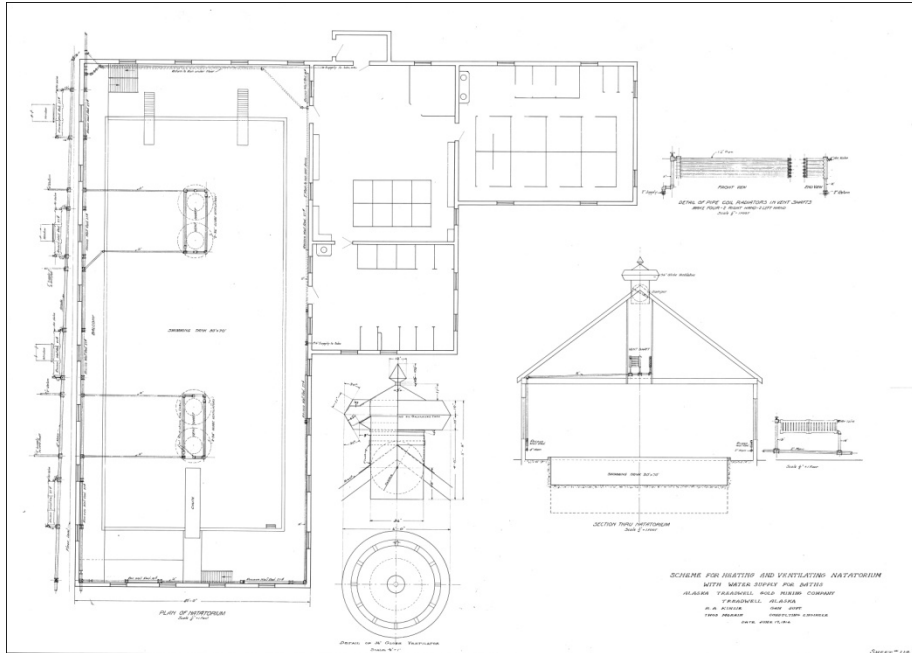

Scheme for Heating and Ventilating Natatorium, June 1914
Drawing courtesy of Alaska State Library Historical Collections, AJT Collection

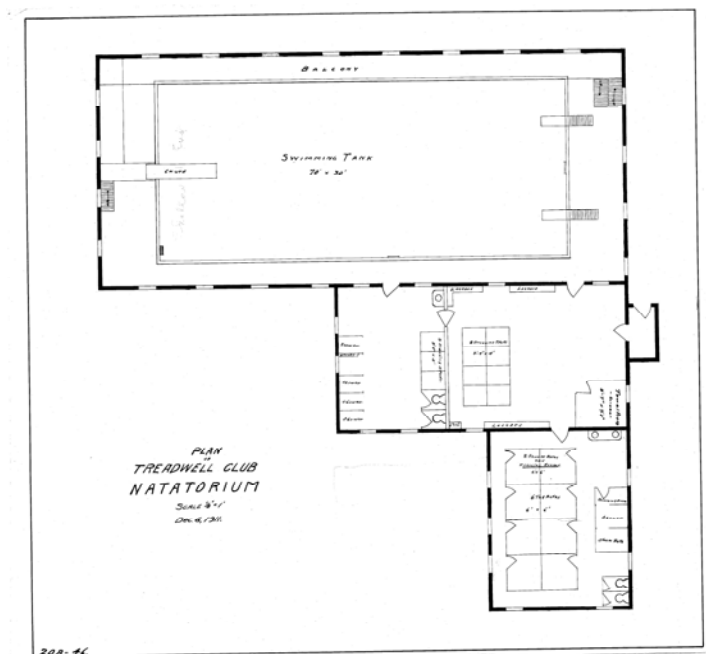

Plan for Treadwell Club Natatorium, December 1911
Drawing courtesy of Alaska State Library Historical Collections

TREADWELL HISTORIC DISTRICT

NATATORIUM



Alaska State Library - Historical Collections

Natatorium, Treadwell Alaska, circa 1900

Alaska State Library, Winter & Pond Collection, ASL-P117-118



Treadwell Swimming Tank during time of cave in
Photo courtesy of Juneau Douglas City Museum

TREADWELL HISTORIC DISTRICT

COTTAGES

AHRS#: **CBJ#:** **Parcel#:** **Year Built:** est.
2-D03-0-102-006-1 1900-1910
Historic Name: Cottages **Other Name:** Campbell Hill, Treadwell Heights

Location: Treadwell **Legal Description:**

Historic Use: Housing **Current Use:** N/A

Architectural Style:

General Description: Over 100 cottages were provided for mine foremen and managers as well as married employees. The cottages were located on the Treadwell, 700' and Mexican mine sites. Those in the Treadwell areas were in two groups "Campbell Hill" northwest of the 240 Mill and above the 300 Mill and "Treadwell Heights" east of the 240 Mill and above the dormitories.

Architectural Features: All cottages were painted red with green trim and featured steam heat provided by the Central Power Plant as well as electric lights. Most had bathrooms although some did not. Most were two story, a few were one and one half stories.

Historical Information: Constructed at the turn of the century the cottages housed mine foremen, managers and married employees. The construction cost for these dwellings is estimated at between \$1500 and \$1750 dependent on size. Rent for the cottages ranged from \$10-\$15 per month, also dependent on size. However, the \$10 per month cottages had outhouses rather than indoor toilets and bathrooms.

Alterations:

Comments:

Entry Date: 7/2/2010

Survey By: Wayne Jensen

TREADWELL HISTORIC DISTRICT

Historical Photo:



Alaska State Library, Juliane Nick Dexter Collection, W.H. Case, ASL-P40-10

Current Photo:



Bathtub in Campbell Hill Area, Photo Courtesy of Wayne Jensen

TREADWELL HISTORIC DISTRICT

CENTRAL HOISTING PLANT



Central Crushing Plant, May 2010
Photo courtesy of Wayne Jensen



Pulley from Central Hoist, April 2010
Photo courtesy of Wayne Jensen

TREADWELL HISTORIC DISTRICT

CENTRAL HOISTING PLANT



Foundry mark on pulley indicating it was cast at the Treadwell Foundry in 1908
Photo: May 2010 courtesy of Wayne Jensen

TREADWELL HISTORIC DISTRICT

CENTRAL HOISTING PLANT

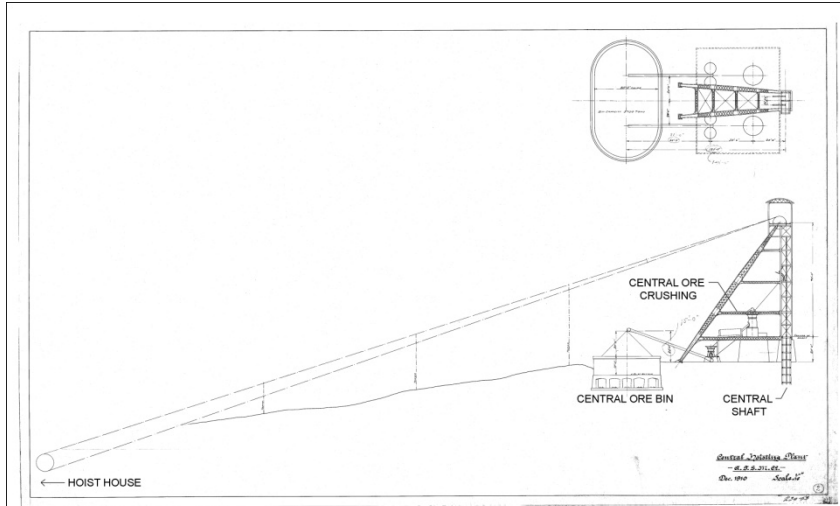

Central Hoisting Plant, December 1910
Drawing Courtesy of Alaska State Library Historical Collections

Central Hoisting Plant and Boiler Room, March 1914
Drawing courtesy of Alaska State Library Historical Collections

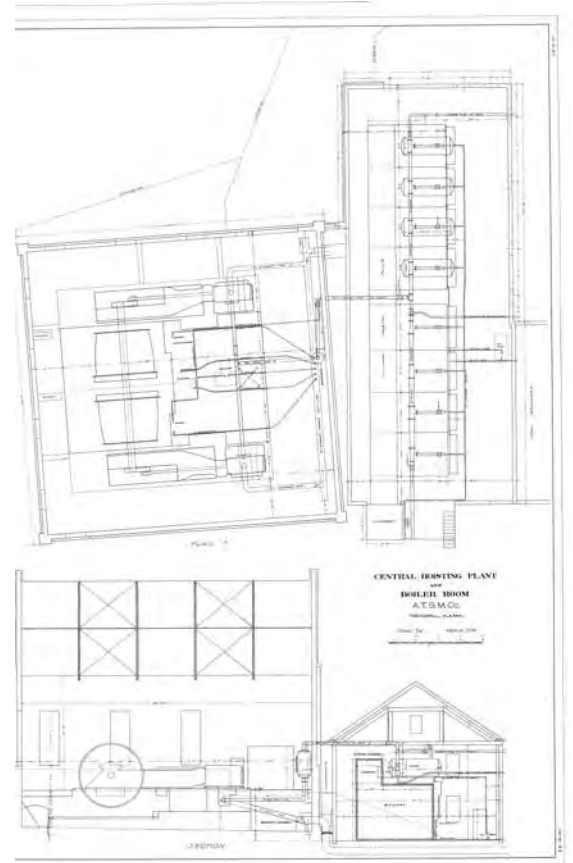

TREADWELL HISTORIC DISTRICT

CENTRAL HOISTING PLANT

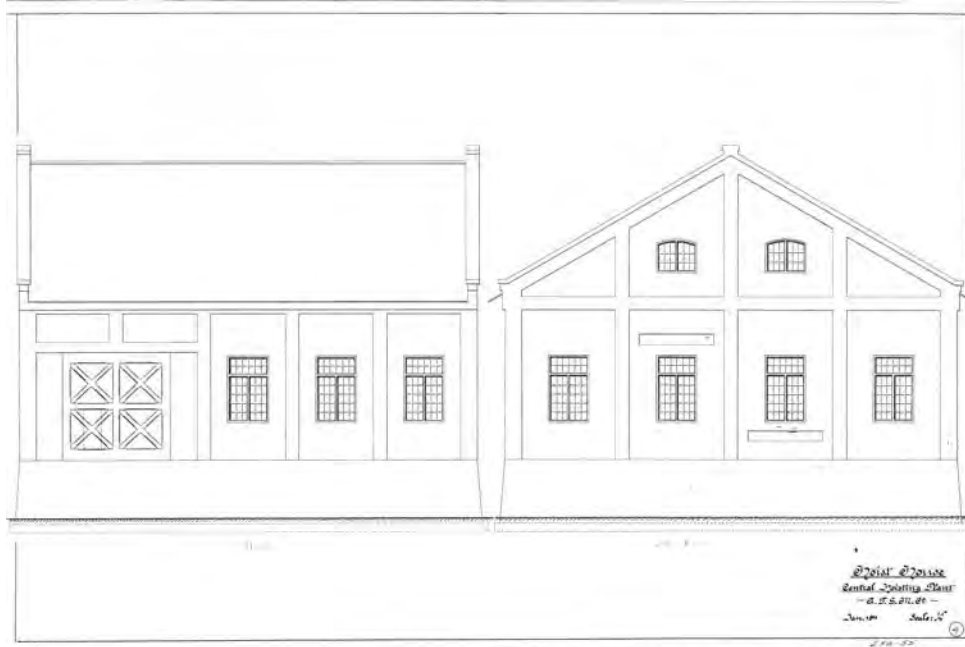

Hoist House, Central Hoisting Plant, December 1911

Drawing courtesy of Alaska State Library Historical Collections, AJT Collection

TREADWELL HISTORIC DISTRICT

CENTRAL HOISTING PLANT



Hoist House, May 2010
Photo courtesy of Wayne Jensen

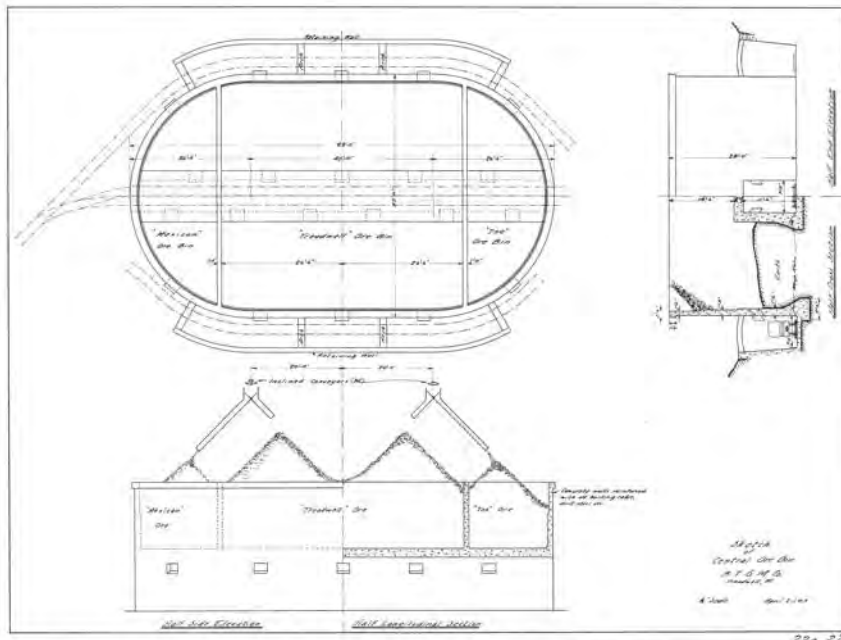

Central Ore Bin April 1913
Drawing courtesy of Alaska State Library Historical Collections, AJT Collection

TREADWELL HISTORIC DISTRICT

CENTRAL HOISTING PLANT

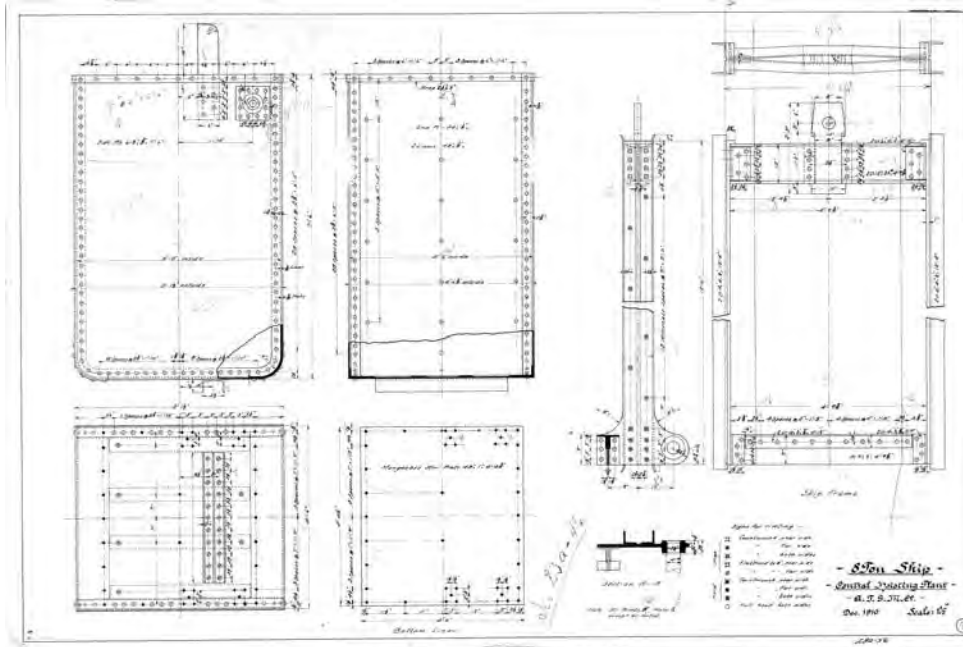

8 Ton Skip, Central Hoisting Plant December 1910

Drawing courtesy of Alaska State Library Historical Collections, AJT Collection



Skip at Central Hoist Shaft used to lift ore from Mine to Central Crushing Plant

Photo April 2010 courtesy of Wayne Jensen

TREADWELL HISTORIC DISTRICT

240 STAMP MILL

Historical Image:

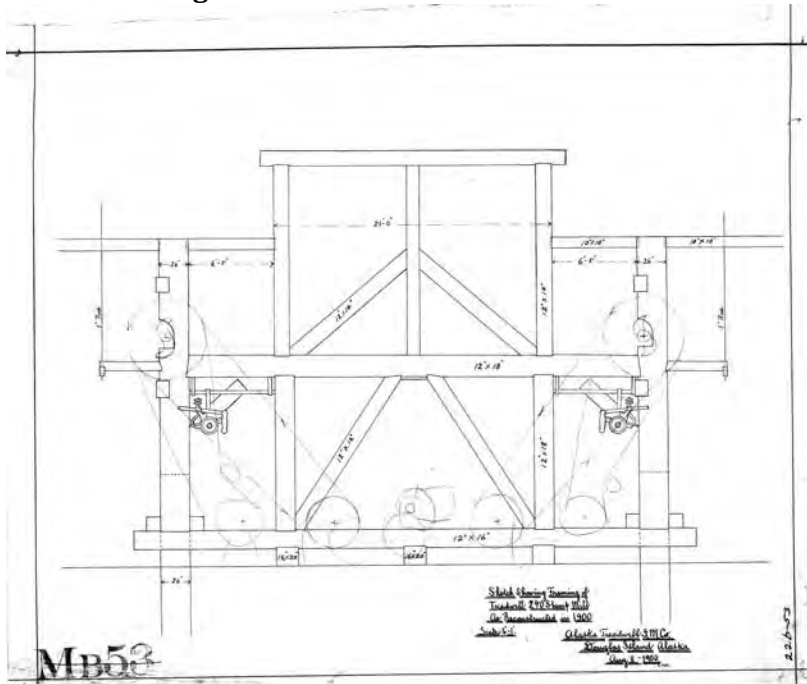

Sketch showing framing of Treadwell 240 Stamp Mill as reconstructed in 1900, dated August 1900; drawing courtesy of Alaska State Library Historical Collection, AJT Collection



Concrete foundation and electrical generation equipment from 240 Power House, November 2009; photo courtesy of Wayne Jensen.

TREADWELL HISTORIC DISTRICT

240 STAMP MILL

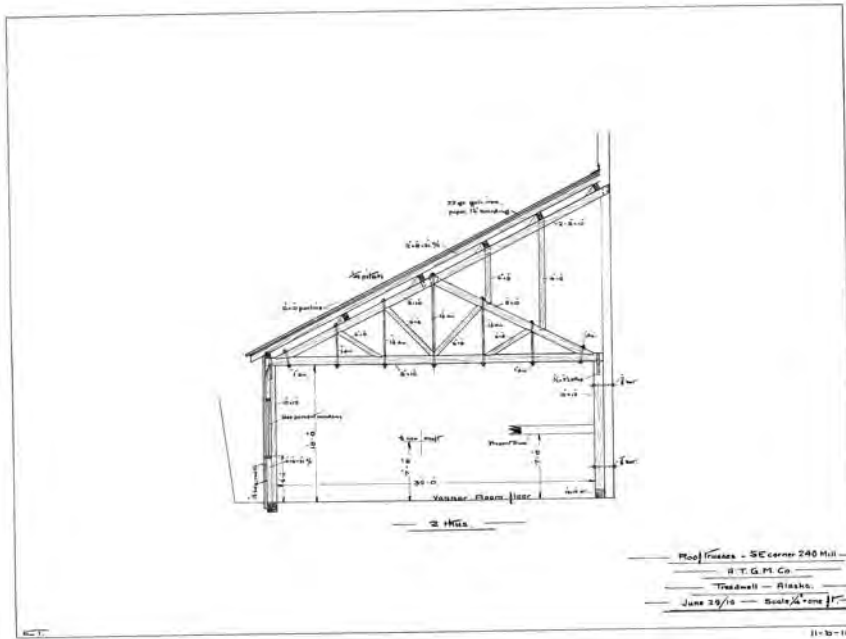

Roof Truss Southeast Corner of 240 Mill, 1900;
Drawing courtesy of Alaska State Library Historical Collection, AJT Collection

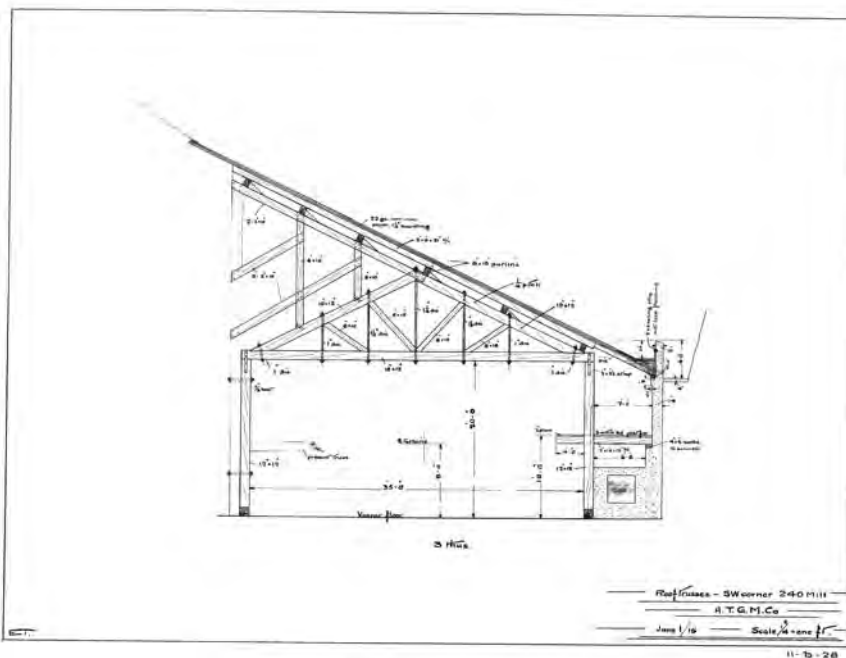

Roof Truss Southwest Corner of 240 Mill, 1900;
Drawing courtesy of Alaska State Library Historical Collection, AJT Collection

TREADWELL HISTORIC DISTRICT

TREADWELL HOIST

AHRS#: **CBJ#:** **Parcel#:** **Year Built:**

2-D03-0-102-006-1

Historic Name: Treadwell Hoist

Other Name:

Location: Treadwell Mine

Legal Description:

Historic Use: Ore Processing

Current Use: N/A

Architectural Style:

General Description: The hoist raised and lowered men and ore through the vertical shaft located between the 240 mill and the Glory Hole. Today the concrete foundations and pieces of the hoisting equipment and cables exist.

Architectural Features:

Historical Information:

Alterations:

Comments:

Entry Date: 7/2/2010

Survey By: Wayne Jensen

TREADWELL HISTORIC DISTRICT

TREADWELL HOIST



Foundations from Treadwell Hoist, November 2009
Photo Courtesy of Wayne Jensen



Cable from Treadwell Hoist
Photo courtesy of Wayne Jensen

TREADWELL HISTORIC DISTRICT

BLACKSMITH SHOP

AHRS#: **CBJ#:** **Parcel#:** **Year Built:**

2-D03-0-102-006-1

Historic Name: Blacksmith Shop

Other Name:

Location: Treadwell

Legal Description:

Historic Use: Metal Fabrication and Repair

Current Use:

Architectural Style:

General Description: Located south of the 240 Mill. There are several artifacts in the vicinity of the Blacksmith Shop including an Ore Car, metal lathe and large solid steel anvil plate.

Architectural Features:

Historical Information:

Alterations:

Comments:

Entry Date: 07/08/10

Survey By: Wayne Jensen

TREADWELL HISTORIC DISTRICT

BLACKSMITH SHOP



Blacksmith Building Site, April 2010; Metal lathe on right side of photo.
Photo courtesy of Wayne Jensen



Ore car on track near Blacksmith Shop, April 2010
Photo courtesy of Wayne Jensen

TREADWELL HISTORIC DISTRICT

BLACKSMITH SHOP



Metal Lathe remains April 2010;
Photo courtesy of Wayne Jensen



Part of Metal Lathe with foundry mark indicating it was cast at the Treadwell Foundry.
Photo taken in April 2010, courtesy of Wayne Jensen

TREADWELL HISTORIC DISTRICT

BLACKSMITH SHOP



Anvil table remains, April 2010;
Photo courtesy of Wayne Jensen



Ladle Remains, April 2010,
Photo courtesy of Wayne Jensen

TREADWELL HISTORIC DISTRICT

GLORY HOLE

AHRS#: **CBJ#:** **Parcel#:** **Year Built:**
2-D03-0-102-006-1
Historic Name: Glory Hole **Other Name:**
Location:Treadwell **Legal Description:**
Historic Use: Open Pit Mine **Current Use:**

Architectural Style:

General Description: The “Glory Hole” open pit mine is located south of the 240 Mill. It is approximately 1,700 feet by 420 feet across and 450 feet deep. The hole still exists.

Architectural Features:

Historical Information: The “Glory Hole” an open pit mine was the initial location of the lode mining in the Treadwell area. The pit operated until 1906, when all workings in the pit ceased, when the companies began to excavate the ore by tunneling deep within the ground. Approximately 5 million tons of ore were removed from the pit.

Alterations:

Comments:

Entry Date: 07/13/10

Survey By: Wayne Jensen

TREADWELL HISTORIC DISTRICT

GLORY HOLE



Glory Hole circa 1910, photographer Winter & Pond
Alaska State Library, Winter & Pond Collection, ASL-P87-0350

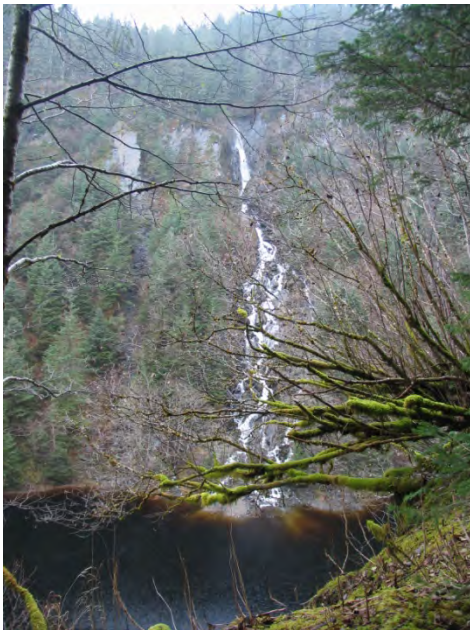

Glory Hole, November 2009
Photo courtesy of Wayne Jensen

TREADWELL HISTORIC DISTRICT

TANKS

AHRS#: **CBJ#:** **Parcel#:** **Year Built:** N/A

2-D03-0-102-006-1

Historic Name: Tanks

Other Name:

Location: Treadwell

Legal Description:

Historic Use: Water and Fuel Storage

Current Use:

Architectural Style: N/A

General Description: Riveted steel plate tanks used to store crude oil delivered by ship to the Wharf. One was located near the end of the Wharf, one next to the Central Power Plant and a third on the hill west of the 240 Mill. A fourth tank served the boilers for the Central Hoist and 700 Mill, this tank collapsed in the cave-in in 1917. Steel tanks were also used to store salt water for use in the mills and for fire fighting.

Architectural Features: N/A

Historical Information: The tanks were made of steel segments riveted together. The small ones could hold 10,000 barrels of oil and the large ones approximately 30,000 barrels.

Alterations:

Comments:

Entry Date: 07/08/10

Current Photo Date and Author:

Survey By: Wayne Jensen

TREADWELL HISTORIC DISTRICT

TANKS



Crude Oil Tank

Salt Water Tank

Photo Courtesy of Juneau Douglas City Museum

Photos courtesy of Alaska State Library Historical Collections , Case & Draper Collection

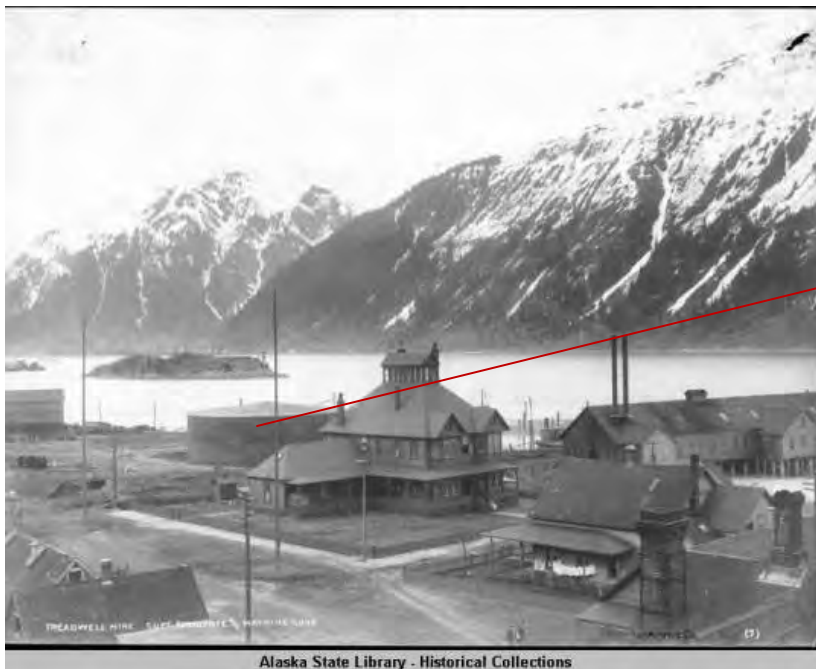

Crude Oil Tank

TREADWELL HISTORIC DISTRICT

TANKS

Historic Image:

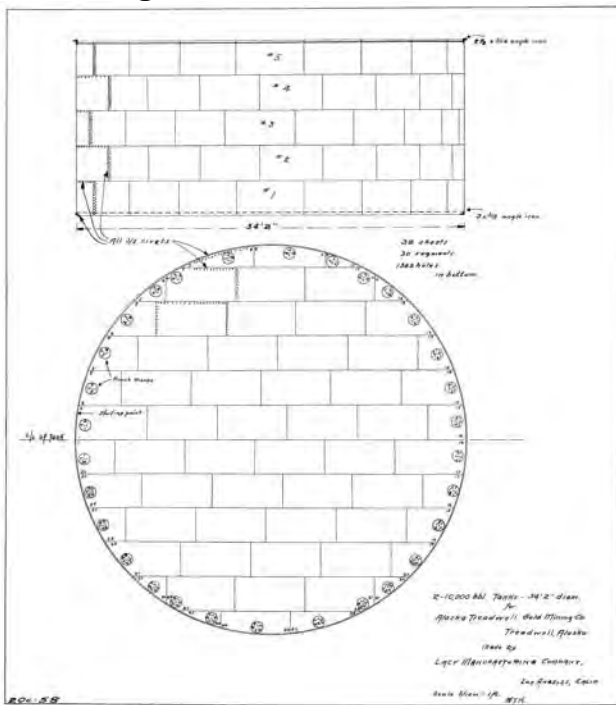

Drawing of 10,000 barrel oil tank

Drawing courtesy of Alaska State Library Historical Collections, AJT Collection

Current Image:



Site of crude oil tank for Central Power Plant. Imprint of tank still existing along with steel perimeter base angle. Photo courtesy of Wayne Jensen

TREADWELL HISTORIC DISTRICT

TREADWELL DITCH

AHRS#: **CBJ#:** **Parcel#:** **Year Built:**
2-D03-0-102-006-1
Historic Name: Treadwell Ditch **Other Name:** Treadwell Pipeline, 300 Pipeline

Location: Treadwell Mine **Legal Description:**

Historic Use: Water for Power Generation & Processing **Current Use:** N/A

Architectural Style:

General Description: Water was collected from streams from the east side of Douglas Island and delivered to Treadwell by the Treadwell Ditch, an 18 mile ditch. Water power provided energy for electrical generation and processing. When water was not available coal or crude oil was used.

Architectural Features:

Historical Information:

Alterations:

Comments:

Entry Date: 7/2/2010

Current Photo Date and Author:

Survey By: Wayne Jensen



**Tailings or wastewater flume from 240
Mill near Treadwell Club**
Photo by Wayne Jensen

**Pipeline to 240 Mill from
Treadwell Ditch**

Photo by Wayne Jensen





Pipeline to 240 Mill from Treadwell Ditch
Photo by Wayne Jensen

Wood Stave Pipe
Photo by Wayne Jensen



TREADWELL HISTORIC DISTRICT

CAVE IN



Photo of Cave-in April 22, 1917

Photo courtesy of Juneau Douglas City Museum



Photo of Cave-in at high tide April 22, 1917

Photo courtesy of Juneau Douglas City Museum

TREADWELL HISTORIC DISTRICT

CAVE IN



Natorium, one day after cave-in, April 23, 1917

Photo courtesy of Juneau Douglas City Museum



Swimming tank following cave-in

Photo courtesy of Juneau Douglas City Museum

BEST MANAGEMENT PRACTICES

The Treadwell Mining Complex Historic Resources and Site Survey provides information on the existing and former buildings and structures in the portion of the Treadwell Complex on Douglas Island currently owned by the City and Borough of Juneau. This includes observations of the condition of the existing buildings and structures. The purpose of this information will be to assist in the management of this historic property.

Objectives:

- To protect and manage historic resources within the portion of the historic Treadwell Mining Complex owned by the City and Borough of Juneau.
- To provide educational information about the history of mining and the Treadwell Mining Complex.

Context:

Historic resources exist throughout the State of Alaska and the City and Borough of Juneau. The Treadwell Mining Complex represents one of the more significant sites in the CBJ. It was the site of the largest gold mine in the world during its existence in the late 19th and early 20th centuries. It is part of a popular recreation area and is easily accessed via a network of trails. It is rich with artifacts, remnants of buildings and land forms that recall the mining history of the time and area. Best Management Practices can assist in the protection and appreciation of this rich heritage.

BEST MANAGEMENT PRACTICES:

General:

- The Treadwell Historic Preservation and Restoration Society (Treadwell Society), Inc. was established in 2009 to stabilize, preserve and restore the existing structures and buildings of the Treadwell Mine site on Douglas Island for the purpose of public access, education and enjoyment. A Memorandum of Agreement between the City and Borough of Juneau (CBJ), the owner of the property, and the Treadwell Society grants the Treadwell Society the right to manage the property for public use and to assist in the restoration and preservation of historical structures on the property.

Site Improvements:

- Locations of non-existing buildings and structures should be identified to avoid detrimental impacts to historic resources.
- Objects and artifacts discovered during routine maintenance or new construction shall be brought to the attention of the Society for disposition as provided in the Memorandum of Agreement between the Treadwell Society and the CBJ.

Restoration, Rehabilitation and/or Replication of Historic Buildings and Structures:

- Stabilize existing buildings and structures to prevent further deterioration.
- Preserve the original appearance of existing buildings and structures during any restoration.
- Use materials consistent with the original construction.

BEST MANAGEMENT PRACTICES

- Construction shall be consistent with the Secretary of the Interior's Standards and Guidelines.
- Vegetation in and around historic resources should be cleared to protect the resources from detrimental impacts.

Site Use and Events:

- Public use of the CBJ owned portion of the Treadwell Mining Complex should be managed in a manner that assures protection of the historic resources.
- Identify appropriate locations for events and activities that assure protection of the historic resources.

Education:

- The public should be notified through education and signs on the site that damage to the buildings and structures and the removal of objects from the site is illegal.
- The Treadwell Society, in cooperating with the CBJ Parks and Recreation Department, will make its best effort to educate the public of the importance to protect the site from loss of historic resources, and to conserve the property so as to minimize damage to the extant buildings, structures, sites and objects.
- Educate the public about the history of the site and the importance of preserving it.

BIBLIOGRAPHY

The following resources were utilized in the development of this report:

I. Publications

Draft Report of the Treadwell Historic Resources Survey, 1991

Gary Gillette and Willette Janes

History of the Mine and Miners in the Juneau Goldbelt, 1988

Earl Redman

I Remember Treadwell, 1983

Charlotte L. Mahaffy

History of Gold Mining Sites Juneau, Alaska 1980

Heritage Conservation and Recreation Service

Hard Rock Gold, 1980

David and Brenda Stone

Treadwell Gold, 2010

Sheila Kelly

II. Data Repositories

Alaska State Historical Library

Alaska's Digital Archives

Juneau Douglas City Museum