

Standard Operating Procedures
Oxides of Nitrogen
(NO/NO_x/NO₂) Monitoring
in Ambient Air by
Chemiluminescence

Air Quality Division

Air Monitoring
&
Quality Assurance
Program

555 Cordova Street
Anchorage, AK 99501

Phone: (907) 269-7577

Fax: (907) 269-7508

www.state.ak.us/dec/



Barbara Trost, Program Manager

Date: _____

Daniel Fremgen, Quality Assurance Officer

Date: _____

Revision 2
June 2016

This page intentionally left blank



DEC Air Monitoring & Quality Assurance Program
SOP –NO/NO_x/NO₂ Monitoring by Chemiluminescence

Revision 2, June 2016

Acknowledgement

The State of Alaska Department of Environmental Conservation (DEC) wishes to thank current staff members from the Air Monitoring and Quality Assurance (AMQA) program for their assistance in the preparation of this SOP.

Disclaimer

Any mention of equipment manufacturers, instrument or equipment model numbers, commercial vendors or suppliers does not represent an endorsement by the State of Alaska or the Department of Environmental Conservation.



TABLE OF CONTENTS

.....	1
<i>Acknowledgement</i>	1
<i>Disclaimer</i>	1
1. PURPOSE AND SCOPE	1
2. APPLICABILITY	1
3. SUMMARY OF METHOD	2
3.1 Analytical Technique	2
3.2 Interferences	4
3.3 Basic Monitoring System Configuration.....	4
3.4 Health and Safety Precautions.....	5
4. QUALITY CONTROL VERSUS QUALITY ASSURANCE	5
4.1 Calibration versus Verification	6
4.2 Full Scale versus Calibration Scale.....	7
5. STARTUP PROCEDURES	8
5.1 Equipment Acquisition, Inspection, and Testing	8
5.2 Installation Procedures	9
5.3 Data Documentation & Recordkeeping Procedures.....	9
5.4 Operator Training.....	10
6. OPERATIONAL PROCEDURES	10
6.1 Calibration Procedures for the NO/NO _x /NO ₂ Analyzer	10
6.1.1 Calibration procedures using a dynamic dilution calibration system with a GPT	11
6.1.2 Adjustment of Background.....	12
6.1.3 Adjustment of the NO Channel.....	12
6.1.4 Adjustment of the NO _x Channel.....	15
6.1.5 Confirmation of Instrument Linearity for NO/NO _x Channels.....	16
6.1.6 Adjustment of the NO ₂ Channel	17
6.1.7 Confirmation of Instrument Linearity for NO ₂ Channel.....	18
6.1.8 Calculation of the NO ₂ Converter Efficiency	19



DEC Air Monitoring & Quality Assurance Program
SOP –NO/NO_x/NO₂ Monitoring by Chemiluminescence

Revision 2, June 2016

6.2	Routine Operational Checks.....	20
6.2.1	Shelter Temperature.....	20
6.2.2	Sample System Inspection.....	20
6.2.3	Gas Cylinder Inspection.....	22
6.2.4	Zero Air Generator Checks.....	22
6.2.5	Multi-gas Calibrator Checks.....	22
6.2.6	Analyzer Status Checks.....	23
6.2.7	Data Acquisition System (DAS) Checks.....	23
6.3	Routine QC Performance Verification Checks.....	23
6.3.1	Zero/Span Checks.....	24
6.3.2	Precision Checks.....	25
6.3.3	Routine Multi-Point Verifications.....	25
6.3.5	Performance Verification QC Limits.....	26
6.4	Corrective Actions.....	26
6.5	Preventative Maintenance.....	28
7.	QUALITY ASSURANCE.....	29
7.1	Qualification, Verification and Re-verification.....	29
7.2	Data Quality Indicators.....	29
7.3	Performance Audits.....	30
7.4	Technical System Audits.....	30
8.	DATA REVIEW, VALIDATION AND REPORTING.....	34
8.1	Data Acquisition.....	34
8.2	Daily Review.....	35
8.3	Level 1 Data Review, Editing, and Data Archiving.....	35
8.3.1	Data Review.....	35
8.3.2	Data Editing.....	36
8.3.3	Data Archiving.....	37
8.4	Level 2 Data Review and Validation.....	37
8.5	Data Submission to EPA AQS.....	38



DEC Air Monitoring & Quality Assurance Program
SOP –NO/NO_x/NO₂ Monitoring by Chemiluminescence

Revision 2, June 2016

8.6	Annual Summary Reports	38
9.	REFERENCES.....	39
10.	DEFINITIONS OF ACRONYMS & SYMBOLS.....	40



List of Figures

Figure 1 Typical flow schematic of a NO/NO_x/NO₂ chemiluminescence analyzer. (Courtesy of Thermo Fisher Scientific Environmental Instruments)..... 3

Figure 2 Typical equipment configuration of an NO/NO_x/NO₂ monitoring system..... 4

Figure 3 NO/NO_x/NO₂ Calibration Data Sheet (Page 1 of 2) 13

Figure 4 NO/NO_x/NO₂ Calibration Data Sheet (Page 2 of 2) 14

Figure 5 NO/NO_x/NO₂ Monitoring Program Operational Checklist 21

Figure 6 Example NO Audit Results 31

Figure 7 Example NO_x Audit Results 32

Figure 8 Example NO₂ Audit Results 33

Figure 9 NO₂ Converter Efficiency Audit Results 34

List of Equations

Equation 1 Reaction of NO and O₃ to produce NO₂ and O₂ plus a characteristic luminescences 2

Equation 2 Calculation of [NO]_{OUT} 12

Equation 3 Conversion of ppm to ppb 12

Equation 4 Calculation of [NO_x]_{OUT} 15

Equation 5 Least squares regression equation for calculation of best-fit calibration line 17

Equation 6 Calculation of percentage difference (di) 17

Equation 7 Calculation of [NO₂]_{OUT} 18

Equation 8 Calculation of the NO₂ converter efficiency 19

Equation 9 Calculation of zero drift..... 24

List of Tables

Table 1 Corrective Action Thresholds for the NO/NO_x/NO₂ Analyzer 27

Table 2 Example Preventive Maintenance Schedule..... 28



1. PURPOSE AND SCOPE

This document shall establish standard operating procedures (SOP) for the collection, review, processing, and reporting of ambient air quality monitoring data for the oxidized forms of nitrogen specifically nitric oxide, total oxides of nitrogen and nitrogen dioxide, often abbreviated as (NO/NO_x/NO₂). These standard procedures will be applicable to data collected by the Alaska Department of Environmental Conservation (DEC) or subject to a regulatory review by DEC.

2. APPLICABILITY

This document provides the basic procedures to collect ambient air quality NO/NO_x/NO₂ monitoring data in accordance with federal regulations and EPA quality assurance/quality control (QA/QC) requirements. This document is specific to NO/NO_x/NO₂ monitoring programs which use *chemiluminescence* as the measurement technology. This document is generic in that it does not address site specific issues.

This document shall serve as:

- the SOP document for all NO/NO_x/NO₂ monitoring performed by DEC or other local air pollution control agencies to determine compliance with the National Ambient Air Quality Standards (NAAQS), that is all state and local air monitoring station (SLAMS) networks;
- the SOP document for all trace-level NO/NO_x/NO₂ monitoring performed by DEC or other local air pollution control agencies such as for multi-pollutant NCORE monitoring sites; and
- the SOP document for NO/NO_x/NO₂ special purpose monitoring station (SPMS) performed by DEC or other local air pollution control agencies.

This document may serve as:

- a generic template for industry, monitoring contractors, or other community based monitoring programs in the development of a site-specific SOP.

Please note that each industry, monitoring contractor, or community organization tasked with the installation, operation, and reporting of regulatory monitoring data is strongly encouraged to develop a comprehensive site-specific SOP document. While this SOP provides generic operating procedures to ensure compliance with monitoring regulations and EPA guidance, a site-specific SOP should integrate these procedures with detailed information regarding the makes and models of the NO/NO_x/NO₂ analyzer, calibration system, and data acquisition system, as well as specific information regarding monitoring site location, shelter specifications, and siting requirements. It is incumbent upon the preparer to incorporate the most current updates to federal regulations, EPA requirements, or new equipment technologies.



This SOP document, at the date of issuance, represents the latest information on NO/NO_x/NO₂ monitoring in regards to federal regulations as published in *Title 40 of the Code of Federal Regulations (Parts 50, 52, 53, and 58)* and EPA requirements as listed in the *EPA Quality Assurance Handbook for Air Pollution Measurements, Volume II, Ambient Air Monitoring Program, May 2013*.

3. SUMMARY OF METHOD

While there are a number of technologies used in the measurement of ambient air concentrations of NO/NO_x/NO₂, the method employing chemiluminescence has been in use since the mid-1970s and has become the industry standard for EPA NO/NO_x/NO₂ ambient air monitoring. For the purpose of this SOP, the procedures described are applicable specifically to chemiluminescence instruments.

3.1 Analytical Technique

The principle of operation of this instrument is based on the gas-phase reaction of NO and O₃. This reaction produces a characteristic luminescence with an intensity linearly proportional to the NO concentration. Upon the reaction of NO and O₃ to produce NO₂ and O₂, the NO₂ molecule become electronically excited. The near infrared light emissions result when the excited NO₂ molecules decay to a lower ground state energy level. The reaction is presented in **Equation 1**.

Equation 1 Reaction of NO and O₃ to produce NO₂ and O₂ plus a characteristic luminescences

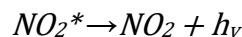
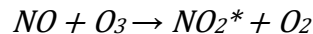

Where: NO = molecule of nitric oxide

O₃ = molecule of ozone

NO₂* = energized molecule of nitrogen dioxide

NO₂ = molecule of nitrogen dioxide at ground state energy

O₂ = molecule of oxygen

h_ν = characteristic luminescences emitted as the NO₂ molecule decays to a lower energy state.

NO_x compounds, other than NO (i.e. NO₂ and NO₃), must first be transformed into NO before they can be measured using the chemiluminescence reaction. The NO_x compounds are converted by drawing the sample gas through a NO₂ to NO molybdenum converter heated to 325° C. The molybdenum converter will convert all the NO_x compounds in the sample stream to NO. When reacted with O₃ in the reaction chamber to produce the characteristic chemiluminescence, the sample will represents a total concentration of all the combined NO_x compounds. The analyzer is a dual channel instrument drawing sample gas through



SOP –NO/NO_x/NO₂ Monitoring by Chemiluminescence

Revision 2, June 2016

molymdenum converter to the reaction chamber to measure total NO_x and then switching a solenoid valve to draw sample gas which bypasses the converter to go directly to the reaction chamber to measure NO. The resulting chemiluminescence light emission produced in the reaction chamber passes through a filtered lens and is detected by a photomultiplier tube (PMT) contained within a thermo-electric cooler. The PMT produces a signal which is amplified and sent to an on-board microprocessor. A third mode routes sample gas through a pre-reactor where the sample gas is reacted with O₃ prior to the reaction chamber. This is to create a dynamic zero reading for the analyzer reference. Each measurement is converted to a concentration and stored in memory. The micro-processor uses the NO_x measurement and NO measurement to calculate the difference (NO₂) between the two concentration values. The on-board microprocessor times the measurements by switching the solenoid valves. Ozone is generated by drawing room air through a particulate filter and a dryer to remove moisture. The clean dry air is then drawn through an UV light ozonator to produce the excess of O₃ gas required for gas-phase reaction. Sample flow is typically controlled by critical orifices with digital transducers to measure and compensate for temperature and pressure. Sample and dry air flow through the analyzer is accomplished by an external vacuum pump.

Figure 1 presents a flow schematic of a typical NO/NO_x/NO₂ instrument configuration.

Figure 1 Typical flow schematic of a NO/NO_x/NO₂ chemiluminescence analyzer. (Courtesy of Thermo Fisher Scientific Environmental Instruments)

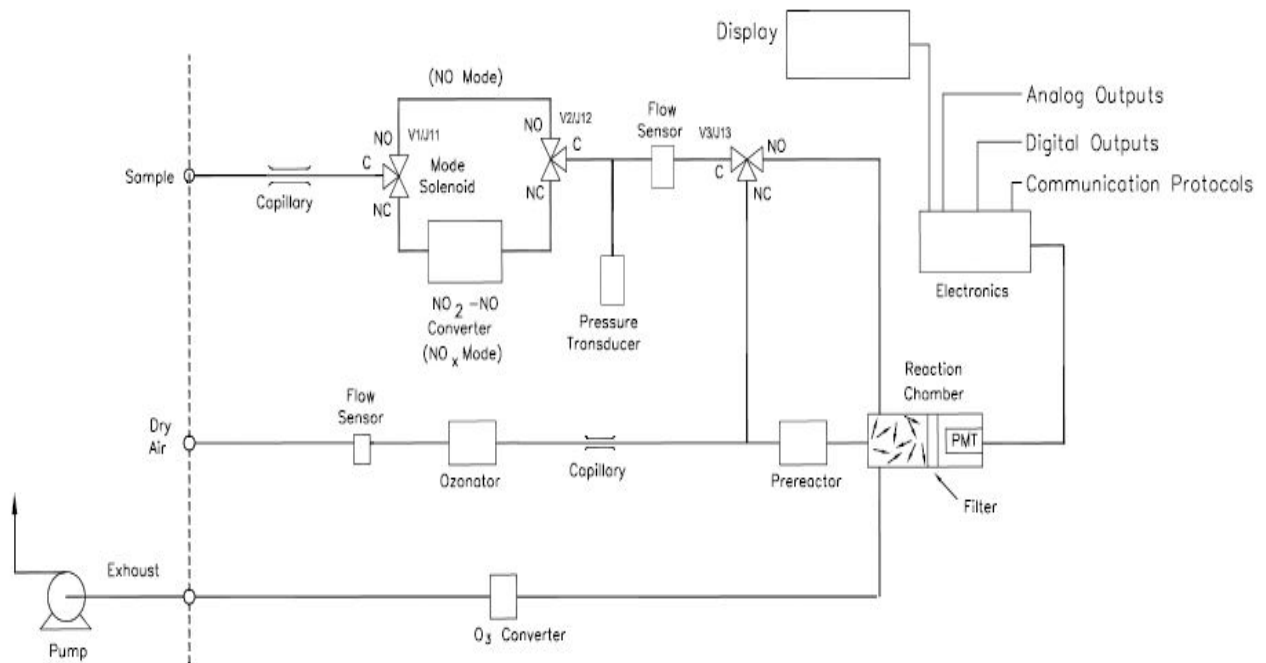



3.2 Interferences

Direct analytical interference for NO/NO_x/NO₂ chemiluminescence analyzers results from other gases present in the sample gas that produce a luminescence when reacted with O₃ or other nitrogen-containing molecules that will potentially be converted to NO by the heated converter. These interferences are rejected by two instrumental methods:

1. use of pre-reactor flow mode to eliminate the interference as background luminescence, or
2. use of a frequency specific bandpass optical filter that only allows the near infrared decay radiation for NO₂ to pass into the photomultiplier tube while blocking the decay radiation from other chemiluminescent reactions.

3.3 Basic Monitoring System Configuration

An air monitoring station contains instruments and equipment linked together to form a functional system that will sample, measure, calibrate, record, and store ambient air data.

Figure 2 presents a basic configuration of NO/NO_x/NO₂ monitoring system components.

Figure 2 Typical equipment configuration of an NO/NO_x/NO₂ monitoring system

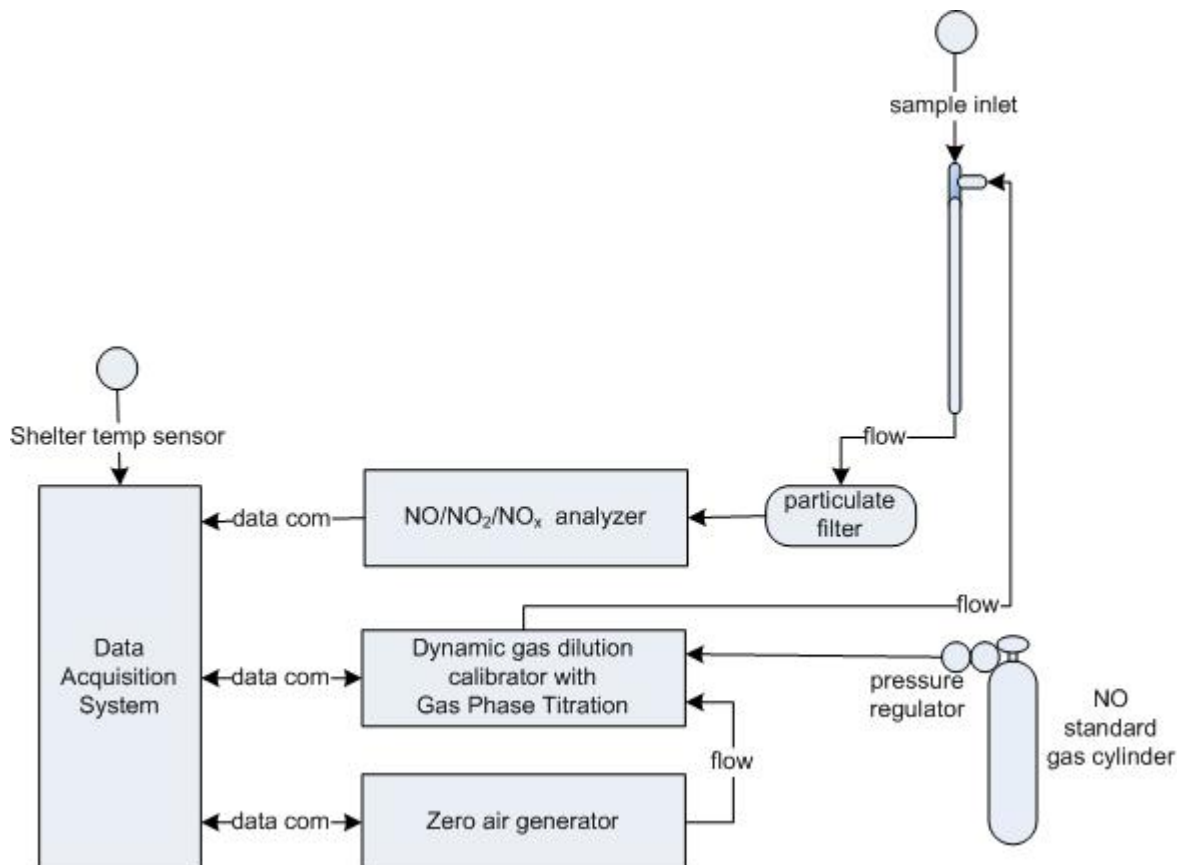



DEC Air Monitoring & Quality Assurance Program
SOP –NO/NO_x/NO₂ Monitoring by Chemiluminescence

Revision 2, June 2016

Specific information regarding site selection, monitoring shelter and equipment specifications, data measurement quality objectives are provided in the *Quality Assurance Project Plan for the State of Alaska Air Monitoring & Quality Assurance Program*.¹

3.4 Health and Safety Precautions

The following basic precautions should be taken while working with monitoring instrumentation and equipment:

1. Properly exhaust any gas output from the NO/NO_x/NO₂ analyzer and any excess gas generated from the calibration system to the outside of the monitoring shelter.
2. Assure that all electrical power connections for the monitoring instrumentation and auxiliary equipment are properly grounded with a 3-wire plug.
3. All exterior power circuits must include a ground-fault interrupter.
4. When working on, troubleshooting, or repairing any electrical instrumentation or equipment, the technician should remove any jewelry (rings, necklaces or chains) or other personal items which could conduct electricity and result in electrical shock or damage to equipment.
5. Before beginning any repair of electrical instrumentation or equipment (unless otherwise indicated by the equipment service manual), the power shall be turned off and the power cord disconnected.
6. When working on electronic instrumentation and components, the use of an anti-static wristband or floor mat is highly recommended. Properly grounded, these devices will reduce the risk of a static electric discharge which could result in an electrical shock and damage to sensitive electronic components.

The instruments should be placed on a stable bench surface or in an instrument rack with at least 4 inches clearance in the back and 1 inch clearance for the sides, above and below. They must not be placed against heaters or air conditioners. Other routine safety practices shall be observed for the monitoring shelter: the fire extinguisher shall be routinely inspected and serviced; the shelter shall be organized and free of clutter for ease of entry and exit; the electrical service panel shall have unencumbered access; and all walking surfaces, platforms, and ladders shall be maintained to avoid slip and fall hazards.

4. QUALITY CONTROL VERSUS QUALITY ASSURANCE

Care must be taken not to equate Quality Control (QC) with Quality Assurance (QA). Though the two are very similar, there are some basic differences: QC is concerned with the end product (i.e., the resulting pollutant data), while QA is process or system oriented. Hence, QC is a subset of QA. As an example, preparation of this standard operating procedure is a QA

¹ Quality Assurance Project Plan for the State of Alaska Air Monitoring and Quality Assurance Program, DEC February 23, 2010; http://dec.alaska.gov/air/doc/ADEC_AMQA_QAPP_23FEB-final.pdf



function because it is to ensure strict adherence by site operators to a system or process intended to assure data quality. Another example of a QA document is the *Quality Assurance Project Plan (QAPP) for State of Alaska Air Monitoring & Quality Assurance Program*². This document sets the data quality objective for the ADEC statewide monitoring system.

Routine analyzer calibrations, data verifications, and status checks are QC functions because these checks are on-going technical assessments of the product, i.e., the data. Most of the procedures described in this document are QC procedures. Acceptance criteria for routine QC checks are presented in *EPA Quality Assurance Handbook for Air Pollution Measurements, Volume II, Ambient Air Monitoring Program, May 2013, Appendix D, NO/NO_x/NO₂ Data Validation Template*³. A copy of the NO/NO_x/NO₂ data validation template is presented in **Appendix A** of this document.

4.1 Calibration versus Verification

Calibration is defined as: “*the comparison of a measurement standard, instrument, or item with a standard or instrument of higher accuracy to detect and quantify inaccuracies and to report or eliminate those inaccuracies by adjustment*”⁴. For an NO/NO_x/NO₂ monitoring program, an adjusted calibration of the analyzer shall be performed:

- upon initial installation and prior to commencing data collection;
- following physical relocation;
- after any repairs or service that might affect its calibration;
- following an interruption in operation of more than a few days;
- upon any indication of analyzer malfunction or change in calibration; and,
- at some routine interval as required by QC operational criteria and the QAPP.

The same principle would be true for calibration of any other system measurement devices. See the NO/NO_x/NO₂ Data Validation template in **Appendix A** for specific calibration frequency requirements.

Where a “*calibration*” is associated with an adjustment, a “*verification*” check is a standard comparison to assess on-going data quality and is performed ***without correction***. Verification checks are typically QC procedures performed on a prescribed routine schedule or when some event would necessitate a data assessment. Examples would be: a routine six-month multi-

² Quality Assurance Project Plan for the State of Alaska Air Monitoring & Quality Assurance Program, February 23, 2010. http://dec.alaska.gov/air/doc/ADEC_AMQA_QAPP_23FEB10-final.pdf

³ EPA Quality Assurance Handbook for Air Pollution Measurements, Volume II, Ambient Air Monitoring Program, EPA-454/B-13-003, May 2013. <https://www3.epa.gov/ttnamti1/files/ambient/pm25/qa/QA-Handbook-Vol-II.pdf>

⁴ American National Standard Quality Systems for Environmental Data and Technology Programs ANSI/ASQ E4 <http://www.asq.org/>



DEC Air Monitoring & Quality Assurance Program
SOP –NO/NO_x/NO₂ Monitoring by Chemiluminescence

Revision 2, June 2016

point verification of a NO/NO_x/NO₂ analyzer performed to assess data accuracy and linearity; or single point QC checks for zero/span/precision after a prolonged power outage at a station.

IMPORTANT NOTE: *To properly assess data quality over time, there shall be an initial calibration followed by routine verifications. For the purposes of data review and validation, this establishes the data quality from the beginning of the period with a traceable standard to the time of the verification check where the data quality are again assessed with a traceable standard. This is often referred to as “bracketing the data.” Whenever a measurement device fails a QC performance check or the device becomes inoperable, the data are invalidated from that time the analyzer or system component is repaired and data validity assured back to the last verification check or calibration which passed QC criteria. Unless the measurement device has totally failed, a verification check shall be performed before any adjustment or repair.*

Other common jargon used for verification and calibration procedures are “As Found” and “As Left.” “As Found” would be a verification check to assess data quality without correction. “As Left” would refer to the data quality once an adjustment had been successfully made and instrument returned to acceptable performance criteria. As with verification and calibration, “As Found” and “As Left” relate to bracketing a set of data for the purpose of review and validation.

4.2 Full Scale versus Calibration Scale

Many previous EPA documents and some CFR reference methods refer to calibration at “full scale,” which was interpreted as a multi-point calibration that would be performed over the entire measurement range of the instrument using five evenly spaced points from 80 percent of full scale down to zero. For example, most NO/NO_x/NO₂ analyzers with a selected measurement range of 0 to 500 parts per billion (ppb) would be calibrated at concentrations of 400 ppb, 300 ppb, 200 ppb, 100 ppb, and zero air. However, the primary NO/NO_x/NO₂ NAAQS is established at a 1-hour average of 75 ppb. For the State of Alaska, most NO/NO_x/NO₂ concentrations will be recorded at less than 50 ppb. The analyzer response to the above calibration concentrations do not provide much information regarding the stability and accuracy within the range of observed measurements. The EPA suggests monitoring organizations calibrate using points that are more applicable to observed measurements while maintaining a measurement range to assess concentrations above the NAAQS. For example, a more applicable calibration scenarios might be to reduce the instrument measurement scale from 0 to 500 ppb to 0 to 300 ppb with calibration points performed at 240 ppb, 180 ppb, 120 ppb, and 60 ppb. To adapt to this change in focus, the EPA is now using the term “*calibration scale*” to refer to the concentration range used to calibrate or verify a monitoring instrument.



5. STARTUP PROCEDURES

5.1 Equipment Acquisition, Inspection, and Testing

Prior to startup of any monitoring program all system components will need to be acquired, thoroughly inspected, tested, and the monitoring personnel thoroughly trained. In the case of a gas analyzer, the instrument must be designated as a federal equivalent method (FEM) in accordance with 40 CFR 53.⁵ The dynamic calibration system, zero air generator, and data acquisition system (DAS) must be capable of meeting the specifications as discussed in EPA *Quality Assurance Handbook for Air Pollution Measurement Systems, Volume II, Ambient Air Quality Monitoring Programs*.⁶ All reference gas standards shall be certified in accordance with the *EPA Traceability Protocol for Assay and Certification of Gaseous Calibration Standards*.⁷

Each component instrument or device must be thoroughly inspected and functionality verified. New instruments should be carefully unpacked and inspected for damage resulting from shipping. Previously used instruments and devices shall have maintenance logs reviewed to assess time in service, compliance with scheduled maintenance, previous system problems, and parts replacement. All used equipment shall have maintenance and parts replaced as determined appropriate by the inspection.

In addition to the main system components, an inventory of manufacturer recommended spare parts shall be ordered and maintained throughout the project.

Each instrument or device must be prepared and bench tested prior to start up. This is to ensure that the instrument or device is fully functional, operating within technical specifications, and traceable to the National Institute of Standards and Technology (NIST.) For specific procedures consult the equipment manufacturer's operating/service manuals.

For calibration systems this will involve leak testing and calibration of mass flow controllers to ensure the accuracy of all flow. To conduct NO₂ calibrations, function of gas phase titration ozonator or permeation systems shall be verified. Initial programming of micro-processor controls shall be completed to configure the concentration of standard gases for manual and automated gas blending functions, event scheduling, and telemetry for data communication.

⁵ Title 40 of the Code of Federal Regulations, Part 53, Ambient Air Monitoring Reference and Equivalent Methods <http://www.epa.gov/ttn/amtic/files/ambient/criteria/reference-equivalent-methods-list.pdf>

⁶ USEPA Quality Assurance Handbook for Air Pollution Measurement Systems, Volume II, Ambient Air Quality Monitoring Program, EPA-454/B-13-003, May 2013
<http://www.epa.gov/ttn/amtic/files/ambient/pm25/qa/QA-Handbook-Vol-II.pdf>

⁷ EPA Traceability Protocol for Assay and Certification of Gaseous Standards, EPA 600/R-012/533, May 2012,
[Document Display | NSCEP | US EPA](#)



DEC Air Monitoring & Quality Assurance Program
SOP –NO/NO_x/NO₂ Monitoring by Chemiluminescence

Revision 2, June 2016

For zero air generators this will involve leak testing, compression pump testing, functionality of pressure relief valves and moisture drain valves, functionality of heated catalysts, and replacement of filters and chemical scrubber media. Comparison testing to a certified ultra-pure zero air cylinder is strongly encouraged.

The DAS unit's initial programming must be completed to configure all signal input channels and to ensure all calculations for converting electrical (or digital) signals to appropriate engineering units. All signal inputs must be assessed to ensure accurate data transfer from the analyzer and other devices to data memory. The DAS shall also be checked to assess data communications between the monitoring site and base computers or database servers.

Step by step procedures to complete the above tasks will be presented in detail by the manufacturer's operational and service manuals for each specific instrument and device.

5.2 Installation Procedures

Once all monitoring components have been tested for proper functionality, and all standards traceability established, on-site installation can begin.

The analyzer, calibration system, zero air generator, and DAS may be mounted in standard 19-inch instrument racks or bench mounted. In either case, ease of accessibility for power, sample flow, and data connections, as well as access for equipment maintenance is an essential consideration. Sample flow connections shall be as short as practical to meet sample residence time. Compressed gas cylinders must be thoroughly secured in accordance with applicable safety regulations. The room or shelter temperature sensor must be located to provide representative data for the monitoring system environment and certified as traceable to NIST. Accessory equipment such as computers, keyboards, display screens, printers/scanners, and working surfaces should be organized and secured. Storage space for station records, equipment manuals, standard operating procedures, consumable supplies, and spare parts must also be made available.

At initial startup all system components shall be powered up and allowed a sufficient warm-up and shelter temperature equilibration. Most individual instrument manufacturers will state a warm-up period of at least an hour. Better results are achieved by an equilibration period of at least several hours, overnight is optimum.

5.3 Data Documentation & Recordkeeping Procedures

The collection of valid, representative air quality data is dependent on good recordkeeping procedures. These procedures must be in place prior to the commencement of data collection.



A general station log must be kept in which the site operator will record any event, circumstance, or condition that affects or has the potential to affect data quality. Additional records will include:

- weekly site visit & operational checklists;
- shelter maintenance logs for routine cleaning, repairs, and equipment change outs;
- individual system component repair and maintenance logs (i.e. for the monitoring system analyzer, calibrator, and zero air generator); and,
- file records for all equipment certifications and standard traceability.

Notes shall be clear and concise but sufficiently thorough to provide an understandable explanation to a third-party responsible for reviewing, validating, and reporting monitoring results. Relevant information must include:

- date and time in Alaska Standard Time (AST);
- name of the person recording the log entry and, if applicable, the name of other persons involved in on-site activities;
- if appropriate, system component identification of manufacturer (make), model number, serial number and, where applicable, certification date of traceable standards; and
- specific notes relating to the procedure, event, circumstance or condition and the effect on data quality.

In past days, all these records were kept and recorded in logbooks or on paper checklists, which in many cases may still be appropriate. However, modern DAS systems and software packages have a variety of options for keeping these types of records in an electronic format. Precautions shall be taken to provide secure data backup in a format that (as much as possible) protects against data loss and record alteration.

5.4 Operator Training

It is essential to the success of any air monitoring program that all personnel involved with on-site operations be qualified and thoroughly trained in all aspects of system components and support equipment operation **and** have a thorough understanding of the data validation process, the QAPP and this SOP manual.

IMPORTANT NOTE: Do not underestimate the significant time investment required on the part of the site operator(s) and a senior level instructor to achieve an adequate level of competence.

6. OPERATIONAL PROCEDURES

6.1 Calibration Procedures for the NO/NO_x/NO₂ Analyzer

The calibration performed on a continuous NO/NO_x/NO₂ analyzer shall consist of a multi-point calibration, in which the analyzer is challenged with ultra-pure zero air and at least four up-



DEC Air Monitoring & Quality Assurance Program
SOP –NO/NO_x/NO₂ Monitoring by Chemiluminescence

Revision 2, June 2016

scale points of known reference gas concentration to assess the analyzer response over the selected measurement range. An initial adjusted multi-point calibration ensures the instrument is performing accurately and establishes a beginning benchmark or bracket that documents the instrument has been successfully adjusted and meets QC performance criteria. Calibration of the NO/NO_x/NO₂ analyzer must be performed “in situ” (in place) at the permanent monitoring site. Calibrations should be performed with the reference gas introduced directly to the back of the instrument as to negate any systematic bias that may be introduced from the sample flow system.

Because the analyzer measures three parameters NO/NO_x/NO₂, a multi-point calibration is more intricate than a single gas analyzer. It begins generating multiple concentrations of NO to challenge the NO/NO_x measurement channels followed by generating multiple concentrations of NO₂.

Calibration may be accomplished by either of the following two methods:

- a calibration using a dynamic dilution multi-gas calibrator to blend ultra-pure zero air with a certified reference gas cylinder of NO to generate multiple NO/NO_x concentrations, but also equipped with a precision ozonator to perform a gas phase titration (GPT) reacting NO + O₃ to generate multiple concentrations of NO₂; or
- a calibration using a dynamic dilution calibration system to precisely blend ultra-pure zero air with a certified NO reference gas to generate multiple NO/NO_x concentrations combined with a certified permeation device to generate multiple concentrations of NO₂.

IMPORTANT NOTE: NO₂ is a reactive gas and not suitable for long-term storage in high pressure cylinders at concentrations less than 1 ppm. Therefore using individual cylinders at low level (ppb) concentrations is not practical for multi-point calibrations. This chemical characteristic necessitates use of a gas blending system with GPT or a gas blending system with NO₂ permeation device.

The procedural principle is same for either of the above calibration options. The only different is how the test atmospheres are blended and generated for delivered to the analyzer. The first option is the most common method used and is described below.

[6.1.1 Calibration procedures using a dynamic dilution calibration system with a GPT](#)

1. Access copies of the NO/NO_x/NO₂ calibration data sheets or the MS Excel workbook. An example is shown in **Figures 3 and 4**. Before proceeding, record all relevant data for dates, technician names, instrument model numbers, serial numbers, etc. Record the analyzer “As Found” calibration coefficients. Assure that the zero air supply, dynamic calibration system, and certified reference gas cylinder are properly connected and operating pressures set in accordance with the manufacturer’s operating manual. Attach



calibration tubing directly from the back of the calibration system output manifold to the sample port on the rear of the analyzer.

IMPORTANT NOTE: During any calibration procedure care shall be taken to not over pressurize the analyzer sample flow system. Excess flow generated from the calibration system must be vented to an atmospheric dump and exhausted outside the monitoring shelter.

6.1.2 Adjustment of Background

2. Initiate the flow of zero air. Allow sufficient time for the analyzer to respond and the output signal to stabilize. In accordance with the instrument operating manual adjust the analyzer controls until the output response for the pre-reactor channel and the NO/NO_x/NO₂ channels are set to 0 ppb. The analyzer visual display value and the DAS should be identical within 0.1 ppb. If not make appropriate electronic adjustments in accordance with the instrument operating manual.

6.1.3 Adjustment of the NO Channel

3. Adjust the calibration system to produce a NO calibration gas at a concentration of approximately 80 percent of the upper range limit (URL) of the instrument. Calculation of NO concentration at the calibrator output manifold ([NO]OUT) is shown in **Equation 2**. Most micro-processor based calibrators will automatically calculate this concentration value.

Equation 2 Calculation of [NO]_{OUT}

$$[NO]_{OUT} = \frac{F_{NO} \times [NO]_{STD}}{F_{NO} + F_O + F_D}$$

Where:

[NO]_{OUT} = NO concentration at the calibrator output manifold (ppm)

[NO]_{STD} = concentration of the NO certified cylinder gas standard (ppm)

F_{NO} = flow rate of NO standard gas (cm³/min)

F_O = flow rate of ozone (cm³/min)

F_D = flow rate of diluent zero air (cm³/min)

Important Note: The calculation above is in units of parts per million (ppm). If the instrument measurement scale is in parts per billion, use the conversion shown in **Equation 3**.

Equation 3 Conversion of ppm to ppb

$$ppb = ppm \times 1000$$



DEC Air Monitoring & Quality Assurance Program

SOP –NO/NO_x/NO₂ Monitoring by Chemiluminescence

Revision 2, June 2016

Figure 3 NO/NO_x/NO₂ Calibration Data Sheet (Page 1 of 2)

NO/NO _x /NO ₂ "Trace Level" Calibration Data Sheet													
Site Location:	Fairbanks Ncore	Date of Calibration:	6/1/2016	Page: 1 of 2									
Technician Name:	Bob Morgan	Calibration Start Time:	9:00	Calibration End Time: 10:30									
Calibration Reference Information													
NO/NO _x /NO ₂ Analyzer Data				Calibration Factors				Reference Gas Data					
Analyzer Make/Model:	ThermoFisher Env. Inst. 42i-TL	Calibration Coefficients		"As Found"	"As Left"	Certified NO Gas Conc. ppm		25.00					
Analyzer Serial No.:	1405262738	NO Background Coef:		0.0	0.0	Certified NO ₂ Impurity Conc. ppm		0.13					
Upper Range Limit ppb:	300	NO _x Background Coef:		0.0	0.0	Vendor/Cylinder Serial No.:		Scott Marrin CC123456					
Internal Temp °C:	28.6	Prereactor Background Coef:		0.0	0.0	Cert. Expiration Date:		4/27/2019					
Cooler Temp °C:	-9.8	NO Coef:		1.000	1.004	Multi-Gas Calibrator Data							
Converter Temp °C:	320.7	NO ₂ Coef:		1.000	1.003	Calibrator Make/Model:		Enviroconics 9100					
Pressure mm Hg:	232.5	NO _x Coef:		1.000	1.005	Calibrator Serial No.:		4628					
Sample Flow LPM:	0.573	Calibration Pressure mmHg:		150.0	150.0	Last Flow Calibration:		3/23/2016					
Ozonator Flow LPM:	0.05	Zero Air Generator Data											
PMT Voltage VDC:	-750	ZAG Make/Model:		Teledyne API 701									
		ZAG Serial No.:		7754									
		Last Service Date:		3/21/2016									
NO/NO _x Multi-Point Linearity Checks by Dynamic Gas Dilution													
Calibration Point	Target Conc. Ppb	Pollutant Flow sccm	Total Flow (Pol+O ₃ +Dil) sccm	Calculated [NO _x]out Conc. ppb	Calculated [NO]out Conc. ppb	NO _x DAS Response ppb	NO DAS Response ppb	NO ₂ DAS Response ppb	Calculated NO _x Best Fit Concentration y=mx+b ppb	Calculated NO Best Fit Concentration y=mx+b ppb	NO _x di Percent Difference %	NO di Percent Difference %	
1	Zero Air	na	5000.0	0.0	0.0	0.1	0.1	0.0	0.1	0.0	na	na	
2	60	12.0	5000.0	60.3	60.0	60.2	60.0	0.2	60.5	60.1	-0.4%	-0.2%	
3	120	24.0	5000.0	120.6	120.0	120.4	120.2	0.2	120.9	120.5	-0.4%	-0.2%	
4	180	36.0	5000.0	180.9	180.0	180.8	180.4	0.4	181.6	180.9	-0.5%	-0.3%	
5	240	48.0	5000.0	241.2	240.0	241.2	240.8	0.4	242.3	241.5	-0.5%	-0.3%	
NO _x Linear Regression		m= 1.0047		b= -0.02		r ² = 1.00000		% Diff. QC Criteria ≤ ±2%					
NO Linear Regression		m= 1.0030		b= -0.06		r ² = 1.00000							
Linearity QC Criteria m = 1.00 ± 0.05													
NO _x CALIBRATION CURVE							NO CALIBRATION CURVE						



DEC Air Monitoring & Quality Assurance Program

SOP –NO/NO_x/NO₂ Monitoring by Chemiluminescence

Revision 2, June 2016

Figure 4 NO/NO_x/NO₂ Calibration Data Sheet (Page 2 of 2)

NO/NO _x /NO ₂ "Trace Level" Calibration Data Sheet													
Site Location: Fairbanks NCORE			Date of Calibration: 6/1/2016			Page: 2 of 2							
Technician Name: Bob Morgan			Calibration Start Time: 10:30			Calibration End Time: 11:45							
NO ₂ Multi-Point Linearity Checks by Dynamic Gas Dilution with Gas Phase Titration (GPT)													
Calibration Point	Target NO ₂ Conc. ppb	Pollutant Flow sccm	Total Flow (Pol+O ₃ +Dil) sccm	Calculated [NO _x]out ppb	[NO _x] DAS Response ppb	[NO] DAS Response ppb	Calculated [NO ₂]out ppb	NO ₂ DAS Response ppb	Calculated NO ₂ Best Fit Concentration y=mx+b ppb	Calculated [NO ₂]conv ppb	NO ₂ di Percent Difference %		
Zero Air	0	na	5000	na	na	na	na	na	na	na	na		
Original w/o GPT	na	53.72	5000	270.0	269.9	269.8	0.1	0.1	-0.1	na	na		
NO ₂ GPT 1	60	53.72	5000	270.0	269.1	210.0	59.1	59.1	59.0	58.3	0.1%		
NO ₂ GPT 2	120	53.72	5000	270.0	269.3	149.8	119.5	118.9	119.0	118.9	0.0%		
NO ₂ GPT 3	180	53.72	5000	270.0	269.5	90.6	178.9	179.3	179.5	178.5	-0.1%		
NO ₂ GPT 4	240	53.72	5000	270.0	269.8	30.9	238.9	239.4	239.7	238.8	-0.1%		
				Linear Regression NO ₂		m =		1.0023		b = -0.2		r ² = 1.0000	
				Linearity QC Criteria m = 1.00 ± 0.05				di (% Difference) QC criteria at each point ± 2 %					
				NO _x Converter % Efficiency = 100.4				NO _x Converter Efficiency QC criteria > 96%					

NO₂ CALIBRATION CURVE

Y-axis: NO₂ Response y=mx+b (0.0 to 250.0)

X-axis: Calculated NO₂out (0.0 to 250.0)

NO₂ CONVERTED

Y-axis: Calculated NO₂ Converted (0.0 to 250.0)

X-axis: Calculated NO₂out (0.0 to 250.0)



4. Allow sufficient time for the analyzer to respond and the output signal to stabilize. In accordance with the instrument operating manual adjust the analyzer NO channel output to match the [NO]_{OUT} reference gas concentration. The analyzer visual display value and the DAS should be the same. If not make appropriate electronic adjustments in accordance with the instrument operating manual. Record the analyzer response from the DAS.

IMPORTANT NOTE: *If significant adjustments to the instrument electronics were needed to set the zero and upscale 80 percent calibration concentration, the operator may want to repeat steps 1 – 4 to fine tune the analyzer response.*

6.1.4 Adjustment of the NO_x Channel

5. Without further adjustment to the calibration system, calculate the NO_x reference gas concentration, [NO_x]_{OUT}. This calculation is the same as **Equation 2** with the exception that it adds in the quantitative impurity of NO₂ in the NO certified cylinder gas standard. The concentration of any impurity will be documented in the cylinder vendor's Certificate of Analysis. This calculation is presented in **Equation 4**.

Equation 4 Calculation of [NO_x]_{OUT}

$$[NO_x]_{OUT} = \frac{F_{NO} \times ([NO]_{STD} + [NO_2]_{IMP})}{F_{NO} + F_O + F_D}$$

Where:

[NO_x]_{OUT} = NO_x concentration at the calibrator output manifold (ppm)

[NO]_{STD} = concentration of the NO certified cylinder gas standard (ppm)

[NO₂]_{IMP} = concentration of NO₂ impurity in the certified cylinder gas standard (ppm)

F_{NO} = flow rate of NO standard gas (cm³/min)

F_O = flow rate of ozone (cm³/min)

F_D = flow rate of diluent zero air (cm³/min)

6. Allow sufficient time for the analyzer to respond and the output signal to stabilize. In accordance with the instrument operating manual adjust the analyzer NO_x channel output to match the [NO_x]_{OUT} reference gas concentration. The analyzer visual display value and the DAS should be the same. If not make appropriate electronic adjustments in accordance with the instrument operating manual.
7. If significant electronic adjustments were necessary for the instrument responses to match NO and NO_x reference gas values, it may be reasonable for the operator to go back and recheck the instrument background responses to zero air as discussed in Step 1. If any adjustments are necessary, the operator should repeat steps, 2 through 6.



DEC Air Monitoring & Quality Assurance Program
SOP –NO/NO_x/NO₂ Monitoring by Chemiluminescence

Revision 2, June 2016

8. Once the instrument responses are finalized, record in the station log the instrument NO/NO_x values for zero background and calibration coefficients. These values will be available for the instrument's visual display menu. Documentation of these values will serve as a benchmark to indicate any future adjustments to the analyzer calibration.

6.1.5 Confirmation of Instrument Linearity for NO/NO_x Channels

9. The next step is to verify the instrument linearity. **Without further adjustment**, recheck the analyzer response to zero air. Allow a sufficient time for the analyzer response to stabilize.

IMPORTANT NOTE: *The time period for the analyzer to respond and provide a stable output concentration value will vary depending on the analyzer's response characteristics. As a matter of good practice, DEC recommends a minimum period of **at least 15 minutes**. This will allow about 10 minutes for the analyzer to respond and stabilize, then record the next five (or more) 1-minute values to calculate an average response for the zero air or up-scale concentrations.*

10. Record the average responses for the NO/NO_x/NO₂ channels from the DAS. In accordance with the NO/NO_x/NO₂ data validation template as presented in Appendix A, the analyzer response to ultra-pure zero air for the three channels should be ≤ 1.5 ppb.
11. Reset the calibration system to again to recheck the analyzer response to a reference gas at a concentration of approximately 80 percent of the upper range limit (URL) of the instrument and record and calculate the average response from the DAS for both the NO/NO_x/NO₂ channels. The NO and NO_x channels should be nearly identical except for the minor different in the NO_x value resulting from the NO₂ impurity, which is usually 1 to 2 ppb.
12. In successive steps, check the analyzer response to at least three more reference gas concentrations evenly spaced over the selected operating range of the instrument or (as discussed in Section 4.2) within an appropriate range of concentrations expected to be observed. Additional concentrations may be included if deemed necessary. Record and calculate the average analyzer response from the DAS for each reference concentration points for both NO and NO_x channels.
13. With the data collected for the zero air and 4 up-scale points, plot and perform a linear regression analysis for both the NO/NO_x data sets comparing the analyzer responses (y-axis) to the reference gas concentrations (x-axis). The regression analyses will yield a best-fit line for each data set. The resulting equations will be in the form of **Equation 5**.



Equation 5 Least squares regression equation for calculation of best-fit calibration line

$$y = mx + b$$

Where:

y = the analyzer response for the specific point

m = the slope of the best-fit line

x = the concentration of NO/NO_x at the calibrator output manifold, ppm

b = the y-axis intercept of the best fit line

14. The regression analyses will provide a slope (m) and a y-axis intercept (b) for each of the NO/NO_x best-fit line expressions.
15. Using the slope and intercept values derived from the NO linear regression analysis in **Equation 5**, calculate the NO “Best Fit Concentration” for each of the four upscale points and record the results.
16. Using the slope and intercept values derived from the NO_x linear regression analysis in **Equation 5**, calculate the NO_x the “Best Fit Concentration” for each of the four upscale points and record the results.
17. Comparing the NO_x DAS response to the NO_x best fit concentration calculate and record the percentage difference using **Equation 6** for each point.
18. Perform the same calculation for the NO points.

Equation 6 Calculation of percentage difference (di)

$$d_i = \left[\frac{\text{Average DAS Response} - \text{Best Fit Concentration}}{\text{Best Fit Concentration}} \right] * 100$$

Where;

d_i = percentage difference

19. The QC operational criteria for Verification/Calibration as shown in the NO/NO_x/NO₂ Data Validation Template in **Appendix A** requires that the percent difference (*d_i*) for each point be within ± 2 percent. If this QC criteria is not met for any of the four upscale points, corrective action must be taken to resolve the issue and the calibration repeated.

6.1.6 Adjustment of the NO₂ Channel

Once the analyzer has passed the QC criteria for the NO/NO_x calibrations, the next step is to calibrate the NO₂ channel using GPT. Four upscale concentrations of NO₂ are generated from the calibration system by reacting NO with O₃. The calibration begins by blending a high level concentration of NO. Once the analyzer NO response has stabilized and an average recorded, the calibrator ozonator is actuated to generate four successive upscale concentrations of O₃ to titrate with the original NO concentration. The NO₂ calibration concentration [NO₂]_{out} for each successive point is calculated by the how the NO concentration drops as shown in **Equation 7**.



20. Adjust the calibration system to produce NO/NO_x calibration gas concentrations at approximately 90 percent of the URL of the instrument. Calculation of the NO concentration at the calibrator output manifold ([NO]_{OUT}) is shown in **Equation 2**. Calculation of the NO_x concentration at the calibrator output manifold ([NO_x]_{OUT}) is shown in **Equation 4**.
21. Allow sufficient time for the analyzer to respond and the output signal to stabilize. Record the analyzer responses for the NO/NO_x channels from the DAS. The analyzer response to this NO concentration will be the [NO]_{ORIG} concentration used in **Equation 7** to determine subsequent NO₂ concentration as varying concentrations of O₃ gas are added during the GPT procedure. The analyzer response to this NO_x concentration will be used as [NO_x]_{ORIG} as shown in **Equation 8** to determine the NO₂ converted.

Equation 7 Calculation of [NO₂]_{OUT}

$$[NO_2]_{OUT} = ([NO]_{ORIG} - [NO]_{REM}) + \left(\frac{F_{NO} \times [NO_2]_{IMP}}{F_{NO} + F_O + F_D} \right)$$

Where:

{NO₂]_{OUT} = the titrated concentration of NO₂ at the calibrator output manifold, ppb

[NO]_{ORIG} = the original NO concentration prior to the addition of O₃, ppb

[NO]_{REM} = the NO concentration remaining after the titration with O₃, ppb

[NO₂]_{imp} = the NO₂ impurity from the reference gas certificate of analysis, ppb

F_{NO} = the flow of NO, cm³/min

F_O = the flow of O₃, cm³/min

F_D = the flow of diluent zero air, cm³/min

22. Initiate the GPT calibration by turning on the calibrator O₃ generator and make adjustments to produce sufficient O₃ to decrease the NO concentration to approximately 80 percent of the URL of the NO₂ channel. Allow sufficient time for the analyzer to stabilize.
23. Calculate the [NO₂]_{out} concentration using **Equation 7**. In accordance with the instrument instruction manual adjust the NO₂ channel output to the calculated [NO₂]_{out} concentration. The analyzer visual display value and the DAS value should be identical. If not make appropriate electronic adjustments in accordance with the instrument instruction manual.
24. Record the analyzer responses for all three channels NO/NO_x/NO₂ and document the new NO₂ calibration coefficient from the analyzer display.

6.1.7 Confirmation of Instrument Linearity for NO₂ Channel

25. **Without any further adjustment** to the analyzer, adjust the calibrator O₃ generator to produce sufficient O₃ for at least three more NO₂ calibration points. Calculate the [NO₂]_{OUT} concentrations using *Equation 8* for each point and record the instrument responses for NO/NO_x/NO₂ at each points.



DEC Air Monitoring & Quality Assurance Program
SOP –NO/NO_x/NO₂ Monitoring by Chemiluminescence

Revision 2, June 2016

26. With the data collected for the zero (the NO₂ response to the original NO point prior to GPT) and 4 up-scale points, plot and perform a linear regression analysis for the NO₂ channel comparing the analyzer responses (y-axis) to the [NO₂]_{OUT} gas concentrations (x-axis) to generate a best-fit calibration line. The resulting equation will be in the form of **Equation 5**.
27. The regression analysis will provide a slope (m) and a y-axis intercept (b) for the best-fit line expression.
28. Using the slope and intercept values derived from the NO₂ linear regression analysis in **Equation 5**, calculate the NO₂ “Best Fit Concentration” for each of the four upscale points and record the results.
29. Comparing the NO₂ DAS response to the NO₂ best fit concentration calculate and record the percentage difference using **Equation 6** for each point.
30. The QC operational criteria for Verification/Calibration as shown in the NO/NO_x/NO₂ Data Validation Template in **Appendix A** requires that the percent difference (*d_i*) for each point be within ± 2 percent. If this QC criteria is not met for any of the four upscale points, corrective action must be taken to resolve the issue and the calibration repeated.

6.1.8 Calculation of the NO₂ Converter Efficiency

31. Accurate measurements of NO_x chemical compounds are dependent on the continuous performance of the sample system converter. Critical QC criteria from the NO/NO_x/NO₂ validation template as shown in Appendix A requires a converter efficiency within the range of 96 to 104 percent. The converter efficiency is calculated from the data collected in the NO₂ GPT calibration. The converter performance is checked at each calibration point as the O₃ level and the subsequent [NO₂]_{OUT} concentration increases. If the converter is operating efficiently, the NO_x concentration should remain approximately the same at each point. The calculation is shown in **Equation 8**.

Equation 8 Calculation of the NO₂ converter efficiency

$$[NO_2]_{CONV} = [NO_2]_{OUT} - ([NO_x]_{ORIG} - [NO_x]_{REM})$$

Where:

[NO₂]_{CONV} = concentration of NO₂ converted, ppb

[NO₂]_{OUT} = the diluted NO₂ concentration at the output manifold, ppb

[NO_x]_{ORIG} = the original NO_x concentration prior to the titration with O₃, ppb

[NO_x]_{REM} = the NO_x concentration remaining after the titration with O₃, ppb

32. Perform this calculation for each of the GPT calibration points.
33. Perform a linear regression of the results. The x-axis being [NO₂]_{OUT} versus the y-axis being [NO₂]_{CONV}. The slope of the calibration line time 100 will equal the converter efficiency as a percentage.



34. If the converter efficiency is outside the Operational QC limits, corrective action must be taken to rejuvenate or replace the converter, followed by another calibration.

All calibration equations were derived from the EPA procedures at prescribed in 40 CFR 50, Appendix D⁸ and as revised in the *Guideline on the meaning and the use of precision and bias data required by 40 CFR Part 58*, specifically equations from the EPA Data Assessment Statistical Calculator.⁹

6.2 Routine Operational Checks

Routinely scheduled operational checks are essential for evaluating and documenting the ongoing quality of the data. These QC checks range from physical inspections of the shelter and sample system to status checks of the various instruments and auxiliary equipment components. **Figure 5** presents an example spreadsheet for the operational checks. It is recommended that these status checks be documented during every site visit or at least weekly. The form may be completed digitally via MS Excel or on a paper copy with files appropriately archived for the data record.

6.2.1 Shelter Temperature

Maintaining a stable shelter temperature is a factor in preventing calibration drift in monitoring instrumentation and is listed as an operational QC criteria listed in the NO/NO_x/NO₂ Data Validation Template shown in **Appendix A**. The monitoring shelter or the room housing the analyzer must contain a sensor to continuously record room temperature to $\pm 1^\circ$ C. Note the following items: current temperature; daily maximum temperature, daily minimum temperature, and the daily variation in room temperature as standard deviation over the daily 24-hour period. If the daily criteria are exceeded make a note in the station log to flag data with a QC operational deviation. Take appropriate corrective action to stabilize room temperature.

6.2.2 Sample System Inspection

The sample system inspection is performed to assess and prevent any bias to the measurements resulting from foreign materials, moisture, or damage. The sample system consists of:

- a. sample inlet;
- b. (if applicable) a sampling manifold with moisture trap and blower motor;
- c. all gas connections and solenoid valves associated with the calibration system;
- d. all sample tubing within the sample flow system to the analyzer; and
- e. exhaust manifold.

⁸ 40 CFR 50, Appendix F, Measurement of Principle and Calibration Procedures for the Measurement of Nitrogen Dioxide in the Atmosphere (Gas Phase Chemiluminescence).

⁹ EPA *Guideline on the meaning and the use of precision and bias data required by 40 CFR Part 58*, EPA-454/B-07-001, January 2007. Data Assessment Statistical Calculator <https://www3.epa.gov/ttn/amtic/qareport.html>



DEC Air Monitoring & Quality Assurance Program
SOP –NO/NO_x/NO₂ Monitoring by Chemiluminescence

Revision 2, June 2016

Figure 5 NO/NO_x/NO₂ Monitoring Program Operational Checklist

NO/NO _x /NO ₂ Monitoring Program - Operational Data Record							
Operational Item	Acceptable Operating Limits or Description	Date	Date	Date	Date	Date	Date
Site Operator or Technician	Initials						
Date	yyyy/mm/dd						
Time of Checks (AST)	hh:mm						
Shelter or Room Temperatures							
Current Temperature °C	(15 to 30 °C)						
Max Temperature °C in last 24 hrs	≤ 30 °C						
Min Temperature °C in last 24 hrs	≥ 15 °C						
Variability in last 24 hrs	SD ≤ 2° C						
Electrical Surge Protection or UPS	Yes or No						
Sample System Inspection							
Sample Inlet open & debris free	Yes or No						
Sample manifold open & debris free	Yes or No						
Sample tubing open & debris free	Yes or No						
Any indication of moisture	Yes or No						
Exhaust tubing open & debris free	Yes or No						
Exhaust exterior open & debris free	Yes or No						
Calibration Gas Cylinder Inspection							
Is Cylinder safely secured to wall?	Yes or No						
Certified NO Concentration	ppm						
Gas Cylinder Serial No.	#####						
Cylinder Valve and Line Valve	Open						
Tank Pressure psig	200-2000 psig						
Line Pressure psig	25 ± 2 psig						
Zero Air Generator							
Power On	On						
Output Pressure psig	20 to 25 psig						
Pressure Tank Moisture Drain	Operational Yes or No						
Date of Last Reagent Change & Maintenance	yyyy/mm/dd						
MultiGas Calibrator							
Power On	On						
Program Mode	Flow/Conc/Auto						
Display Date & Time (AST, 24-hr clock)	yyyy/mm/dd hh:mm						
Date of Last Flow Calibration	yyyy/mm/dd						
NO/NO _x /NO ₂ Analyzer							
Power On, Display up, in Sample Mode, & Operating	On with Run Display illuminated (V)						
Current NO/NO _x /NO ₂ Concentration	##/##/## ppb						
Comparison of Analyzer to DAS ppb	± 0.5 ppb Yes or No						
Current Time (AST, 24-hr clock)	hh:mm						
Alarm Status (Is the Alarm Icon active?)	Yes or No						
(If in alarm status)	Identify Alarm						
Date of Monthly Particulate Filter Changeout	yyyy/mo/dd						
On-Site Data Acquisition System (DAS) & Communications							
Data Logger Power On	Power Switch On (in the up position)(V)						
Display Up and Software Functional	Yes or No						
Date and Time (±1 min NIST AK Std Time)	Yes or No						
DAS/Analyzer Communicating	Yes or No						
Modem/Router Power (On & Functional)	Yes or No						
External Communication (Internet Access)	Yes or No						

If any irregularities are noted in the above readings, provide a full explanation and any corrective actions take in the station logbook.



The site operator should conduct a visual inspection of the above components during each site visit. Inspection items should include:

- a. breakage, crimps, constriction of flow or discoloration in any of the tubing;
- b. moisture, particulates or foreign matter deposition inside the sample manifold or tubing;
- c. tight, secure connections to prevent leaks; and
- d. exhaust manifold flow is unrestricted to the exterior of the shelter.

Any irregularities noted from the above inspections will require immediate corrective action and documented in the station log.

6.2.3 Gas Cylinder Inspection

The cylinder gas inspection is to assure the cylinder is safe, appropriately certified and properly delivered to the dynamic gas dilution calibration system. The operational items include:

- the cylinder is safely secured to the wall or other unmovable structure;
- the certified gas concentration;
- the gas vendor's cylinder serial number;
- the gas cylinder valve and line valve are open and functional;
- the tank pressure is within 200 to 2000 psig; and
- the line pressure from the stainless-steel 2-stage pressure regulator is properly set the calibrator specifications.

6.2.4 Zero Air Generator Checks

The zero air generator must be checked to insure the unit is on, the display indicates functionality, the output pressure is within acceptable limits and the moisture drain is operating and not blocked. The last change of scrubber media must be recorded and assessed for scheduled replacement.

6.2.5 Multi-gas Calibrator Checks

The on-site multi-gas calibrator blends known concentrations of reference gas and ultra-pure zero air to perform routine QC calibrations and performance verifications on the NO/NO_x/NO₂ analyzer. The microprocessor-based calibrator consists of at least two mass flow controllers, solenoid valves, a mixer chamber, sensors for pressure and temperature to correct the volumetric flow rates to standard conditions. (The calibrator may include a third mass flow controller to perform serial dilutions to blend trace-level gas concentrations.) EPA operational QC criteria requires the calibrator mass flow controllers and auxiliary systems to be calibrated semi-annually. Note and record the following operational items:

- power is on, display up, and ready for operation;
- program mode (concentration, flow, or auto);



- display date and time within ± 1 of AST; and
- date of last mass flow controller calibrations.

6.2.6 Analyzer Status Checks

Status checks performed on the NO/NO_x/NO₂ analyzer will vary among instrument manufacturers but in general they will include:

- power on, the display up, in sample mode, and operating;
- record the current NO/NO_x/NO₂ concentration in ppb;
- compare the analyzer display concentration to the DAS display concentration (within ± 0.5 ppb);
- record current date and time (± 1 minute of AST);
- if the current display concentration matches the DAS concentration within;
- date of the last multi-point calibration or verification;
- note and identify any alarm conditions; and,
- date of the last sample filter change.

The site operator must conduct a visual inspection of the sample system particulate filter on a regular basis to assess local dust conditions and determine the frequency of necessary filter changes. Any particulate matter accumulation that discolors of the filter material shall prompt a replacement. At a minimum, the particulate filter should be replaced on a monthly basis. A system leak check is to be performed following each change.

6.2.7 Data Acquisition System (DAS) Checks

Whether the DAS is a standard alone data logger or a computer/server record the manufacturer, model number, and serial number along with the current software and version. Note the following items:

- the power is on;
- the display is up and software is operational;
- the current date and time is correct and synonymous (within ± 1 minute) with AST;
- the DAS is communicating with analyzer showing all the configured monitoring channels with instantaneous readings;
- the modem and/or router is powered and functional; and
- confirm external communication with accessibility to the Internet.

6.3 Routine QC Performance Verification Checks

Upon completion of installation, startup and initial calibration, the monitoring system will generate and store 1-minute data values representing the ambient air concentrations of NO/NO_x/NO₂. From this starting point, routine procedures must be performed to assure the on-going quality of the data. The primary quality control (QC) procedures used to verify analyzer



performance and data quality are referred to as Zero/Span Checks. These checks assess data accuracy at the low and high ends of the analyzer measurement range. Another QC check is performed to verify data accuracy near the range of NO/NO_x/NO₂ concentrations normally measured in ambient air. In the EPA QA Handbook, Volume II, this procedure is referred to as a “One Point QC Check, Single Analyzer,” more frequently referred to as a “precision check.”

6.3.1 Zero/Span Checks

Zero/span checks are to assess data quality and on-going analyzer performance, and are also performed for system diagnostics. This is done by challenging the NO/NO_x/NO₂ analyzer first with zero air and then with an up-scale NO/NO_x/NO₂ concentration typically set at 80 percent of the measurement range. These checks may be performed manually or through an automated program function of the analyzer, calibration system and the DAS. Like the calibration procedures, the zero/span checks are performed first for NO/NO_x, and then GPT is used to titrate a concentration for the NO₂ span check.

Important Note: Zero air and reference gases generated for these checks are introduced to the sample system near the sample probe inlet. In addition to analyzer performance, this allows for an assessment of system bias resulting from the exposure of the calibration gases to the sample system. The required minimum frequency to perform zero/span and precision checks as shown in **Appendix A** is once every two weeks; however, DEC “**highly**” recommends that zero/span and precision check be performed more frequently.

1. The zero check begins with the calibration system generating zero air through the multi-gas calibrator. Manual or solenoid valves are actuated to feed the zero air into the sample system for a period of time until the analyzer response stabilizes. The stabilization period of time will depend on the manufacturer’s specification for instrument response. Once stabilized, a five minute average is typically calculated to determine the analyzer NO/NO_x/NO₂ DAS response for zero air.
2. The results of the zero air checks are not calculated as percent difference but rather as zero drift simply by subtracting the analyzer response from zero as shown below in **Equation 9**.

Equation 9 Calculation of zero drift

$$\text{Zero Drift} = 0.0 - \text{analyzer DAS response to ultra-pure zero air}$$

Where:

Zero Drift (ppb)

Analyzer Response in ppb as recorded from the DAS (ppb)

Zero Air (ppb)

3. Upon completion of the zero air check, the span check is initiated by actuating the multi-gas calibrator (either manually or automatically) to generate an NO/NO_x gas concentration at 80 percent of the analyzer URL. The blended span gas concentrations for [NO]_{out} and [NO_x]_{out} are calculated using **Equations 2 and 4**. The check is allowed to proceed for a specified period allowing the analyzer response to stabilize. A five



minute average for the analyzer DAS response to span gas is then calculated and recorded.

4. For each of the NO and NO_x span checks calculate a percent difference using **Equation 6**.
5. The NO₂ span is initiated by generating a NO/NO_x original concentration at 90 percent of the analyzer URL. Allow the analyzer to stabilize. Calculate an average analyzer response and record.
6. Initiate the calibrator GPT function to titrate an NO₂ span concentration at about 80 percent of the analyzer URL. The [NO₂]_{out} concentration is calculated using **Equation 7**.
7. Allow the analyzer response to stabilize, calculate a 5-minute average response and a percent difference using **Equation 6**.

6.3.2 Precision Checks

This one-point QC check is performed to assess data accuracy and repeatability within a measurement range more typical of NO/NO_x/NO₂ concentration that would be measured in ambient air. The EPA requires that this QC check be performed within a concentration range of 0.010 ppm to 0.100 ppm. The EPA also requires that this one-point QC check be performed at least once every two weeks. (*DEC “**highly**” recommends that precision checks be performed more frequently.*)

1. Precision checks are typically performed following zero/span checks. Upon completion of the zero/span checks the calibration system is prompted (either manually or by programmed function) to generate a reference gas concentration within the range of 0.010 to 0.100 ppm. Calculation of reference gas concentrations and percent difference are performed as discussed above. For consistency in the required statistical analysis of the precision data, once selected this concentration should remain the same for on-going checks. The check is allowed to proceed for a specified period allowing the analyzer response to stabilize. The analyzer response is then recorded by the DAS.
2. At the final conclusion of the Zero/Span/Precision checks, the calibration system is prompted (either manually or by programmed function) to generate zero air. The purpose of introducing zero air is to purge any residual NO/NO_x/NO₂ from the sample system. For NO/NO_x/NO₂ monitoring, the zero air purge should proceed for a period of at least five minutes before returning to sample status.

6.3.3 Routine Multi-Point Verifications

EPA requires that analyzer performance across the entire measurement range of the instrument be routinely verified. As shown in NO/NO_x/NO₂ Data Validation Table in **Appendix A**, a multi-point verification is to be performed every six months if zero/span and precision check are conducted biweekly. If zero/span and precision checks are conducted continuously on a daily basis, the multi-point verification need only be conducted once per year. As with the initial calibration the multi-point verification would consist of determinations for zero air and four up-scale NO/NO_x/NO₂ concentrations. The difference being is that for a verification, the analyzer response for each concentration is recorded “As Found” without any adjustments made to the



instrument. Typically the concentrations would be established at the following percentages of the URL:

- Zero air
- 80 to 90 percent of the URL
- ~60 percent of the URL
- ~40 percent of the URL
- <20 percent of the URL (usually 18 to 20 percent)

Important Note: *Unlike an initial calibration, the zero air and up-scale gases used during a multi-point verification are introduced to the sample system near to the sample inlet to assess system bias as well as analyzer performance.*

The results of the multi-point verification are to be recorded and statistical analysis completed using the “NO/NO_x/NO₂ Calibration Data Sheet” spreadsheet shown in **Figures 3 and 4**. Calculation of reference gas concentrations, converter efficiency, and percent difference are performed as discussed above in **Equations 2 - 8**.

6.3.5 Performance Verification QC Limits

The NO/NO_x/NO₂ Data Validation Template shown in **Appendix A** present the “Critical Criteria” for a One-Point QC Check, Single Analyzer (the precision point) as ± 10 percent. The same criteria is used for span drift. The “Critical Criteria” for zero drift as presented in the EPA QA Handbook as revised in 2013¹⁰ is ± 1.5 ppb; however, EPA revised these criteria in a memorandum from Lewis Weinstock, Office of Air Quality Planning and Standards (OAQPS) on June 3, 2014.¹¹ The revised zero drift acceptance criteria is now ± 3 ppb over a 24-hour period or ± 5 ppb over a 14-day period. Deviation beyond these critical QC limits is grounds for data invalidation.

The “Operational Criteria” QC acceptance criteria for Multi-point verifications are the same as discussed in section 6.1.

6.4 Corrective Actions

To achieve data quality objectives, the site operator and other monitoring staff must respond whenever equipment status checks deviate from operational norms or performance QC verification results approach or fail acceptance criteria. To avoid data invalidation and to

¹⁰ *Quality Assurance Handbook for Air Pollution Measurement Systems, Volume II, Ambient Air Quality Monitoring Program*, EPA-454/B-13-003, May 2013. <https://www3.epa.gov/ttnamti1/files/ambient/pm25/qa/QA-Handbook-Vol-II.pdf>

¹¹ Memorandum, “Revision to the Zero Drift Acceptance Criteria in the QA Handbook” Lewis Weinstock, Office of Air Quality Planning and Standards, June 3, 2013. <https://www3.epa.gov/ttn/amtic/files/policy/zerodriftmemo6314.pdf>



DEC Air Monitoring & Quality Assurance Program
SOP –NO/NO_x/NO₂ Monitoring by Chemiluminescence

Revision 2, June 2016

optimize data capture, DEC has established specific thresholds when corrective action is warranted. **Table 1** presents the DEC protocol for corrective action thresholds.

If the action thresholds were exceeded, an initial assessment must be made to determine the extent of the corrective action required. For the threshold conditions highlighted in pink indicating exceedance of QC critical criteria, data shall be invalidated or at a minimum flagged with a qualifier code. For the threshold conditions highlighted in yellow indicating the data are still with QC acceptance criteria but requires attention, the corrective action may be less stringent. This may be a matter of performing simple maintenance (e.g. replacing a particulate filter or repairing a leak in the sample system) and may not require an adjustment to the analyzer. For minor zero drift ± 2 ppb, the site operator may adjust the analyzer zero background setting without a calibration. If the calibration drift at the span or precision point exceeds ± 4 percent, further assessment and a recalibration is required.

Following any corrective actions a zero/span/precision check or a full calibration shall be performed to bracket data quality going forward. All corrective actions shall be thoroughly documented in the station logbook and/or the DAS electronic log.

Table 1 Corrective Action Thresholds for the NO/NO_x/NO₂ Analyzer

Zero Drift as percentage difference (d_i) or as absolute difference (ppb)	Description of Corrective Action		Calibration Drift as percentage difference (d_i)
$> + 2\%$ of full scale	Invalidate data and recalibrate		$> +10\%$
$> + 2$ ppb	Zero Drift	Calibration Drift	$> +4\%$
	Assess and adjust zero background if needed	Assess and recalibrate if needed	
± 2 ppb	No corrective action required		0 to 4%
$< - 2$ ppb	Zero Drift	Calibration Drift	$< -4\%$
	Assess and adjust zero background if needed	Assess and recalibrate if needed	
$< - 2\%$ of full scale	Invalidate data and recalibrate		$< - 10\%$



6.5 Preventative Maintenance

Maintenance procedures or activities that prevent equipment failures, costly repairs, and subsequent data losses need to be performed on a routine basis. **Table 2** is an example preventative maintenance schedule. Site specific SOPs should incorporate specific maintenance schedules for individual equipment components base on their service manuals. These activities should be performed in accordance with service manual recommendations or more often if status and performance verifications indicate the need.

Table 2 Example Preventive Maintenance Schedule

Analyzer Preventative Maintenance	
Maintenance Activity	Scheduled Frequency
Inspect the in-line Teflon filter for particulate deposition and discoloration.	Monthly change recommended or more frequently if needed.
Sample system leak check	Monthly with filter change or following any disassembly of the sample system components
Verify analyzer sample flow rate with a certified flow rate standard device, if tolerances exceed manufacturer specifications, inspect and as necessary replace flow capillary and O-rings.	Annually or as indicated by electronic diagnostics
Inspect and clean optical filters and/or condensing lens in the optical bench and O-rings.	As indicated by electronic diagnostics
Inspect and replace the ozonator air drying column.	As indicated by electronic diagnostics
Inspect, clean or replace flow control capillaries	As indicated by electronic diagnostics
Inspect, rebuilt or replace the sample flow pump	As indicated by electronic diagnostics
Inspect, adjust, rejuvenate or replace the NO ₂ converter	As indicated by electronic diagnostics
Inspect and clean the PMT thermoelectric cooler fins	Quarterly or as needed
Inspect, adjust, repair or replace the PMT thermoelectric cooler	As indicated by electronic diagnostics
Inspect and clean the instrument cooling fan and assess function of the fan, adjust or replace as needed.	Monthly or as needed
Assess function of reference and sample flow solenoids, adjust or replace as needed.	As indicated by electronic diagnostics
FEM Detention for instrument noise, performed in accordance with definitions and procedures in 40 CFR 53.26(b)	Typically DEC accepts the manufacturer's specifications for instrument noise.
FEM Detention evaluation for lower detectable level (LDL) performed in accordance with definitions and procedures in 40 CFR 53.26(b)	Typically DEC accepts the manufacturer's specifications for LDL.



Zero Air Generator Preventative Maintenance	
Assess function of the zero air generator by comparing the analyzer response in ppb between the on-site zero air generator and NIST certified ultra-pure zero air cylinder gas. Recommended maintenance if the comparison differential exceeds the lower detectable level (LDL) of the analyzer.	Annually
Assess the function of the zero air generator dryer by testing the output with a certified digital hydrometer. Maintenance recommended if the dew point of the output zero air exceeds manufacturer’s specifications.	Semi-annually
Assess the function of the zero air compressor pump. Rebuild or replace if recommended pressure test exceeds manufacturers specifications.	Annually
Replace scrubber reagents	Annually or as indicated by diagnostics.
Dynamic Dilution Multi-Gas Calibrator Maintenance	
Verify mass flow controller with a certified flow rate standard device, repair and recalibrate if tolerances exceed manufacturers specification	Annually or as indicated by diagnostics
Following annual flow rate verification, inspect flow components O-rings, tubing connectors, and mixing chamber for condition issues. Repair or replace as necessary.	Annually or as indicated by diagnostics
Inspect, adjust, or replace the GPT ozonator UV lamp	As indicated by electronic diagnostics
System leak check	Annually or following any disassembly of system components or as indicated by diagnostics.
Inspect and clean the instrument cooling fan and assess function of the fan, clean or replace as needed.	Monthly or as needed

7. QUALITY ASSURANCE

7.1 Qualification, Verification and Re-verification

All transfer standards used to assure traceability to EPA or NIST standard reference materials or devices shall be certified, verified, and re-verified in accordance with the *EPA Quality Assurance Handbook for Air Pollution Measurement Systems, Volume II, Ambient Air Quality Monitoring Program*, EPA-454/B-13-003, May 2013.

7.2 Data Quality Indicators

Data Quality Indicators are qualitative and quantitative methods used to determine if the Data Quality Objectives of the DEC air program are being satisfied. It is the responsibility of the station operator to take corrective action if the Measurement Quality Objectives are not being



met. Quantitative data quality indicators are results from the zero/span/precision QC checks. If QC results are outside of the “Critical Criteria” presented in **Appendix A** NO/NO_x/NO₂ Data Validation Template, immediate corrective action shall be taken. Qualitative data indicators are analyzer status and function checks that indicate analyzer function is outside the “Operational & Systematic Criteria presented in **Appendix A**. This will also require immediate attention to further assess the condition and take corrective action, if warranted.

7.3 Performance Audits

Quality Assurance performance audits shall be conducted utilizing the procedures and calculations specified in 40 CFR 58, Appendix A, "Quality Assurance Requirements for SLAMS, SPM and PSD Monitoring." The audit shall challenge the NO/NO_x/NO₂ monitoring system with a zero air concentration and at least three upscale NO/NO_x/NO₂ concentrations. The NO/NO_x/NO₂ audit concentrations shall selected in accordance with the USEPA Memorandum of November 10, 2010, *Use of Expanded List of Audit Levels for Annual Performance Evaluation for SO₂, NO₂, O₃, and CO as described in 40 CFR 58, Appendix A, Section 3.2.2*. The NO/NO_x/NO₂ Data Validation Template shown in **Appendix A** requires that QA performance audits be conducted at least once per year. If the results of the QA performance audit are outside the “Critical Criteria” presented in **Appendix A**, corrective action shall be taken. Example audit results for NO, NO_x, NO₂, and NO₂ converter efficiency are presented in **Figures 6, 7, 8, & 9**.

7.4 Technical System Audits

The systems audit is an on-site review and inspection of the entire ambient air monitoring program to assess its compliance with established regulations governing the collection, analysis, validation, and reporting of ambient air quality data. Although not addressed in the NO/NO_x/NO₂ Validation Data Template of **Appendix A**, a technical systems audit is required once every three years for a SLAMS site and once for a PSD site. To provide uniformity in the evaluation, the criteria and procedures specified in EPA's Quality Assurance Handbook for Air Pollution Measurement Systems, Volume II, Section 2.0.11 will be applied.



DEC Air Monitoring & Quality Assurance Program
SOP –NO/NO_x/NO₂ Monitoring by Chemiluminescence

Revision 2, June 2016

Figure 6 Example NO Audit Results

NO monitor audit						
Site: NCore 809 Pioneer Rd, Fairbanks AK				Calibration: 5-Jan-16		
Date: January 13, 2016 8:15 -11:30 AST				Last QC check: 10-Jan-16		
Monitor: Thermo Sci 42i-TL NO-NO2-NOx analyzer, S/N 1405260738 (0-500 ppb range)				Time:		
Audit Device: EnviroNics 6103 Transfer Std/Gas Phase Titrator, S/N 4925				audit 11:02:00		
Type of Audit: Through sample manifold				instrument 11:02:04		
				das 11:02:11		
Audit Standard	DAS NO value	DAS NOx value	Time	(DAS NO-Audit)	Abs(DAS-Audit)/	Mean Abs
Set Pt (ppb)	5-min avg (ppb)	5-min avg (ppb)	(AST)	(ppb)	Audit*100	% Δ
0	-0.5	-0.4	8:50	-0.5		
400	376.9	393.0	10:20	-23.1	5.8	13.3
80	71.7	75.0	10:36	-8.3	10.4	
19	16.2	15.7	10:52	-2.8	14.7	
4	3.1	2.7	11:15	-0.9	22.5	
0	-0.6	-1	11:30	-0.6		

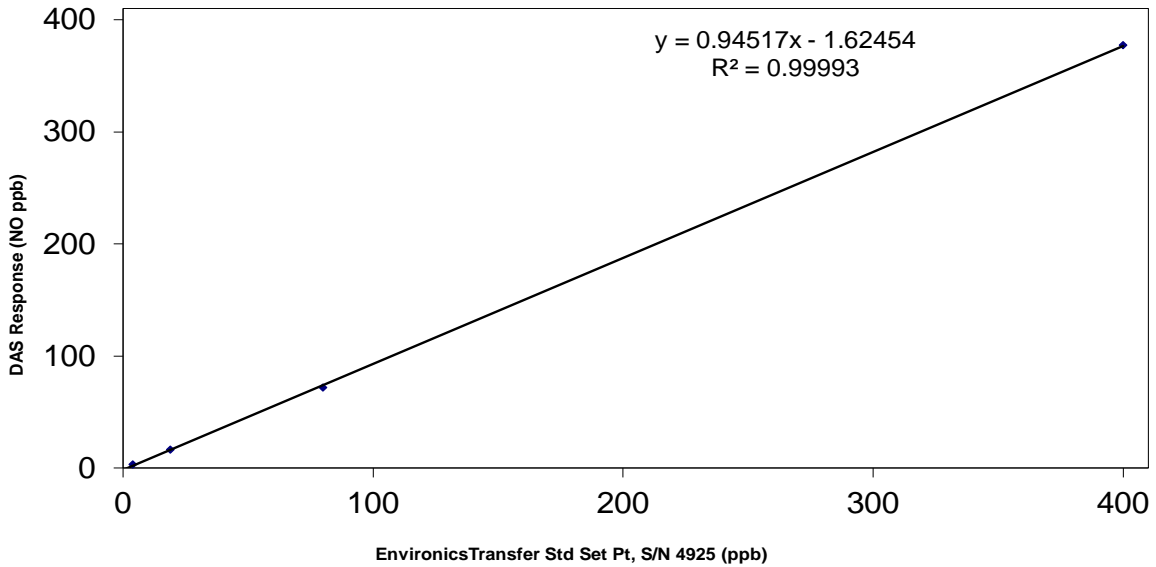



DEC Air Monitoring & Quality Assurance Program
 SOP –NO/NO_x/NO₂ Monitoring by Chemiluminescence

Revision 2, June 2016

Figure 7 Example NO_x Audit Results

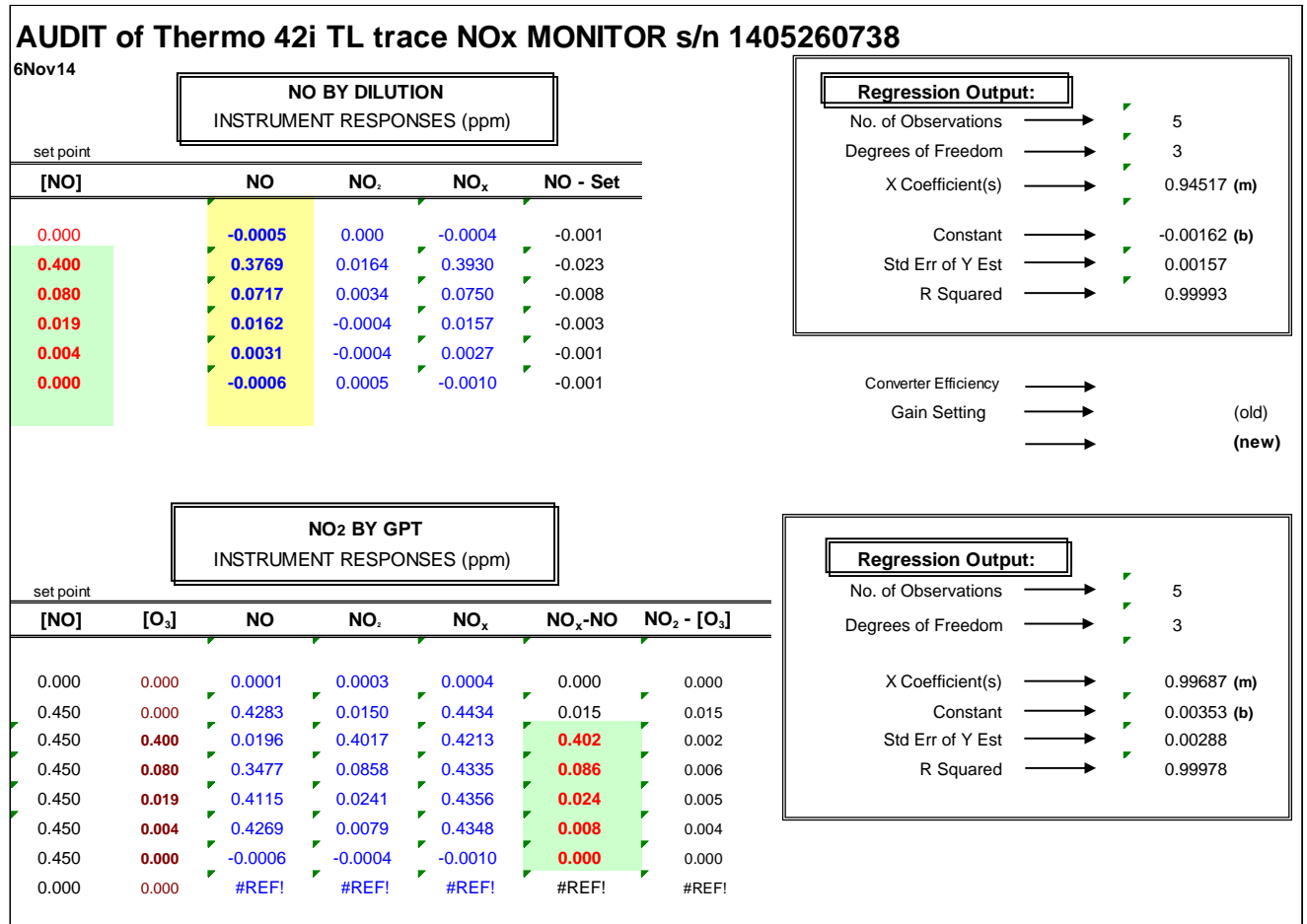



DEC Air Monitoring & Quality Assurance Program
SOP –NO/NO_x/NO₂ Monitoring by Chemiluminescence

Revision 2, June 2016

Figure 8 Example NO₂ Audit Results

NO ₂ monitor audit									
Site: NCore 809 Pioneer Rd, Fairbanks AK					Calibration: 5-Jan-16				
Date: January 13, 2016 12:00 -15:20 AST					Last QC check: 10-Jan-16				
Monitor: Thermo Sci 42i-TL NO-NO ₂ -NO _x analyzer, S/N 1405260738 (0-500 ppb range)					Time: audit 11:02:00				
Audit Device: Environics 6103 Transfer Std/Gas Phase Titrator, S/N 4925					instrument 11:02:04				
Type of Audit: Through sample manifold					das 11:02:11				
Audit conducted by first setting a flow of 450 ppb NO and recording analyzer and DAS values (row 15).									
With NO flowing @ 450 ppb (and O ₃ Control OFF), the O ₃ concentration was set at each desired audit point; 400, 80, 19, 4, 0 ppb (rows 16-20).									
The NO and O ₃ flows were then turned off and the zero point repeated (row 21).									
Audit Standard	DAS NO ₂ value	DAS NO value	DAS NO _x value	Time	(DAS-Audit)	Abs (DAS-Audit)/	Mean Abs		
Set Pt (ppb)	5-min avg (ppb)	5-min avg (ppb)	5-min avg (ppb)	(AST)	(ppb)	Audit*100	% Δ		
0	0.3	0.1	0.4	12:49	0.3				
450 NO	15	428.3	443.4	13:32					
400	401.7	19.6	421.3	13:48	1.7	0.42			
80	85.8	347.7	433.5	14:12	5.8	7.3			
19	24.1	411.5	435.6	14:29	5.1	26.8	33.0		
4	7.9	426.9	434.8	14:50	3.9	97.5			
0	-0.4	-0.6	-1.0	15:22	-0.4				

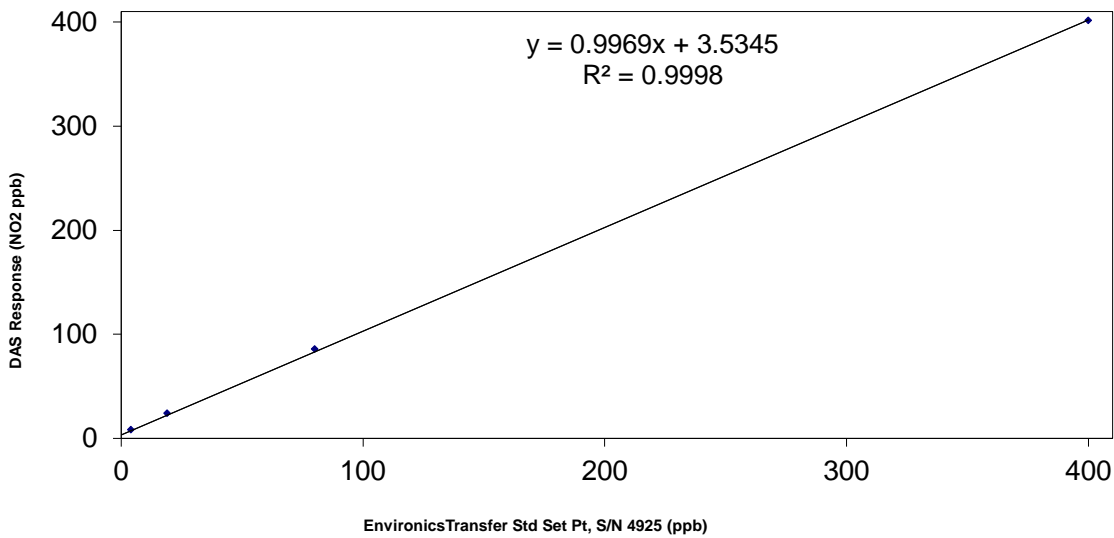
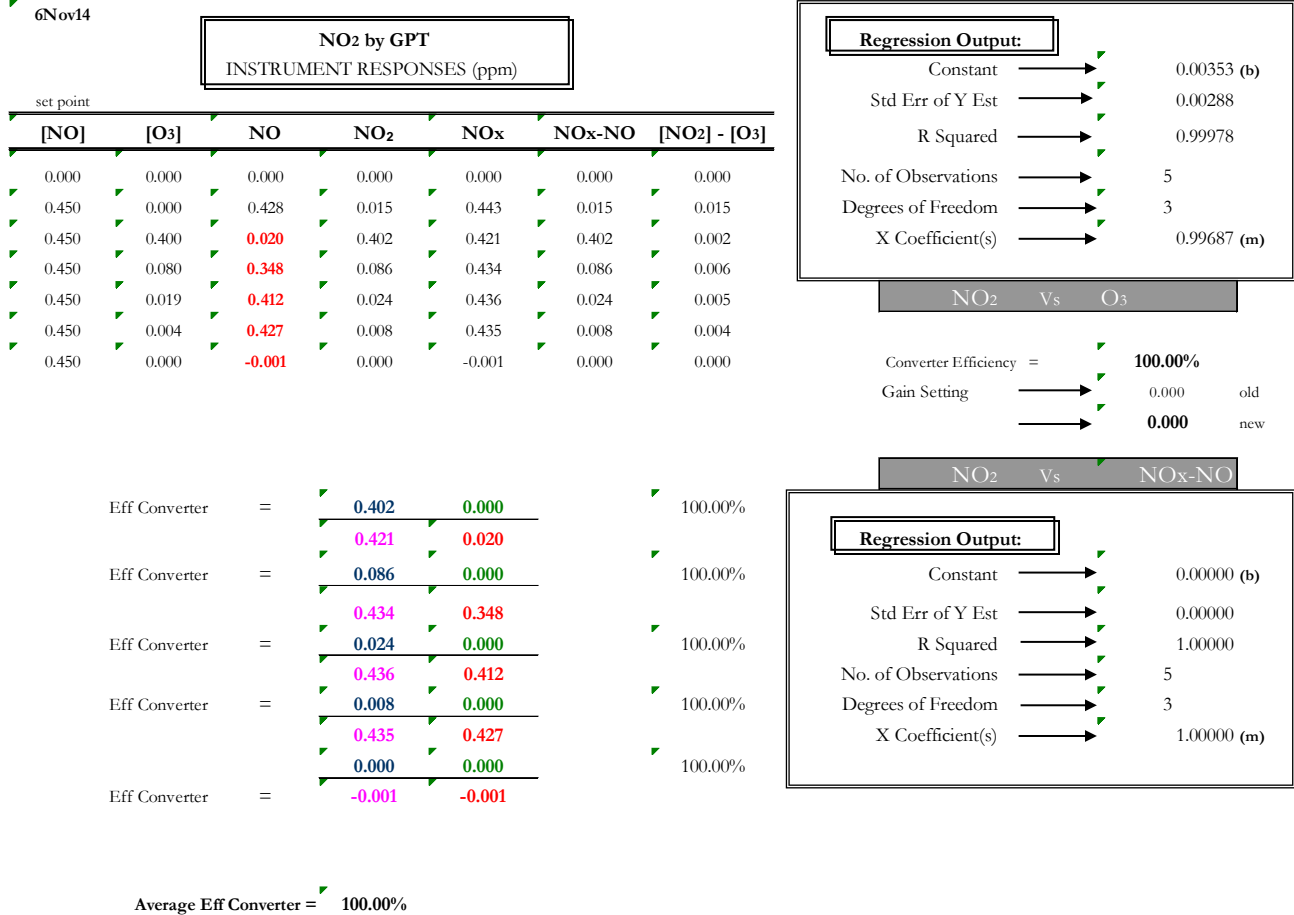



Figure 9 NO₂ Converter Efficiency Audit Results

AUDIT of Thermo 42i TL trace NO_x MONITOR s/n 1405260738



8. DATA REVIEW, VALIDATION AND REPORTING

To assure the NO/NO_x/NO₂ monitoring data are meeting EPA required data quality objectives (DQO), a strict protocol shall be followed for:

- Data Acquisition
- Daily Review
- Level 1 Data Review, Editing and Data Archiving
- Level 2 Data Review and Validation
- Data Submission to EPA AQS
- Annual Summary Reports

8.1 Data Acquisition

The NO/NO_x/NO₂ analyzer produces an electronic signal for each data channel. The electronic signals are equivalent to the measured NO/NO_x/NO₂ concentrations. These signals are transmitted to the primary DAS where the data are electronically translated to concentrations,



stored as 1-minute average concentrations and then calculated into 1-hour average concentrations. Depending on system capability, the on-site DAS may act as a server transmitting the data to a base computer or database server. Data management software on the database server will provide routine reporting and editing functions. This may include a near real-time data presentation to a Web-based air quality index (AQI) reporting system.

In addition to the primary DAS data record, concentration data are also recorded to a secondary DAS, which is typically an on-board data logger within the analyzer. The analyzer internal data logger is independent of the primary DAS and database server. The secondary system acts as a data backup system and provide for routine QC data comparisons to check for data processing and communication errors.

8.2 Daily Review

To assure on-going data quality and avoid unnecessary data losses, a cursory review of the monitoring data should be performed every business day. The operator or designated data manager will access the data from the DAS using the system's base computer or from the database server. The data will be reviewed for continuous function and determine if the data are characteristic of normal monitoring trends including typical diurnal and seasonal fluctuations. The most recent QC checks will be reviewed to assess data quality. This combined review is to determine if corrective action is required.

In terms of public health protection and for preparation of air quality alerts, the site operator or data manager shall also track daily NO/NO_x/NO₂ concentrations to alert the AMQA program manager if hourly or 3-hour concentrations approach or exceed the NAAQS standards.

8.3 Level 1 Data Review, Editing, and Data Archiving

8.3.1 Data Review

The level 1 review is a detailed review to assess data validity, edit out any erroneous data and prepare the data record for reporting to the EPA Air Quality System (AQS) database. This procedure is typically the responsible of the site operator or data manager who is knowledgeable of the day to day data collection effort and is typically performed on a monthly basis.

The procedure begins by compilation of all data and information required to assess and validate the data. This information shall include:

- raw data records from the primary DAS data management software, typically 1-hour average concentrations but 1-minute concentrations are also required for periods during QC checks and calibrations;
- raw data records from the secondary data logger, typically 1-hour average concentrations obtained by a direct download from the analyzer;



- records of all QC verifications for zero/span/precision checks, multi-point verifications, and calibrations;
- operational checklists, station logbook notes, maintenance logs, and/or electronic logs of all monitoring events for the reporting period; and
- the most recent results of any QA performance audits.

Once all the information is compiled the reviewer shall examine the data to determine if the data meets data quality objectives. Most data management software systems will allow the reviewer to examine the data in both a tabular view and a graphic view. A graphic examination of the data allows the reviewer to look for trends indicating suspect data or gaps indicating instrumental malfunctions. The tabular view allows the reviewer to observe specific data values. A comparison of hourly values shall be performed comparing the data record from primary DAS to the secondary data logger. This will indicate any data processing or communication errors. As the reviewer examines the data over the reporting period, the reviewer shall consult QC results, operational checklists, and station or electronic logs to identify and determine the cause of any periods of missing data, period of data that require invalidation, or data that are valid but require a qualifying explanation. Once identified the reviewer shall develop a written chronology documenting all events that affected data quality.

8.3.2 Data Editing

Once the detailed raw data review is complete, the site operator or data manager shall use the data management software to edit the data record. When the site operator or data manager begins the editing process, the data management software will create a new data file copying the raw data into an edited data folder.

Important Note: EPA data management practices requires that an original unedited “Raw Data” file be maintained for data archives.

The site operator or data manager shall edit the data record according to the findings of the review. The decision to validate or invalidate data shall be in accordance with the “Critical,” “Operational,” and “Systematic” criteria presented in the NO/NO_x/NO₂ Data Validation Template presented in **Appendix A**.

Typically data which fail to meet critical QC criteria are invalidated unless a technical explanation shows the analyzer data were accurate and precise despite QC results. For example, failed QC verification checks for zero/span/precision were due to a problem with the on-site calibration system and following repairs, the follow up QC verifications showed the analyzer to be functioning properly and providing accurate data.

Data collected during periods when there are deviations from “Operational” or “Systematic” criteria may or may not warrant invalidation. The invalidation will depend upon the affect to data quality and shall be a judgement call for the editor. In either case, an explanation for the action must be included in the data record. Invalidations shall be flagged with an EPA AQS null data code. The other data shall be flagged with an EPA AQS data qualifier code.



Guidance on AQS null codes and qualifier codes is available from the EPA website <https://www.epa.gov/aqs>. Most data management software systems will allow for editing notes. These explanations shall also be noted in the data chronology.

8.3.3 Data Archiving

Ambient air quality monitoring data used to demonstrate compliance with NAAQS or PSD regulations are legally considered as credible evidence. All data and related records used in the development of the final validated data set submitted to the EPA AQS database shall be maintained in a data archive system. These records shall include:

- copies of all station logbook, maintenance logs, operational or status checklists;
- the results of all QC checks and any QA performance audits performed during the reporting period;
- the comparison of the DAS primary data source to a secondary data source,
- all spreadsheets used for data and QC calculations
- the raw data file as recorded by the primary DAS;
- an edited data file annotated with AQS data null and qualifier codes with an explanation of missing, suspect, and invalidated data; and
- monitoring data chronology developed during the data review and editing process.

These records shall be maintained in accordance with the DEC's records retention policy.

8.4 Level 2 Data Review and Validation

Once the data has been compiled, edited, and annotated with the appropriate AQS null codes and qualifier codes, the preliminary report should be submitted to a colleague for a peer review. The second level review shall be conducted by a qualified air monitoring specialist independent of the site's day to day monitoring operations. The air monitoring specialist shall provide a thorough review of the raw data, edited data and all the supporting documentation to confirm that the data is accurate and complete. The reviewer shall examine the data record, all QC/QA results, and the data chronology to confirm that the periods of missing, invalidated or qualified data were correctly assessed. The reviewer shall also review all archived data records to determine if the documentation is complete. Any errors or deficiencies will be noted and compiled, then returned to the site operator or data manager for correction. The data set is to be corrected and resubmitted to the second level reviewer. Once the second reviewer is satisfied that the data set is accurate and complete, the second level reviewer, using the data management software, will validate the data set. The data management software will create new "Validated Data" set which is available to the system administrator for upload to EPA AQS database.

Important Note: Most data management software programs will have a hierarchical authorization protocol to allow specific users to make changes to the data at each stage



DEC Air Monitoring & Quality Assurance Program
SOP –NO/NO_x/NO₂ Monitoring by Chemiluminescence

Revision 2, June 2016

of data processing. The programs must also maintain an audit trail of all editing activities as part of the evidentiary documentation.

8.5 Data Submission to EPA AQS

The validated NO/NO_x/NO₂ data set will typically be reported to the EPA's AQS database on a quarterly basis if generated by a SLAM, NCore or SPM station. The data shall be submitted for each valid 1-hour average concentration for each of the NO/NO_x/NO₂ data channels. In addition to the 1-hour average concentrations, all the corresponding data precision and audit results for the reporting period are uploaded to AQS. Quarterly or monthly reports will be submitted within a time period specified by the database manager (preferably the end of the month following the month in which the data were collected), but absolutely no later than two and half months following the end of the respective quarter. Independent projects performed in support of a PSD permit application are not required to be reported to AQS but are typically submitted to DEC at the conclusion of the 1-year monitoring period.

8.6 Annual Summary Reports

As public outreach, the AMQA program will prepare an annual summary report of all monitoring sites. The report shall present:

- the description, location and the monitoring objectives for the site;
- a comparison of ambient air concentrations determined by the monitor program to the 1-hour NAAQS and the calculated design value for the site; and
- any applicable trend analysis related to meteorological or climatological conditions and/or source attribution.



DEC Air Monitoring & Quality Assurance Program
SOP –NO/NO_x/NO₂ Monitoring by Chemiluminescence

Revision 2, June 2016

9. REFERENCES

- 1) Technical Assistance Document (TAD) *For Precursor Gas Measurements in the NCore Multi-Pollutant Monitoring Network*, EPA-454/R 05-003, September 2005.
- 2) Title 40 CFR Part 50, Appendix F, *Measurement Principle and Calibration Procedure for Measurement of Nitrogen Dioxide in the Atmosphere (Gas Phase Chemiluminescence.)*
- 3) Title 40 CFR Part 53, *Ambient Air Monitoring Reference and Equivalent Methods, Subparts A and B*
- 4) Title 40 CFR Part 58, *Ambient Air Quality Surveillance, Subparts A, B, C, Appendices A, C, D, and F*
- 5) EPA *Quality Assurance Handbook for Air Pollution Measurement Systems*, Volume II, EPA-454/B-13-003, May 2013.
- 6) EPA *Traceability Protocol for Assay and Certification of Gaseous Standards*, EPA 600/R-012/533, May 2012.
- 7) EPA *Guideline on the meaning and the use of precision and bias data required by 40 CFR Part 58*, EPA-454/B-07-001, January 2007. Data Assessment Statistical Calculator
- 8) ADEC *Quality Assurance Project Plan for the State of Alaska Air Monitoring & Quality Assurance Program*, February 23, 2010.
- 9) Thermo-Fisher Environmental Instruments Division,. *Model 42i-TL Instruction Manual Chemiluminescence NO/NO_x/NO₂ Analyzer*, December 2007.
- 10) Environics, Inc. *Model 6103 Multi-Gas Calibrator, User's Guide and Technical Service Manual*, Revision 5 March, 2007
- 11) EPA Memorandum, "*Revision to the Zero Drift Acceptance Criteria in the QA Handbook*" Lewis Weinstock, Office of Air Quality Planning and Standards, June 3, 2013.



10. DEFINITIONS OF ACRONYMS & SYMBOLS

AMQA	“Air Monitoring & Quality Assurance” program within the Alaska Department of Environmental Conservation, Air Quality Division
AST	common abbreviation for “Alaska Standard Time,” the EPA requires all air monitoring activities be conducted and the data recorded in accordance with local standard time traceable to US Official Time provided by NIST and the US Naval Observatory
AQS	“Air Quality System” is the database which contains ambient air pollution data collected by the EPA, state, local, and tribal air pollution control agencies.
CFR	government abbreviation for “Code of Federal Regulation,” which is used to reference federal regulations for example, 40 CFR 58 is the reference for Title 40, Code of Federal Regulations, Part 58.
° C	chemical abbreviation for a unit of temperature expressed as “degrees Celsius”
DAS	common abbreviation for “data acquisition system,” which for the purposes of this manual, represents a computer-based system that records and stores electronic signals from the NO/NO _x /NO ₂ analyzer, and provides programmed functions to perform automated quality control checks
DEC	government abbreviation for “Alaska Department of Environmental Conservation”
DQO	government abbreviation for “data quality objectives”
LED	electronic abbreviation for “light emitting diode”
LDL	chemical abbreviation for “Lower Detectable Limit” used when discussing instrumental analysis
MFC	instrumental abbreviation for “Mass Flow Controller,” an electronic device used in gas analyzers and calibration instruments to detect and precisely control the flow of gas (either pollutant gas and/or zero air) through a monitoring system
mm Hg	chemical abbreviation for a unit of pressure expressed as “millimeters of mercury”
NAAQS	government abbreviation for “National Ambient Air Quality Standards,” which are air quality standards established in regulation under 40 CFR 50 to protect human health and the environment



DEC Air Monitoring & Quality Assurance Program
SOP –NO/NO_x/NO₂ Monitoring by Chemiluminescence

Revision 2, June 2016

NCORE	an EPA program to establish a national multi pollutant monitoring network that integrates several advanced measurement systems for particles, precursor pollutant gases, and meteorology
NIST	government abbreviation for the “National Institute of Standards and Technology”
NO ₂	chemical abbreviation for nitrogen dioxide
NO	chemical abbreviation for nitric oxide
NO _x	chemical abbreviation for total oxides of nitrogen
OAQPS	EPA “Office of Air Quality Planning and Standards”
ppb	chemical abbreviation for a unit of chemical concentrations expressed as “parts per billion” (Note, because NO/NO _x /NO ₂ is measured as a gas at ambient conditions, for purposes of this document, parts per billion are expressed on a volumetric basis, ppbv)
ppm	chemical abbreviation for a unit of chemical concentration expressed as “parts per million” (Note, because NO/NO _x /NO ₂ is measured as a gas at ambient conditions, for purposes of this document, parts per million are expressed on a volumetric basis, ppmv)
PSD	government abbreviation for “Prevention of Significant Deterioration,” which is federal regulations under 40 CFR 52 promulgated to protect existing ambient air quality through the permitting process. If a facility’s emissions trigger these regulations, an assessment of ambient air quality is required through pollutant dispersion modeling and/or ambient air quality and meteorological monitoring
QA	common abbreviation for “quality assurance”
QAPP	EPA abbreviation for “Quality Assurance Project Plan”
QC	common abbreviation for “quality control”
SLAMS	EPA abbreviation for “State and Local Air Monitoring Station”
SO ₂	chemical abbreviation for sulfur dioxide
SOP	common abbreviation for “Standard Operating Procedure”
SPMS	EPA abbreviation for “Special Purpose Monitoring Station”
Std. Dev.	statistical abbreviation for “standard deviation”



DEC Air Monitoring & Quality Assurance Program
SOP –NO/NO_x/NO₂ Monitoring by Chemiluminescence

Revision 2, June 2016

- STP chemical abbreviation for “standard temperature and pressure” (Note: the EPA, when requiring a correction to a standard temperature and pressure, uses 25 ° C and 760 mm Hg)
- TAD EPA abbreviation for “Technical Assistance Document”
- USEPA government abbreviation for “United States Environmental Protection Agency,” often shortened to “EPA”



DEC Air Monitoring & Quality Assurance Program
SOP –NO/NO_x/NO₂ Monitoring by Chemiluminescence

Revision 2, June 2016

Appendix A
NO/NO_x/NO₂ Data Validation Template

Appendix A NO/NO_x/NO_x Data Validation Template

1) Requirements (NO ₂)	2) Frequency	3) Acceptance Criteria	Information/ Action
CRITICAL CRITERIA- NO₂			
<i>One Point QC Check Single Analyzer</i>	1/ 2 weeks	≤ ± 15% (percent difference)	1 & 2) 40 CFR Part 58 App. A Sec. 3.2 3) Recommendation based on DQO in 40 CFR Part 58 App. A Sec. 2.3.1.5 QC Check Conc. range 0.01-0.10 ppm Relative to routine concentrations
Zero/span check	1/ 2 weeks	Zero drift ≤ ± 1.5 ppb Span Drift ≤ ± 10%	1 & 2) QA Handbook Volume 2 Section 12.3 3) Recommendation and related to DQO
<i>Converter Efficiency</i>	During multi-point calibrations, span and audit 1/ 2 weeks	(≥ 96%) 96%-104%	1) 40 CFR Part 50 App. F Sec. 1.5.10 and 2.4.10 2) Recommendation 3) 40 CFR Part 50 App. F Sec. 1.5.10 and 2.4.10 Regulation states ≥ 96%, 96-104% is a recommendation
OPERATIONAL CRITERIA- NO₂			
Shelter Temperature Range	Daily (hourly values)	20 to 30° C. (Hourly avg.) Per manufacturer's specifications if designated to a wider temperature range	1, 2 & 3) QA Handbook Volume 2 Section 7.2.2 Generally the 20-30° C range will apply but the most restrictive operable range of the instruments in the shelter may also be used as guidance. FRM/FEM list found on AMTIC provides temp. range for given instrument. FRM/FEM monitor testing is required at 20-30° C range per 40 CFR Part 53.32
Shelter Temperature Control	Daily (hourly values)	≤ ± 2° C SD over 24 hours	1, 2 & 3) QA Handbook Volume 2 Section 7.2.2
Shelter Temperature Device Check	1/ 6 mo	± 2° C of standard	1, 2 & 3) QA Handbook Volume 2 Section 7.2.2
<i>Annual Performance Evaluation Single Analyzer</i>	<i>Every site 1/ year 25% of sites quarterly</i>	Percent difference of audit levels 3-10 ≤ ± 15%	1) 40 CFR part 58 App. A Sec. 3.2.2 2) 40 CFR part 58 App. A Sec. 3.2.2 3) Recommendation- 3-audit concentrations not including zero. AMTIC guidance 2/17/2011 http://www.epa.gov/ttn/amtic/cpreldoc.html
<i>Federal Audits (NPAP)</i>	1/ year at selected sites 20% of sites audited	Audit levels 1 & 2 ± 1.5 ppb difference all other levels percent difference ± 15%	1) 40 CFR Part 58 App. A Sec. 2.4 2) NPAP adequacy requirements on AMTIC 3) NPAP QAPP/ SOP
<i>Verification/ Calibration</i>	Upon receipt/adjustment/repair/ Installation/moving 1/ 6 months if manual zero/span Performed biweekly 1/ year if continuous zero/span performed daily	Instrument residence time ≤ 2 min. Dynamic parameter ≥ 2.75 ppm-min. All points within ± 2% of calibration range of best-fit straight line	1) 40 CFR Part 50 APP. F 2 & 3) Recommendation Multi-point calibration (0 and 4 upscale points)
<i>Gaseous Standards</i>	All gas cylinders	<u>NIST Traceable</u>	1) 40 CFR Part 50 App. F Section 1.3.1

1) Requirements (NO ₂)	2) Frequency	3) Acceptance Criteria	Information/ Action
		(e.g., EPA Protocol Gas) 50-100 ppm of NO in Nitrogen with < 1 ppm NO ₂	2) NA Green Book 3) 40 CFR Part 50 App. F Section 1.3.1 Gas producer used must participate in EPA Ambient Air Protocol Gas Verification Program. 40 CFR Part 58 App. A Sec. 2.6.1
<i>Zero Air/ Zero Air Check</i>	1/ year	Concentrations below LDL	1) 40 CFR Part 50 App. F Section 1.3.2 2 & 3) Recommendation
Gas Dilution Systems	1/ year or after failure of 1 point QC check or performance evaluation	Accuracy ± 2%	1, 2 & 3) Recommendation based on SO ₂ requirement in 40 CFR Part 50 App. A-1 Sec. 4.1.2
Detection (FEM/FRMs)			
<i>Noise</i>	NA	<i>0.005 ppm</i>	1) 40 CFR Part 53.23 (b) (definition & procedure) 2) NA 3) 40 CFR Part 53.20 Table B-1
<i>Lower detectable level</i>	1/ year	<i>0.01 ppm</i>	1) 40 CFR Part 53.23 (c) (definition & procedure) 2) Recommendation 3) 40 CFR part 53.20 Table B-1
SYSTEMATIC CRITERIA- NO₂			
<i>Sampler/ Monitor</i>	NA	<i>Meets requirements listed in FRM/ FEM designation</i>	1) 40 CFR Part 58 App. C Section 2.1 2) NA 3) 40 CFR Part 53 & FRM/FEM method list
<i>Standard Reporting Units</i>	<i>All data</i>	<i>Ppb (final units in AQS)</i>	1, 2 & 3) 40 CFR Part 50 App. S Sec. 2 (c)
<i>Rounding convention for data reported to AQS</i>	<i>All data</i>	<i>1 place after decimal with digits to right truncated</i>	1, 2 & 3) 40 CFR Part 50 App. S Sec. 4.2 (a)
<i>Completeness</i>	<i>Annual Standard</i>	<i>≥ 75% hours in year</i>	1) 40 CFR Part 50 App. S Sec. 3.1 (b) 2) 40 CFR Part 50 App. S Sec. 3.1 (a) 3) 40 CFR Part 50 App. S Sec. 3.1 (b)
	<i>1-hour standard</i>	<i>1) 3 consecutive calendar years of complete data 2) 4 quarters complete in each year 3) ≥75% sampling days in quarter 4) ≥ 75% of hours in a day</i>	1) 40 CFR Part 50 App. S Sec. 3.2 (b) 2) 40 CFR Part 50 App. S Sec. 3.2 (a) 3) 40 CFR Part 50 App. S Sec. 3.2 (b)
<i>Sample Residence Time Verification</i>	1/ year	<i>< 20 seconds</i>	1) 40 CFR Part 58 App. E, Sec. 9 (c) 2) Recommendation 3) 40 CFR Part 58 App. E, Sec. 9 (c)
<i>Sample Probe, Inlet, Sampling train</i>	<i>All Sites</i>	<i>Borosilicate glass (e.g. Pyrex®) or Teflon®</i>	1, 2 & 3) 40 CFR Part 58 App. E, Sec. 9 (a) FEP and PFA have been accepted as equivalent material to Teflon. Replacement or cleaning is suggested as 1/ year and more frequent if pollutant load or contamination dictates
Siting	1/ year	<i>Meets siting criteria or waiver documented</i>	1) 40 CFR Part 58 App. E, Sec. 2-6 2) Recommendation 3) 40 CFR Part 58 App. E, Sec. 2-6

1) Requirements (NO₂)	2) Frequency	3) Acceptance Criteria	Information/ Action
<i>Precision (using 1-point QC checks)</i>	<i>Calculated annually and as appropriate for design value estimates</i>	<i>90% CL CV ≤ 15%</i>	1) 40 CFR Part 58 App. A Sec. 2.3.1.5 & 3.2.1 2) 40 CFR Part 58 App. A Sec. 4 (b) 3) 40 CFR Part 58 App. A Sec. 4.1.2
<i>Bias (using 1-point QA checks)</i>	<i>Calculated annually and as appropriate for design value estimates</i>	<i>95% CL ≤ ± 15%</i>	1) 40 CFR Part 58 App. A Sec. 2.3.1.5 & 3.2.1 2) 40 CFR Part 58 App. A Sec. 4 (b) 3) 40 CFR Part 58 App. A Sec. 4.1.3
<i>Annual PE Primary QA Organization (PQAO) Evaluation</i>	1/ year	<i>95% of audit percent differences fall within the one point QC check 95% probability intervals at PQAO level of aggregation</i>	1) 40 CFR Part 58 App. A Sec. 3.2.2 2) Recommendation 3) 40 CFR Part 58 App. A Sec. 4.1.4 & 4.1.5